

## Z4GP206L-HF Thru. Z4GP210L-HF

Reverse Voltage: 600 to 1000 Volts

Forward Current: 2.0 A

RoHS Device

Halogen free



### Features

- Internal structure with GPRC (Glass passivated rectifier chip) inside.
- Lead less chip form, no lead damage.
- Low power loss, High efficiency.
- High current capability.
- Plastic package has Underwriters Laboratory Flammability Classification 94V-0 .

### Mechanical data

- Case: Packed with FRP substrate and epoxy underfilled.
- Terminals: Pure Tin plated (Lead-Free), solderable per MIL-STD-750, method 2026.
- Polarity: Laser marking symbols
- Weight: 0.11 gram

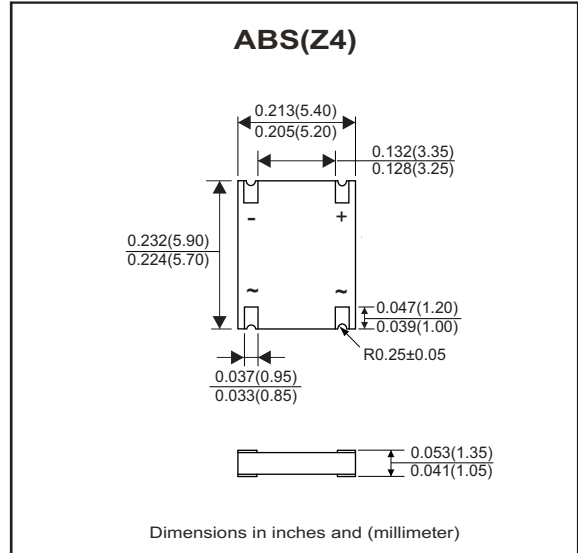

### Circuit Diagram

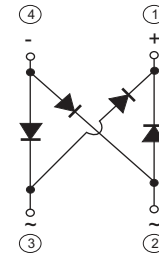

### Absolute Maximum Rating (at TA=25°C unless otherwise noted)

Parameter	Symbol	Z4GP206L-HF	Z4GP208L-HF	Z4GP210L-HF	Unit
Repetitive Peak Reverse Voltage	V <sub>RRM</sub>	600	800	1000	V
Average Forward Current	I <sub>(AV)</sub>	2.0			A
Peak Forward Surge Current, 8.3mS single half sine-wave, superimposed on rated load (JEDEC Method)	I <sub>FSM</sub>	60			A
Operating Temperature Range	T <sub>J</sub>	-55 to +175			°C
Storage Temperature Range	T <sub>STG</sub>	-55 to +175			°C

### Electrical Characteristics (at TA=25°C unless otherwise noted)

Parameter	Symbol	Conditions	Min.	Typ.	Max.	Unit
Forward Voltage	V <sub>F</sub>	I <sub>F</sub> = 2.0A	-	0.92	0.95	V
Repetitive peak reverse current	I <sub>RRM</sub>	V <sub>R</sub> =Max. V <sub>RRM</sub> , T <sub>a</sub> =25°C	-	0.08	5	uA
Current squared time	I <sup>2</sup> t	t<8.3ms, T <sub>a</sub> = 25°C	-	14.9	-	A <sup>2</sup> S
Junction capacitance	C <sub>J</sub>	V <sub>R</sub> =4V, f=1.0MHz	-	35	-	pF
Thermal resistance	R <sub>th(JA)</sub>	Junction to ambient (Note)	-	80	-	°C/W
	R <sub>th(JL)</sub>	Junction to lead (Note)	-	20	-	°C/W

Notes: 1. Mounted on P.C.B with 1.5\*1.0mm copper pads..

Company reserves the right to improve product design , functions and reliability without notice.

REV:A

## RATING AND CHARACTERISTIC CURVES (Z4GP206L-HF Thru. Z4GP210L-HF)

Fig.1- Forward Current Derating Curve

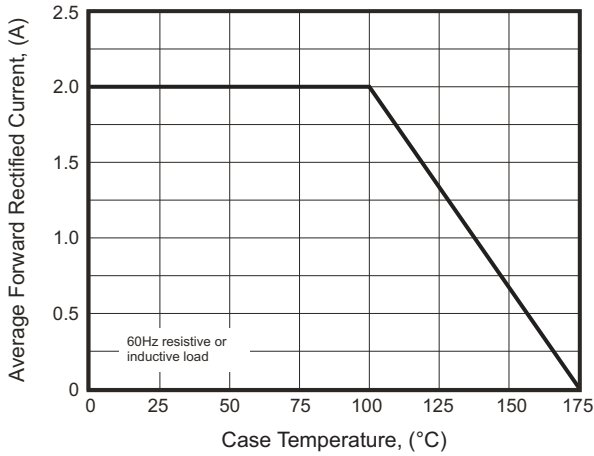

Fig.2- Maximum Non-Repetitive Peak Forward Surge Current

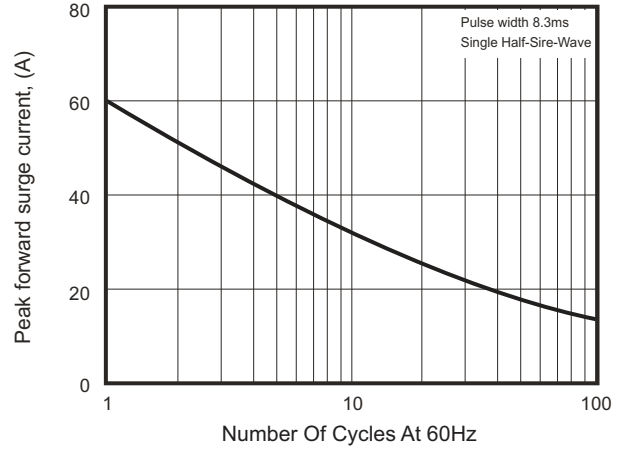

Fig.3- Typical Instantaneous Forward Characteristics

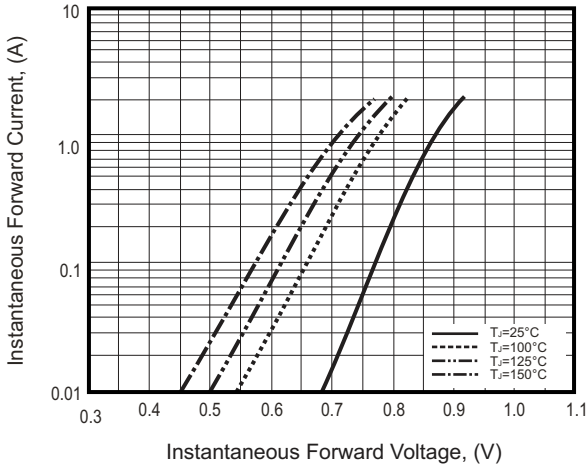

Fig.4- Typical Reverse Characteristics

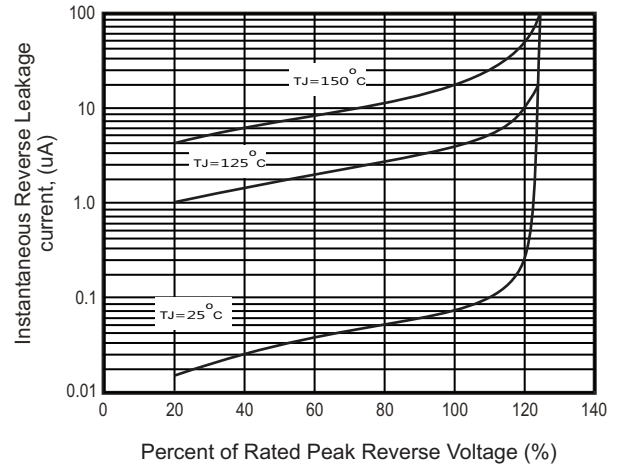
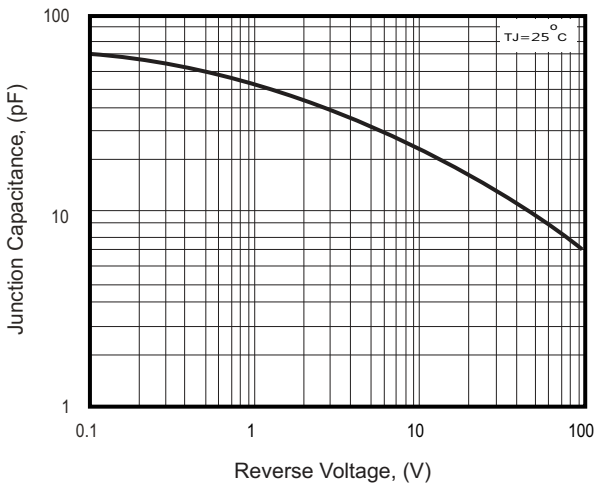

Fig.5 - Typical Junction Capacitance



Company reserves the right to improve product design, functions and reliability without notice.

REV:A

## Reel Taping Specification

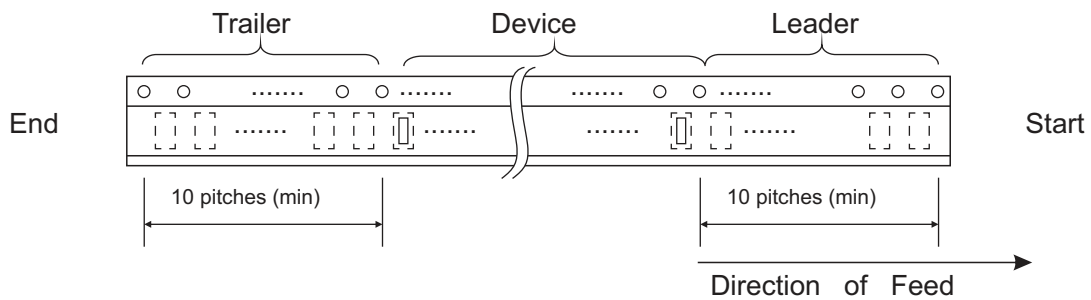
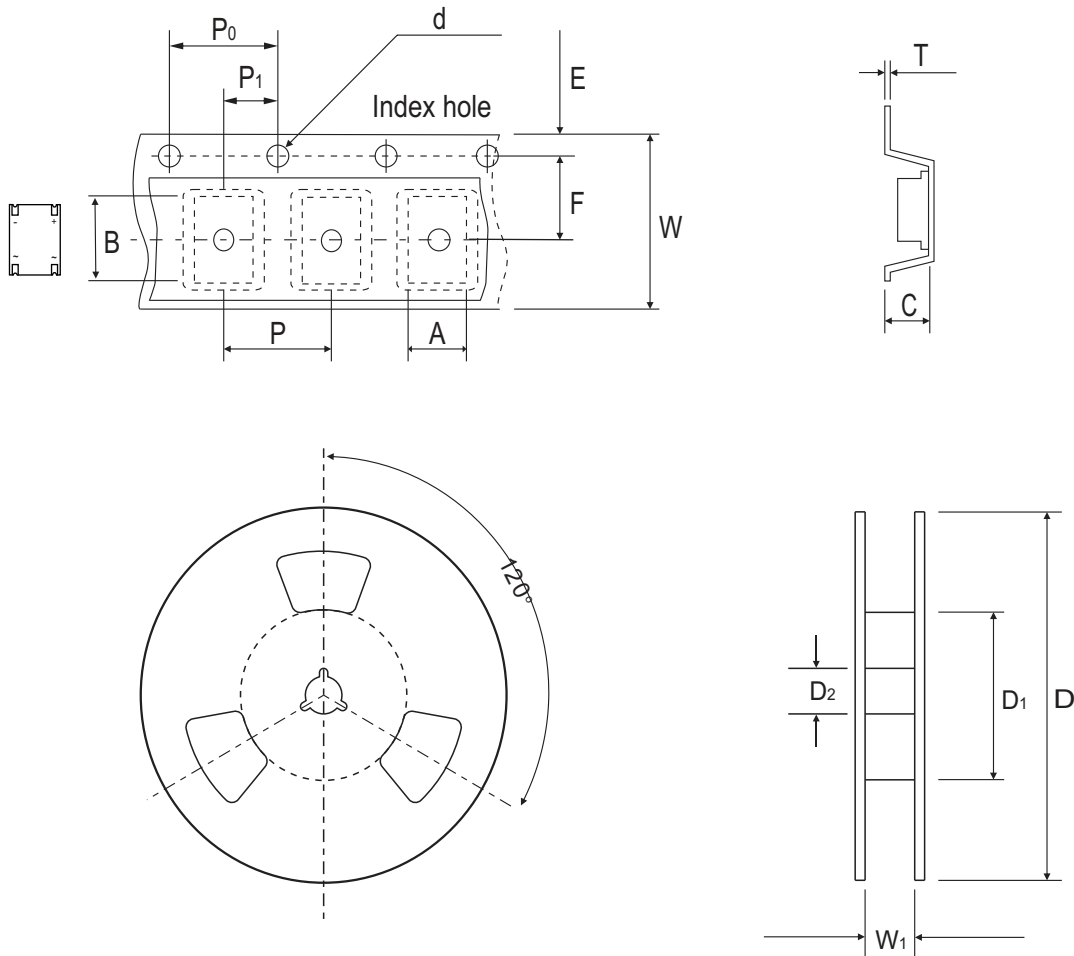

ABS(Z4)	SYMBOL	A	B	C	d	D	D <sub>1</sub>	D <sub>2</sub>
	(mm)	5.65 ± 0.10	6.15 ± 0.10	1.45 ± 0.10	1.50 ± 0.10	330 ± 2.00	50.0 MIN.	13.0 ± 0.50
	(inch)	0.222 ± 0.004	0.242 ± 0.004	0.057 ± 0.004	0.059 ± 0.004	12.992 ± 0.079	1.969 MIN.	0.512 ± 0.020

ABS(Z4)	SYMBOL	E	F	P	P <sub>0</sub>	P <sub>1</sub>	W	W <sub>1</sub>
	(mm)	1.75 ± 0.10	5.50 ± 0.05	8.00 ± 0.10	4.00 ± 0.10	2.00 ± 0.10	12.00 ± 0.30	14.4 MAX.
	(inch)	0.069 ± 0.004	0.217 ± 0.002	0.315 ± 0.004	0.157 ± 0.004	0.079 ± 0.004	0.472 ± 0.012	0.567 MAX.

Company reserves the right to improve product design, functions and reliability without notice.

## Marking Code

Part Number	Marking Code
Z4GP206L-HF	Z4GP20JL
Z4GP208L-HF	Z4GP20KL
Z4GP210L-HF	Z4GP20ML

Z4GP = Series code  
 20 = Amps class(2.0A)  
 J = Voltage Class  
   J = 600V  
   K = 800V  
   M = 1000V  
 L = Low VF  
 . = Halogen- free type

Y = Last digit of the year  
 0 = 2010  
 1 = 2011  
 2 = 2012

WW = Mfg week  
 01 = First week  
 02 = Second week  
 03 = Third week

## Suggested PAD Layout

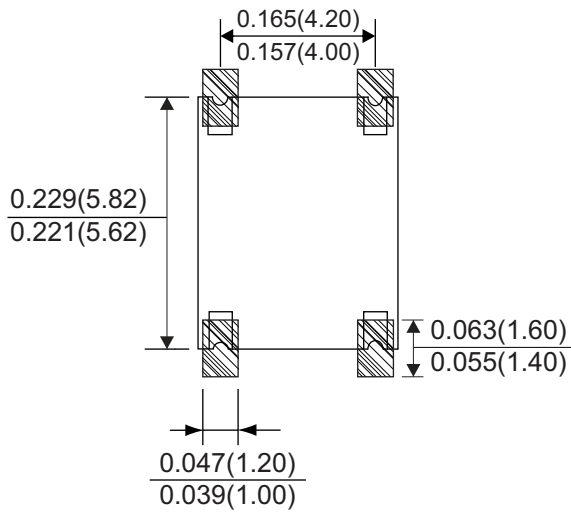

## Standard Packaging

Case Type	REEL PACK	
	REEL ( pcs )	Reel Size (inch)
ABS(Z4)	5,000	13