

TPS54A20 SWIFT™ Step-Down Converter Evaluation Module User's Guide



ABSTRACT

This user's guide contains information for the TPS54A20EVM-770 evaluation module (PWR770) as well as for the TPS54A20 dc/dc converter. Also included are the performance specifications, the schematic, and the bill of materials for the TPS54A20EVM-770.

Table of Contents

1 Introduction	2
2 Test Setup and Results	4
3 Board Layout	14
4 Schematic and Bill of Materials	15
5 Revision History	18

List of Figures

Figure 2-1. TPS54A20EVM-770 Efficiency.....	6
Figure 2-2. TPS54A20EVM-770 Low Current Efficiency.....	6
Figure 2-3. TPS54A20EVM-770 Load Regulation.....	7
Figure 2-4. TPS54A20EVM-770 Line Regulation.....	7
Figure 2-5. TPS54A20EVM-770 Transient Response.....	8
Figure 2-6. TPS54A20EVM-770 Loop Response.....	8
Figure 2-7. TPS54A20EVM-770 Output Ripple, 0 A Load.....	9
Figure 2-8. TPS54A20EVM-770 Output Ripple, 5 A Load.....	9
Figure 2-9. TPS54A20EVM-770 Output Ripple, 10 A Load.....	10
Figure 2-10. TPS54A20EVM-770 Input Ripple, 0 A Load.....	10
Figure 2-11. TPS54A20EVM-770 Input Ripple, 5 A Load.....	11
Figure 2-12. TPS54A20EVM-770 Input Ripple, 10 A Load.....	11
Figure 2-13. TPS54A20EVM-770 Start-Up Relative to V_{IN}	12
Figure 2-14. TPS54A20EVM-770 Start-Up Relative to Enable.....	12
Figure 2-15. Thermal Image.....	13
Figure 3-1. TPS54A20EVM-770 Top-Side Assembly.....	14
Figure 3-2. TPS54A20EVM-770 Top-Side Layout.....	14
Figure 3-3. TPS54A20EVM-770 Internal Layer-1 Layout.....	14
Figure 3-4. TPS54A20EVM-770 Internal Layer-2 Layout.....	14
Figure 3-5. TPS54A20EVM-770 Bottom-Side Layout.....	15
Figure 4-1. TPS54A20EVM-770 Schematic.....	16

List of Tables

Table 1-1. Input Voltage and Output Current Summary.....	3
Table 1-2. TPS54A20EVM-770 Performance Specification Summary.....	3
Table 2-1. EVM Connectors and Test Points.....	4
Table 4-1. TPS54A20EVM-770 Bill of Materials.....	16

Trademarks

All trademarks are the property of their respective owners.

1 Introduction

1.1 Before You Begin

The following warnings and cautions are noted for the safety of anyone using or working close to the TPS54A20EVM-770. Observe all safety precautions.

**Warning**

The TPS54A20EVM-770 circuit module may become hot during operation due to dissipation of heat. Avoid contact with the board. Follow all applicable safety procedures applicable to your laboratory.

**Caution**

Do not leave the EVM powered when unattended.

WARNING

The circuit module has signal traces, components, and component leads on the bottom of the board. This may result in exposed voltages, hot surfaces or sharp edges. Do not reach under the board during operation.

CAUTION

The circuit module may be damaged by over temperature. To avoid damage, monitor the temperature during evaluation and provide cooling, as needed, for your system environment.

CAUTION

Some power supplies can be damaged by application of external voltages. If using more than 1 power supply, check your equipment requirements and use blocking diodes or other isolation techniques, as needed, to prevent damage to your equipment.

1.2 Background

The TPS54A20 dc/dc converter is a two-phase synchronous series capacitor buck converter designed to provide up to a 10-A output. The input (V_{IN}) is rated for 8 V to 14 V. Rated input voltage and output current range for the evaluation module are given in [Table 1-1](#). This evaluation module is designed to demonstrate the small printed-circuit-board areas that may be achieved when designing with the TPS54A20 regulator. The switching frequency is externally set at a nominal 2 MHz for each side, 4 MHz effective. The high-side and low-side MOSFETs are incorporated inside the TPS54A20 package along with the gate drive circuitry. The low drain-to-source on-resistance of the MOSFET allows the TPS54A20 to achieve high efficiencies and helps keep the junction temperature low at high output currents. The compensation components are internal to the integrated circuit (IC), and an external divider allows for an adjustable output voltage. Additionally, the TPS54A20 provides adjustable slow start and undervoltage lockout inputs. The absolute maximum input voltage is 15 V while switching and 17 V for non-switching conditions.

Table 1-1. Input Voltage and Output Current Summary

EVM	INPUT VOLTAGE RANGE	OUTPUT CURRENT RANGE
TPS54A20EVM-770	$V_{IN} = 9.2 \text{ V to } 14 \text{ V}$	0 A to 10 A

1.3 Performance Specification Summary

A summary of the TPS54A20EVM-770 performance specifications is provided in [Table 1-2](#). Specifications are given for an input voltage of $V_{IN} = 12 \text{ V}$ and an output voltage of 1.2 V, unless otherwise specified. The TPS54A20EVM-770 is designed and tested for $V_{IN} = 9.2 \text{ V to } 14 \text{ V}$. The ambient temperature is 25°C for all measurements, unless otherwise noted.

Table 1-2. TPS54A20EVM-770 Performance Specification Summary

SPECIFICATION	TEST CONDITIONS	MIN	TYP	MAX	UNIT
V_{IN} voltage range		9.2	12	14	V
V_{IN} start voltage			9.39		V
V_{IN} stop voltage			9.14		V
Output voltage setpoint			1.2		V
Output current range	$V_{IN} = 9.2 \text{ V to } 14 \text{ V}$	0		10	A
Line regulation	$I_O = 5 \text{ A}, V_{IN} = 9.2 \text{ V to } 14 \text{ V}$		$\pm 0.04\%$		
Load regulation	$V_{IN} = 12 \text{ V}, I_O = 0 \text{ A to } 10 \text{ A}$		$\pm 0.03\%$		
Load transient response	$I_O = 0 \text{ A to } 9 \text{ A}$	Voltage change	-60		mV
		Recovery time	60		μs
	$I_O = 9 \text{ A to } 0 \text{ A}$	Voltage change	60		mV
		Recovery time	60		μs
Loop bandwidth	$V_{IN} = 12 \text{ V}, I_O = 5 \text{ A}$		280		kHz
Phase margin	$V_{IN} = 12 \text{ V}, I_O = 5 \text{ A}$		45		degree
Input ripple voltage	$I_O = 10 \text{ A}$		90		mVPP
Output ripple voltage	$I_O = 10 \text{ A}$		20		mVPP
Output rise time			512		μs
Operating frequency			2		MHz
Maximum efficiency	TPS54A20EVM-770, $V_{IN} = 9 \text{ V}, I_O = 5 \text{ A}$		84.7%		

1.4 Modifications

These evaluation modules are designed to provide access to the features of the TPS54A20. Some modifications can be made to this module.

1.4.1 Output Voltage Setpoint

The output voltage is set by the resistor divider network of R9 ($R_{(TOP)}$) and R7 ($R_{(BOT)}$). R7 is fixed at 14.3 k Ω . To change the output voltage of the EVM, it is necessary to change the value of resistor R9. Changing the value

of R9 can change the output voltage above the 0.508 V reference voltage V_{REF} . The value of R9 for a specific output voltage can be calculated using [Equation 1](#).

$$R_{(TOP)} = \frac{R_{(BOT)} \times (V_{OUT} - V_{REF})}{V_{REF}} \quad (1)$$

1.4.2 On Time

The TON pin requires a resistor to set the nominal on-time and to support the input voltage feed forward circuit. The resistance value used also influences the internal ramp in the controller. Use [Equation 2](#) for selecting the TON resistor.

$$R_{(TON)} = 3 \text{ k} + 15 \text{ k} \times V_{OUT} \quad (2)$$

The R_{TON} resistor selected for this design example is 22.1 k Ω . During startup, the converter uses the nominal on-time programmed through TON. The phase lock loop (PLL) is only activated after startup is complete. When the PLL is engaged, the on-time is adjusted. If the nominal on-time programmed through the TON pin is not close to the on-time when the PLL is engaged, the SYNC range of the device may be reduced. The TON resistor can also be adjusted to tune the controller. Lowering the R_{TON} value will increase the internal ramp height. This will reduce the converter's sensitivity to noise and jitter but it will also reduce the transient response capabilities of the converter.

1.4.3 Adjustable UVLO

The undervoltage lockout (UVLO) can be adjusted externally using R2 ($R_{EN(TOP)}$) and R3 ($R_{EN(BOT)}$). The EVM is set for a start voltage of 9.385 V and a stop voltage of 9.144 V using R2 = 80.6 k Ω and R3 = 12.4 k Ω . Use [Equation 3](#) and [Equation 4](#) to calculate required resistor values for different start and stop voltages. $I_{EN(FALL)} = 4 \mu\text{A}$, $I_{EN(RISE)} = 1 \mu\text{A}$ and $V_{EN} = 1.23 \text{ V}$

$$R_{EN(TOP)} = \frac{V_{IN(RISE)} - V_{IN(FALL)}}{I_{EN(FALL)} - I_{EN(RISE)}} \quad (3)$$

$$R_{EN(BOT)} = \frac{R_{EN(TOP)} \times V_{EN}}{V_{IN(FALL)} - V_{EN} + R_{EN(TOP)} \times I_{EN(FALL)}} \quad (4)$$

2 Test Setup and Results

This section describes how to properly connect, set up, and use the TPS54A20EVM-770 evaluation module. The section also includes test results typical for the evaluation module and covers efficiency, output voltage regulation, load transients, loop response, output ripple, input ripple, and start-up.

2.1 Input/Output Connections

The TPS54A20EVM-770 is provided with input/output connectors and test points as shown in [Table 2-1](#). A power supply capable of supplying greater than 2 A must be connected to J1 through a pair of 20 AWG wires or better. The load must be connected to J4 through a pair of 20 AWG wires or better. The maximum load current capability is 10 A. Wire lengths must be minimized to reduce losses in the wires. Test-point TP1 provides a place to monitor the V_{IN} input voltages with TP2 providing a convenient ground reference. TP7 is used to monitor the output voltage with TP8 as the ground reference.

Table 2-1. EVM Connectors and Test Points

Reference Designator	Function
J1	VIN input voltage connector. (See Table 1-1 for V_{IN} range).
J2	2-pin header for enable. Connect EN to ground to disable, open to enable.
J3	External VG+ header. To improve converter efficiency, an external 5V supply is recommended to be connected to the VG+ pin (J3-2) to GND (J3-1).
J4	V_{OUT} , 1.2 V at 10 A maximum.
TP1	VIN test point.

Table 2-1. EVM Connectors and Test Points (continued)

Reference Designator	Function
TP2	GND test point at VIN connector.
TP3	PGOOD test point.
TP4	SYNC test point.
TP5	VG+ test point.
TP6	Test point between voltage divider network and output. Used for loop response measurements.
TP7	Output voltage test point.
TP8	GND test point
TP9	Test point at gate of transient load circuit.
TP10	GND test point at input of transient load circuit.
TP11	Test point at top of transient load circuit load resistor
TP12	Test point at bottom (GND) of transient load circuit load resistor
TP13	Analog ground (AGND) test point.

2.2 Efficiency

The efficiency of this EVM peaks at a load current of about 5 A and then decreases as the load current increases toward full load. [Figure 2-1](#) shows the efficiency for the TPS54A20EVM-770 at an ambient temperature of 25°C.

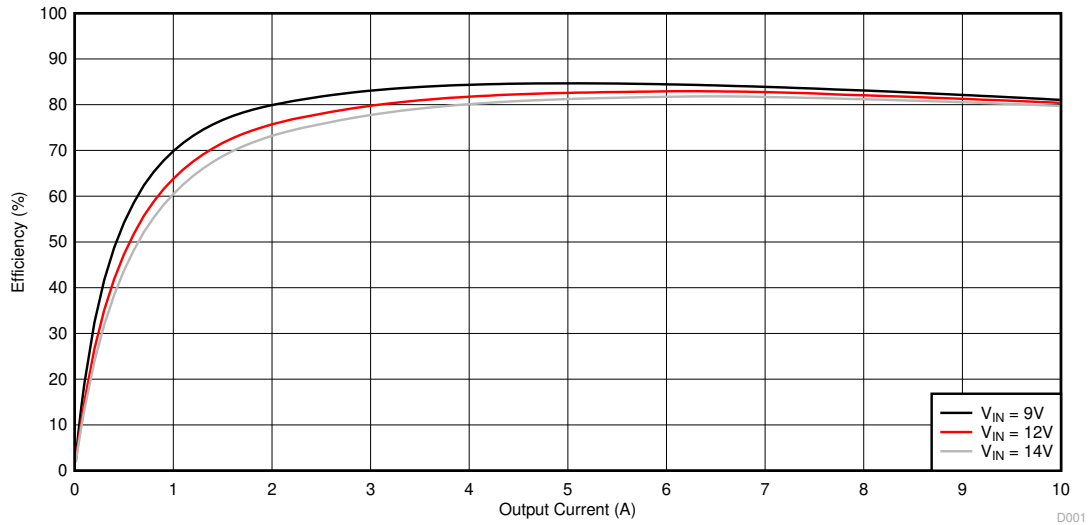

Figure 2-1. TPS54A20EVM-770 Efficiency

[Figure 2-2](#) shows the efficiency for the TPS54A20EVM-770 using a semi-log scale to more easily show efficiency at lower output currents. The ambient temperature is 25°C.

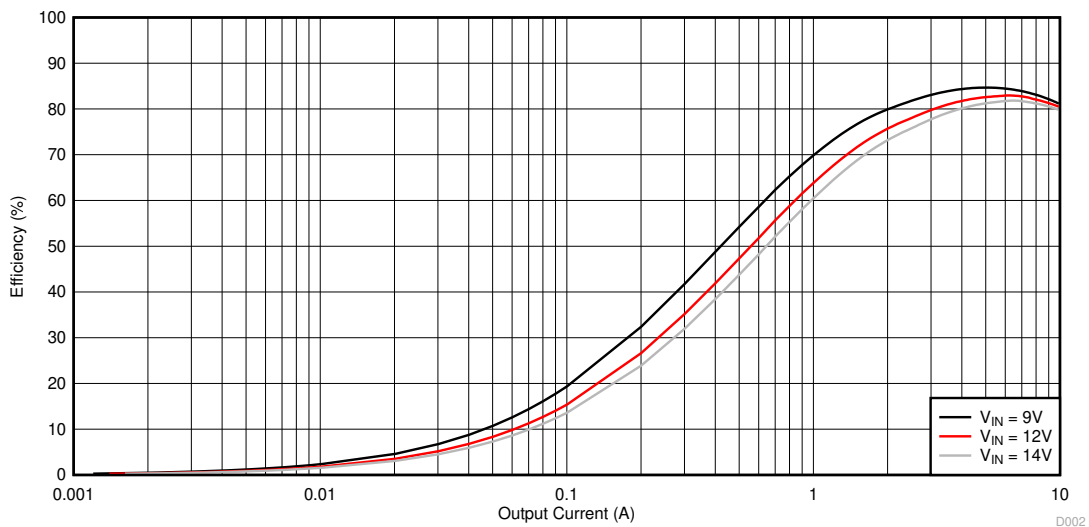

Figure 2-2. TPS54A20EVM-770 Low Current Efficiency

The efficiency may be lower at higher ambient temperatures, due to temperature variation in the drain-to-source resistance of the internal MOSFET.

2.3 Output Voltage Load Regulation

Figure 2-3 shows the load regulation for the TPS54A20EVM-770.

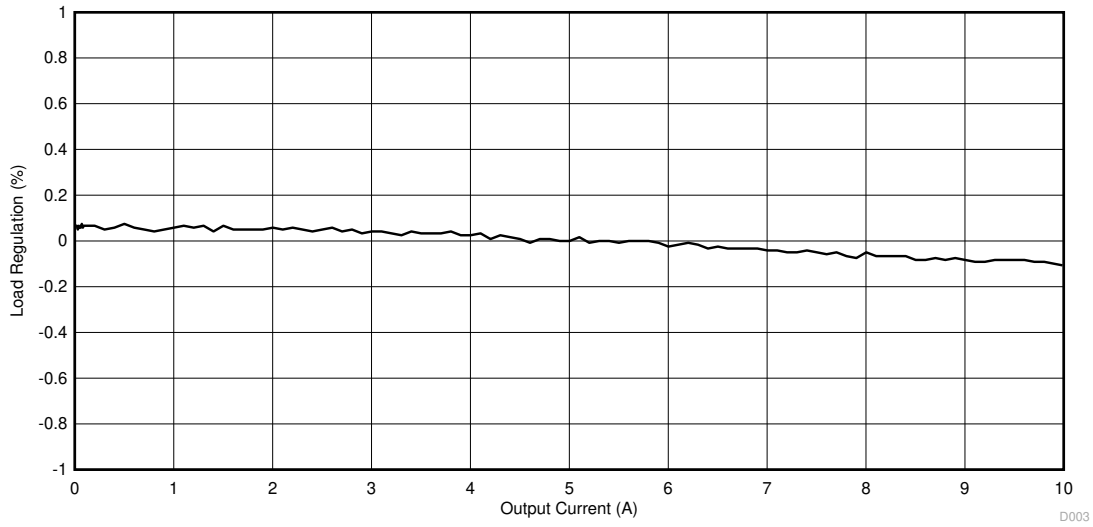

Figure 2-3. TPS54A20EVM-770 Load Regulation

Measurements are given for an ambient temperature of 25°C.

2.4 Output Voltage Line Regulation

Figure 2-4 shows the line regulation for the TPS54A20EVM-770.

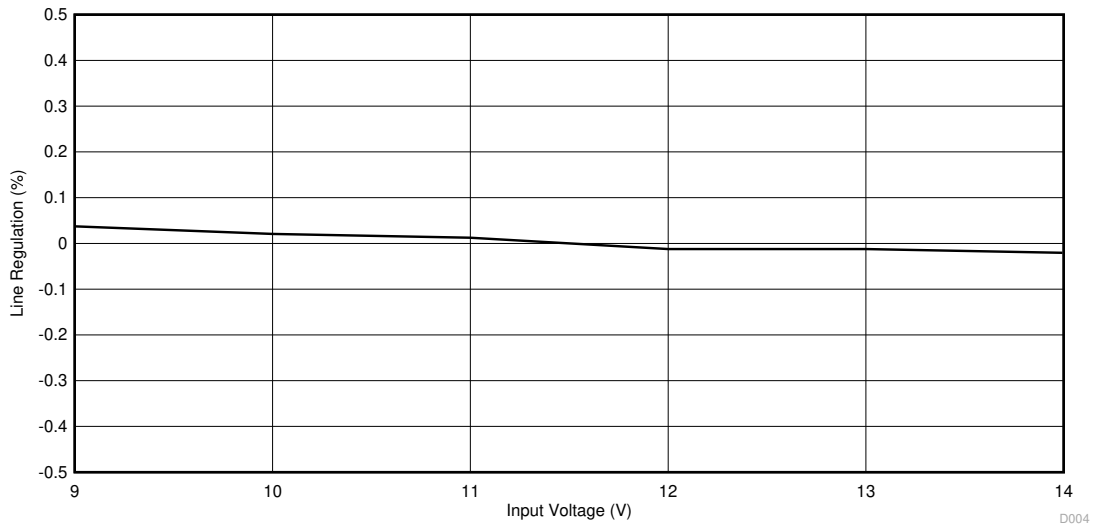

Figure 2-4. TPS54A20EVM-770 Line Regulation

2.5 Load Transients

Figure 2-5 shows the TPS54A20EVM-770 response to load transients. The current step is from 0 A to 9 A. The current step slew rate is 9 A/ μ s. Total peak-to-peak voltage variation is as shown, including ripple and noise on the output. The transient waveform is measured using the on-board fast transient circuit.

CAUTION
Q1 may get hot. Limit the power dissipation to 3W or less. Use low duty cycles.

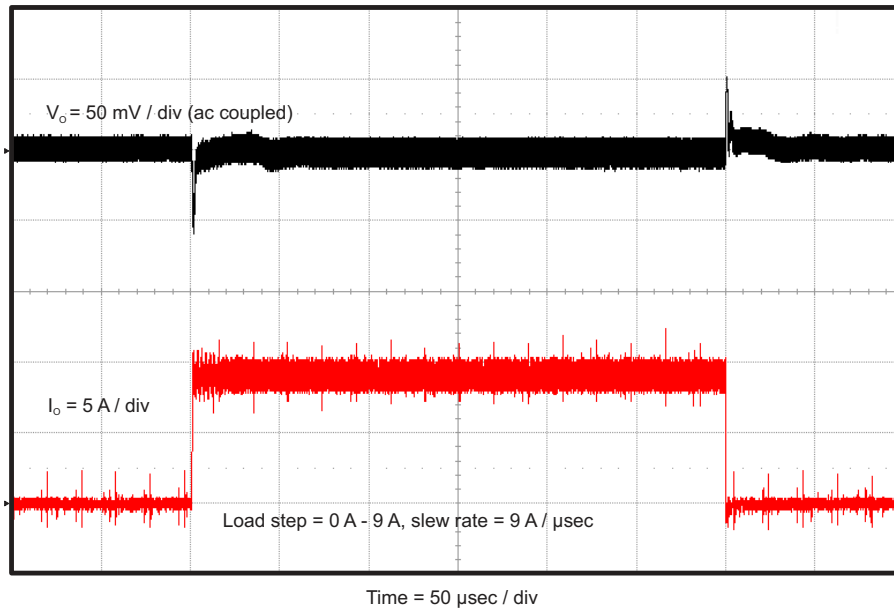

Figure 2-5. TPS54A20EVM-770 Transient Response

2.6 Loop Characteristics

Figure 2-6 shows the TPS54A20EVM-770 loop-response characteristics. Gain and phase plots are shown for V_{IN} voltage of 12 V. Load current for the measurement is 5 A.

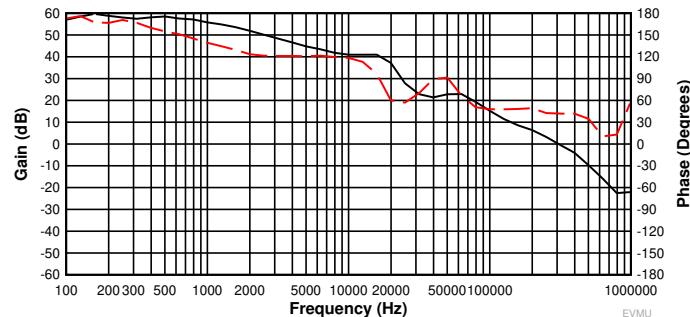

Figure 2-6. TPS54A20EVM-770 Loop Response

2.7 Output Voltage Ripple

Figure 2-7, Figure 2-8, and Figure 2-9 show the TPS54A20EVM-770 output voltage ripple. The load currents are 0 A, 5 A and 10 A. $V_{IN} = 12$ V. The ripple voltage is measured directly across TP7 and TP8.

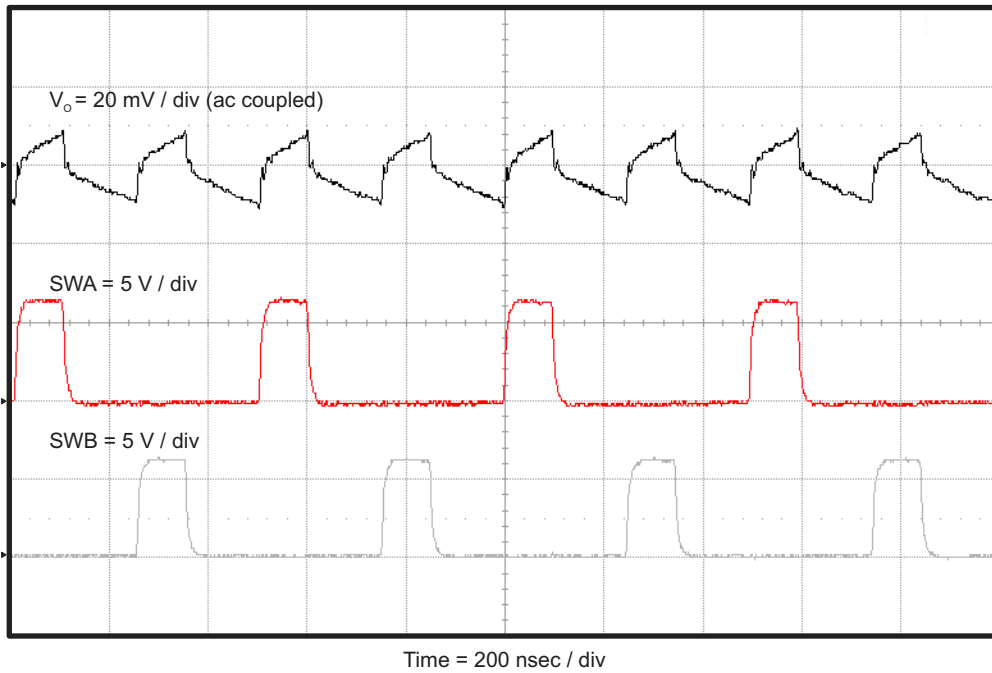

Figure 2-7. TPS54A20EVM-770 Output Ripple, 0 A Load

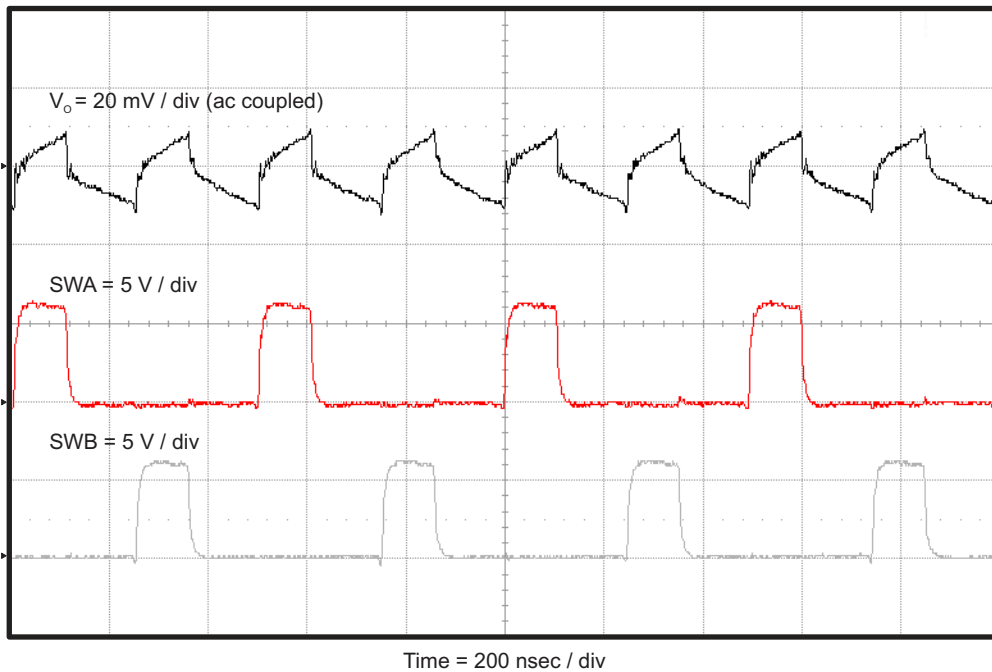

Figure 2-8. TPS54A20EVM-770 Output Ripple, 5 A Load

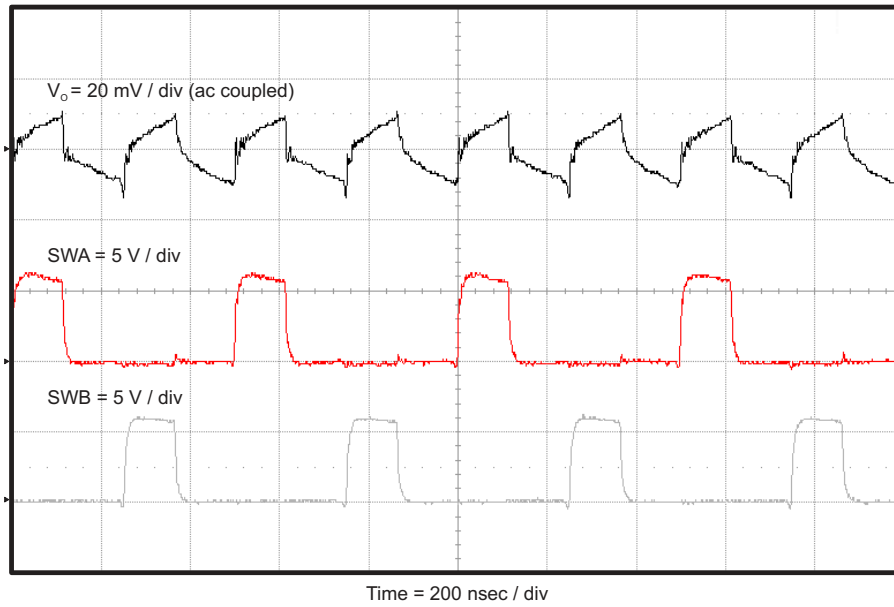

Figure 2-9. TPS54A20EVM-770 Output Ripple, 10 A Load

2.8 Input Voltage Ripple

Figure 2-10, Figure 2-11 and Figure 2-12 show the TPS54A20EVM-770 input voltage ripple. The load currents are 0 A, 5 A and 10 A. $V_{IN} = 12 \text{ V}$. The ripple voltage is measured directly across TP1 and TP2.

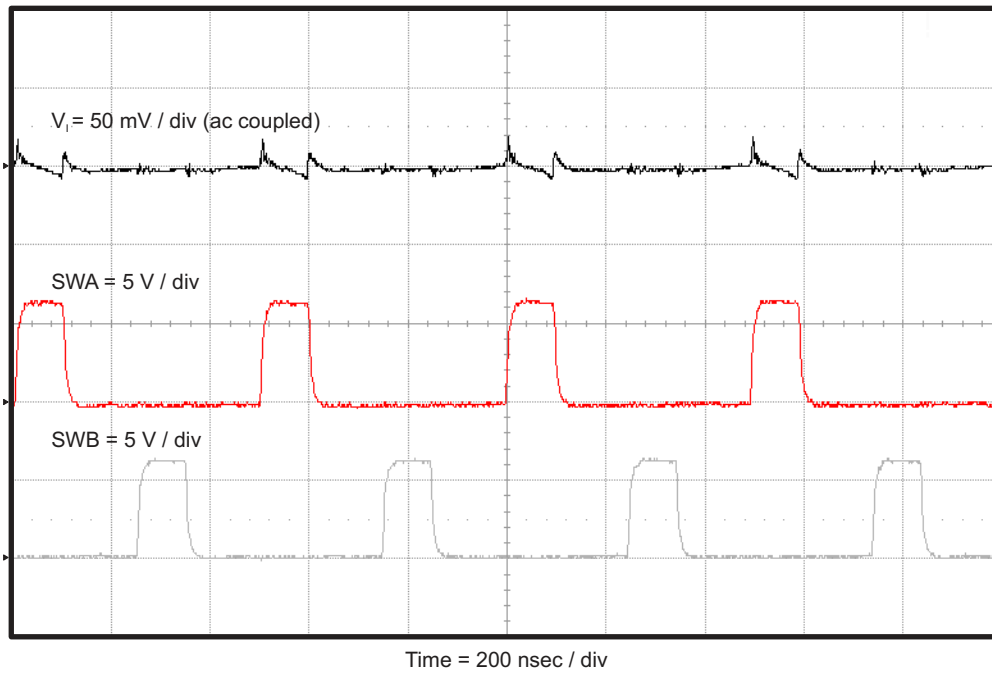

Figure 2-10. TPS54A20EVM-770 Input Ripple, 0 A Load

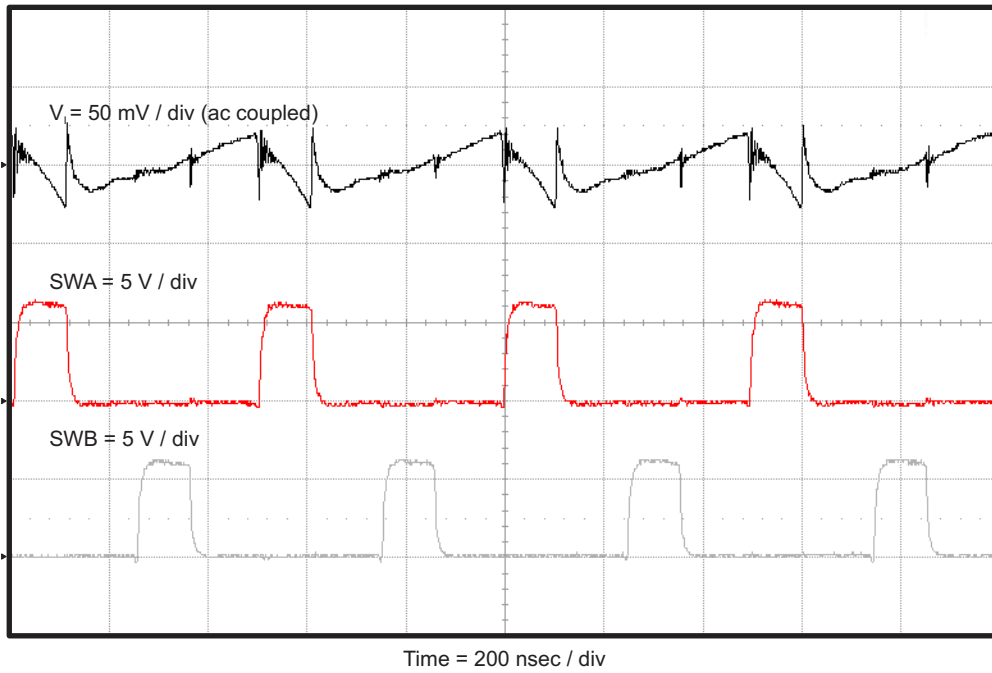

Figure 2-11. TPS54A20EVM-770 Input Ripple, 5 A Load

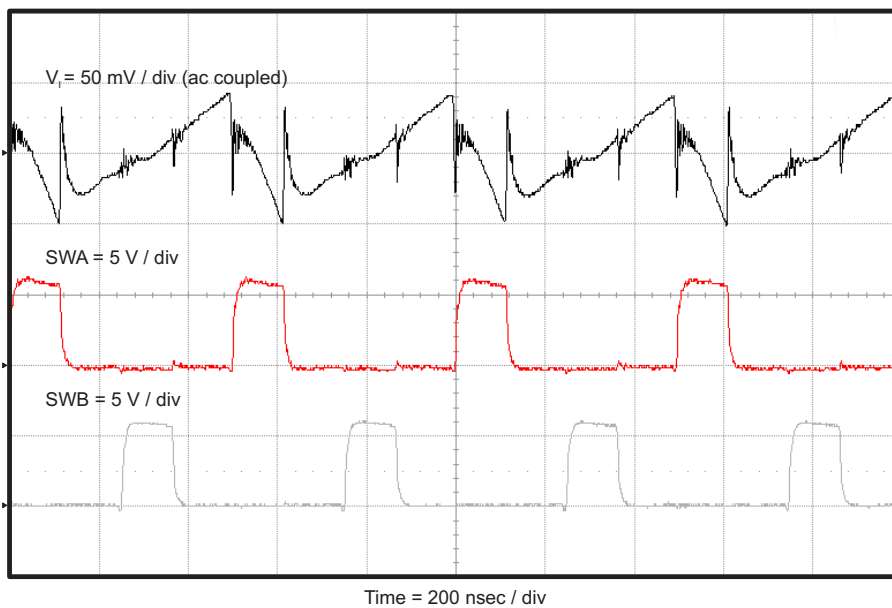

Figure 2-12. TPS54A20EVM-770 Input Ripple, 10 A Load

2.9 Powering Up

Figure 2-13 and Figure 2-14 show the start-up waveforms for the TPS54A20EVM-770. In Figure 2-13, the output voltage ramps up as soon as the input voltage reaches the UVLO threshold as set by the R2 and R3 resistor divider network. In Figure 2-14, the input voltage is initially applied and the output is inhibited by using a jumper at J2 to tie EN to GND. When the jumper is removed, EN is released. When the EN voltage reaches the enable-threshold voltage, the start-up sequence begins and the output voltage ramps up to the externally set value of 1.2 V. The input voltage for these plots is 12 V and the load is 1 Ω .

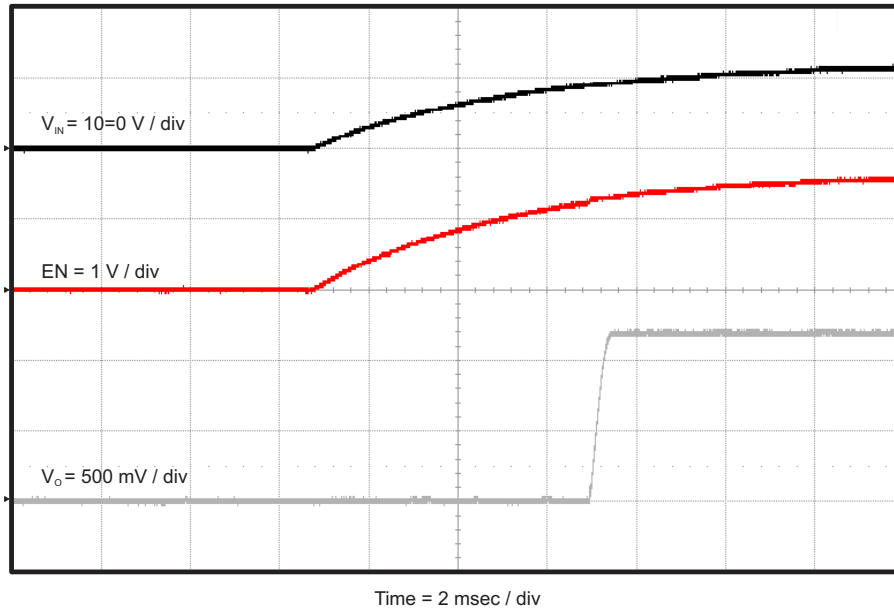

Figure 2-13. TPS54A20EVM-770 Start-Up Relative to V_{IN}

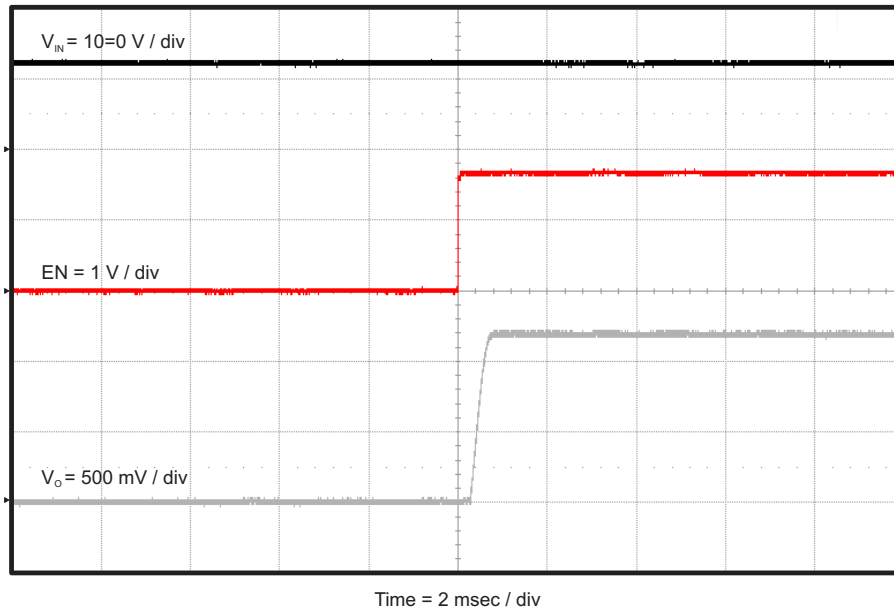
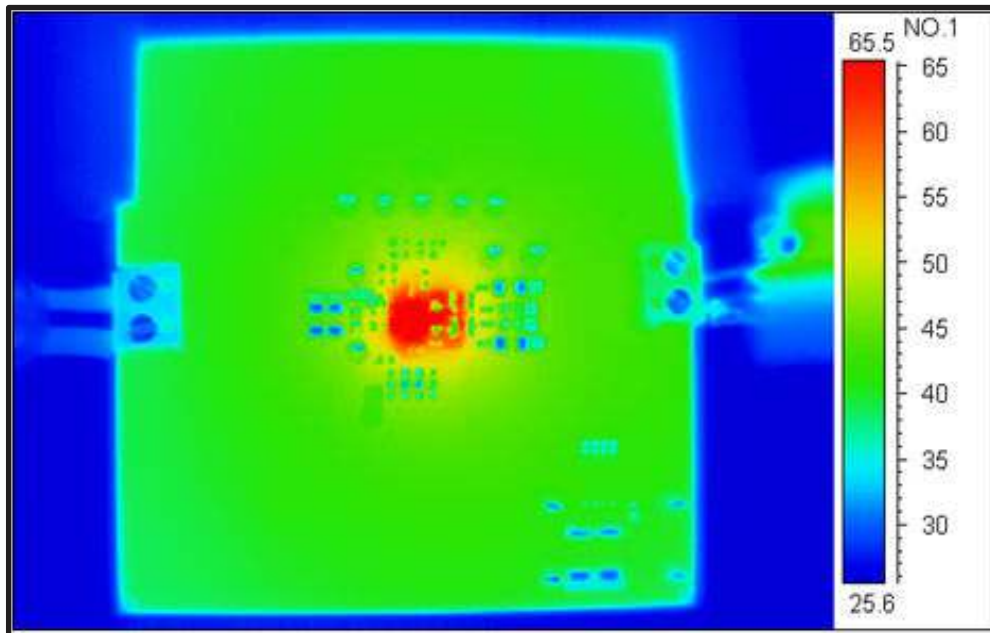

Figure 2-14. TPS54A20EVM-770 Start-Up Relative to Enable

2.10 Thermal Image

The EVM thermal image is shown in [Figure 2-15](#). The input voltage is 12 V and the output current is 10A. The EVM was allowed to operate at full 10 A load for > 45 minutes before the image was captured.



Maximum Case Temperature = 76.3 °C

Figure 2-15. Thermal Image

3 Board Layout

This section provides a description of the TPS54A20EVM-770 board layout and layer illustrations.

3.1 Layout

The board layout for the TPS54A20EVM-770 is shown in [Figure 3-1](#) through [Figure 3-5](#). The top-side layer of the EVM is laid out in a manner typical of a user application. The top, bottom, and internal layers are 2-oz. copper.

The top layer contains the main power traces for V_{IN} , V_{OUT} , SWA and SWB. Also on the top layer are connections for the remaining pins of the TPS54A20 and a large area filled with ground. The internal layer-1 is dedicated ground plane. The internal layer-2 contain an additional large ground copper area as well as an additional V_{OUT} copper fill. The bottom layer is another ground plane with an additional trace for the output voltage feedback. The top-side ground traces are connected to the bottom and internal ground planes with multiple vias placed around the board including five vias directly under the TPS54A20 device to provide a thermal path from the top-side ground plane to the bottom-side ground plane.

The input decoupling capacitors and bootstrap capacitor are all located as close to the IC as possible. Additionally, the voltage setpoint resistor divider components are kept close to the IC. The voltage divider network ties to the output voltage at the point of regulation, the copper V_{OUT} trace at the TP7 test point. For the TPS54A20, an additional input bulk capacitor may be required, depending on the EVM connection to the input supply. Critical analog circuits such as the voltage set point divider, frequency set resistor, and compensation components are terminated to ground using a wide ground trace separate from the power ground pour.

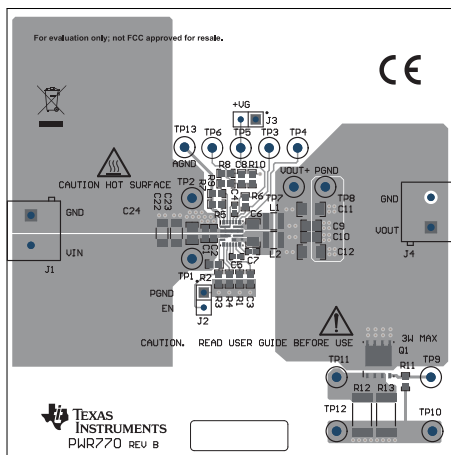

Figure 3-1. TPS54A20EVM-770 Top-Side Assembly

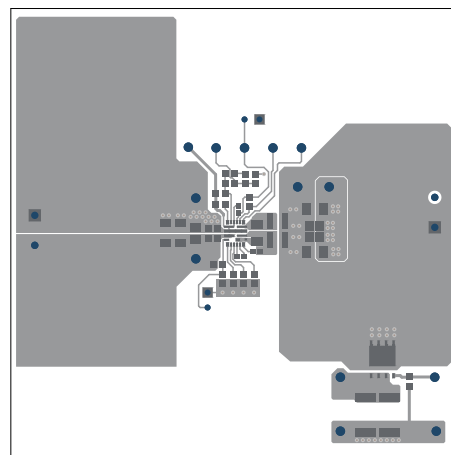

Figure 3-2. TPS54A20EVM-770 Top-Side Layout

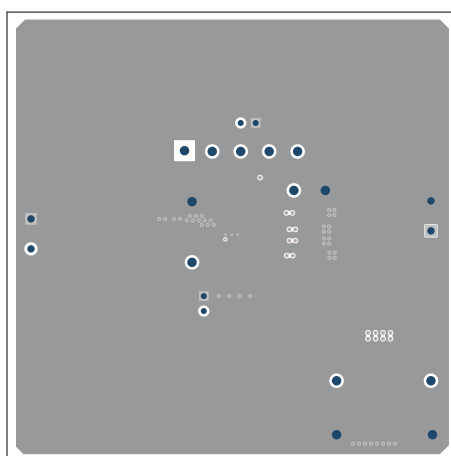

Figure 3-3. TPS54A20EVM-770 Internal Layer-1 Layout

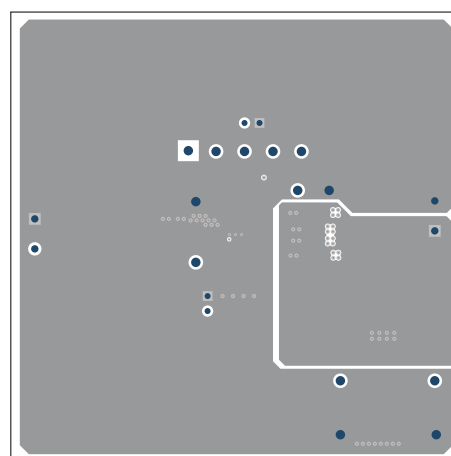

Figure 3-4. TPS54A20EVM-770 Internal Layer-2 Layout

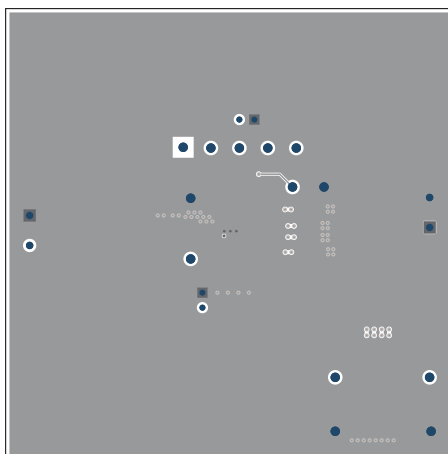

Figure 3-5. TPS54A20EVM-770 Bottom-Side Layout

4 Schematic and Bill of Materials

This section presents the TPS54A20EVM-770 schematic and bill of materials.

4.1 Schematic

Figure 4-1 is the schematic for the TPS54A20EVM-770.

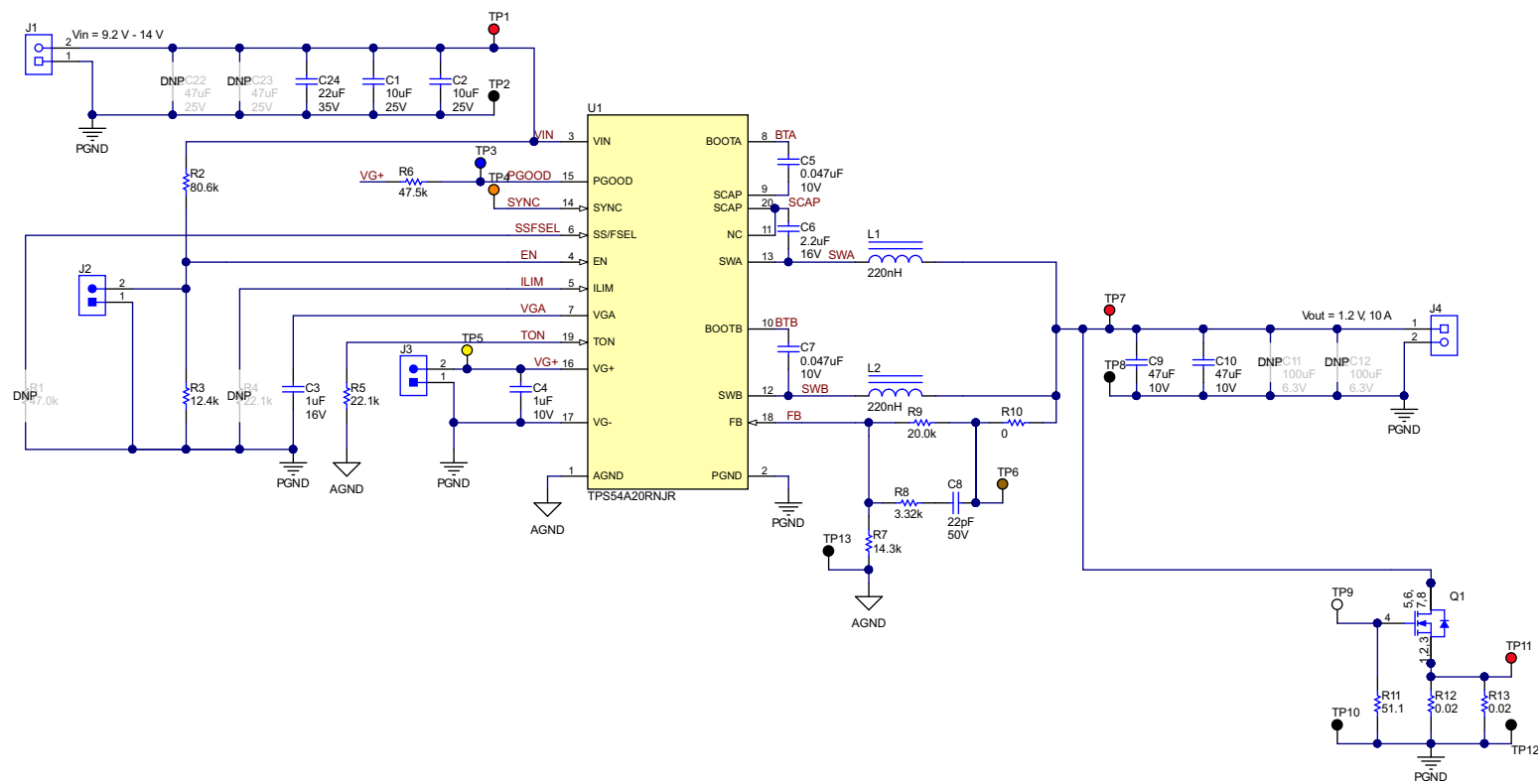

Figure 4-1. TPS54A20EVM-770 Schematic

4.2 Bill of Materials

Table 4-1 presents the bill of materials for the TPS54A20EVM-770.

Table 4-1. TPS54A20EVM-770 Bill of Materials

Designator	Quantity	Value	Description	Package	Part Number	Manufacturer
PCB	1		Printed Circuit Board		PWR770	Any
C1, C2	2	10uF	CAP, CERM, 10 uF, 25 V, +/- 20%, X5R, 0603	0603	C1608X5R1E106M080AC	TDK
C3	1	1uF	CAP, CERM, 1 uF, 16 V, +/- 10%, X7R, 0603	0603	C1608X7R1C105K080AC	TDK
C4	1	1uF	CAP, CERM, 1 uF, 10 V, +/- 10%, X5R, 0402	0402	GRM155R61A105KE15D	MuRata
C5, C7	2	0.047uF	CAP, CERM, 0.047 uF, 10 V, +/- 10%, X5R, 0402	0402	C1005X5R1A473K050BA	TDK
C6	1	2.2uF	CAP, CERM, 2.2 uF, 16 V, +/- 10%, X7R, 1206	1206	GRM31MR71C225KA35L	MuRata

Table 4-1. TPS54A20EVM-770 Bill of Materials (continued)

Designator	Quantity	Value	Description	Package	Part Number	Manufacturer
C8	1	22pF	CAP, CERM, 22 pF, 50 V, +/- 5%, C0G/NP0, 0603	0603	06035A220JAT2A	AVX
C9, C10	2	47uF	CAP, CERM, 47 uF, 10 V, +/- 20%, X5R, 0805	0805	GRM21BR61A476ME15	MuRata
C24	1	22uF	CAP, CERM, 22 uF, 35 V, +/- 20%, X5R, 0805	0805	C2012X5R1V226M125AC	TDK
J1, J4	2		Terminal Block, 5.08 mm, 2x1, Brass, TH	2x1 5.08 mm Terminal Block	ED120/2DS	On-Shore Technology
J2, J3	2		Header, 100mil, 2x1, Gold, TH	Header, 100mil, 2x1, TH	HTSW-102-07-G-S	Samtec
L1, L2	2	220nH	Inductor, 220 nH, 7.2 A, 0.0075 ohm, SMD	3.2x2.5mm	MLA-FY12NR22N-M3-RU	Mag Layers
Q1	1	30V	MOSFET, N-CH, 30 V, 65 A, DQJ0008A (VSONP-8)	DQJ0008A	CSD17527Q5A	Texas Instruments
R2	1	80.6k	RES, 80.6 k, 1%, 0.1 W, 0603	0603	CRCW060380K6FKEA	Vishay-Dale
R3	1	12.4k	RES, 12.4 k, 1%, 0.1 W, 0603	0603	CRCW060312K4FKEA	Vishay-Dale
R5	1	22.1k	RES, 22.1 k, 1%, 0.1 W, 0603	0603	RC0603FR-0722K1L	Yageo America
R6	1	47.5k	RES, 47.5 k, 1%, 0.1 W, 0603	0603	RC0603FR-0747K5L	Yageo America
R7	1	14.3k	RES, 14.3 k, 1%, 0.1 W, 0603	0603	CRCW060314K3FKEA	Vishay-Dale
R8	1	3.32k	RES, 3.32 k, 1%, 0.1 W, 0603	0603	CRCW06033K32FKEA	Vishay-Dale
R9	1	20.0k	RES, 20.0 k, 1%, 0.1 W, 0603	0603	CRCW060320K0FKEA	Vishay-Dale
R10	1	0	RES, 0, 5%, 0.1 W, 0603	0603	ERJ-3GEY0R00V	Panasonic
R11	1	51.1	RES, 51.1, 0.1%, 0.1 W, 0603	0603	RT0603BRD0751R1L	Yageo America
R12, R13	2	0.02	RES, 0.02, 1%, 3 W, 2512	2512	CRA2512-FZ-R020ELF	Bourns
SH-J1	1	1x2	Shunt, 100mil, Gold plated, Black	Shunt	SNT-100-BK-G	Samtec
TP1, TP7, TP11	3		Test Point, Multipurpose, Red, TH	Red Multipurpose Testpoint	5010	Keystone
TP2, TP8, TP10, TP12, TP13	5		Test Point, Multipurpose, Black, TH	Black Multipurpose Testpoint	5011	Keystone
TP3	1		Test Point, Multipurpose, Blue, TH	Blue Multipurpose Testpoint	5127	Keystone
TP4	1		Test Point, Multipurpose, Orange, TH	Orange Multipurpose Testpoint	5013	Keystone
TP5	1		Test Point, Multipurpose, Yellow, TH	Yellow Multipurpose Testpoint	5014	Keystone
TP6	1		Test Point, Multipurpose, Brown, TH	Brown Multipurpose Testpoint	5125	Keystone
TP9	1		Test Point, Multipurpose, White, TH	White Multipurpose Testpoint	5012	Keystone
U1	1		Small, 10MHz 10A, 8V to 14V Input, SWIFT Series Capacitor Step-Down Converter, RNJ0020A (VQFN-HR-20)	RNJ0020A	TPS54A20RNJR	Texas Instruments
C11, C12	0	100uF	CAP, CERM, 100 uF, 6.3 V, +/- 20%, X5R, 1206	1206	JMK316BJ107ML-T	Taiyo Yuden
C22, C23	0	47uF	CAP, CERM, 47 uF, 25 V, +/- 20%, X5R, 1206_190	1206_190	C3216X5R1E476M160AC	TDK
R1	0	47.0k	RES, 47.0 k, 1%, 0.1 W, 0603	0603	RC0603FR-0747KL	Yageo America
R4	0	22.1k	RES, 22.1 k, 1%, 0.1 W, 0603	0603	RC0603FR-0722K1L	Yageo America

5 Revision History

NOTE: Page numbers for previous revisions may differ from page numbers in the current version.

Changes from Revision A (March 2019) to Revision B (August 2021) Page

- Updated user's guide title..... 2
- Updated the numbering format for tables, figures, and cross-references throughout the document.2

Changes from Revision * (December 2015) to Revision A (March 2019) Page

- Changed 1 k Ω to 14.3 k Ω 3
 - Updated [Figure 2-6](#) 8
 - Updated [Figure 3-1](#) through [Figure 3-5](#)..... 14
 - Updated [Figure 4-1](#)..... 15
 - Updated [Table 4-1](#)..... 16
-

IMPORTANT NOTICE AND DISCLAIMER

TI PROVIDES TECHNICAL AND RELIABILITY DATA (INCLUDING DATA SHEETS), DESIGN RESOURCES (INCLUDING REFERENCE DESIGNS), APPLICATION OR OTHER DESIGN ADVICE, WEB TOOLS, SAFETY INFORMATION, AND OTHER RESOURCES "AS IS" AND WITH ALL FAULTS, AND DISCLAIMS ALL WARRANTIES, EXPRESS AND IMPLIED, INCLUDING WITHOUT LIMITATION ANY IMPLIED WARRANTIES OF MERCHANTABILITY, FITNESS FOR A PARTICULAR PURPOSE OR NON-INFRINGEMENT OF THIRD PARTY INTELLECTUAL PROPERTY RIGHTS.

These resources are intended for skilled developers designing with TI products. You are solely responsible for (1) selecting the appropriate TI products for your application, (2) designing, validating and testing your application, and (3) ensuring your application meets applicable standards, and any other safety, security, regulatory or other requirements.

These resources are subject to change without notice. TI grants you permission to use these resources only for development of an application that uses the TI products described in the resource. Other reproduction and display of these resources is prohibited. No license is granted to any other TI intellectual property right or to any third party intellectual property right. TI disclaims responsibility for, and you will fully indemnify TI and its representatives against, any claims, damages, costs, losses, and liabilities arising out of your use of these resources.

TI's products are provided subject to [TI's Terms of Sale](#) or other applicable terms available either on ti.com or provided in conjunction with such TI products. TI's provision of these resources does not expand or otherwise alter TI's applicable warranties or warranty disclaimers for TI products.

TI objects to and rejects any additional or different terms you may have proposed.

Mailing Address: Texas Instruments, Post Office Box 655303, Dallas, Texas 75265
Copyright © 2022, Texas Instruments Incorporated