

Type MRS Series

Key Features

Advanced Thin Film Technology

Tight Tolerance

Low TCR

Tight tolerance matching and TCR tracking

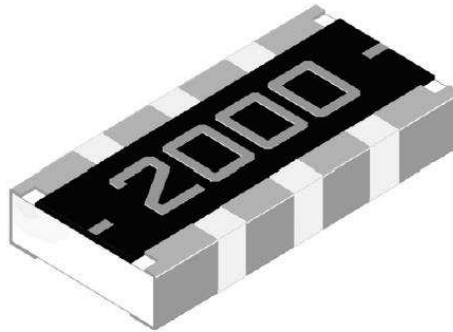

**PRODUCT
PLANNED
FOR EOL**

**LTB
18/08/2023**

The MRS series is a chip network utilising nickel chrome sputtering on high purity alumina. This network has been designed for high volume applications and is offered with 4 isolated resistors on a single substrate (4 x 0603 resistors) at 0.1% now with flat terminals. A wide value range and alternative TCRs (Temperature Coefficient of Resistance) make this a most versatile resistor solution.

Characteristics – Electrical

Item	Standard Power		High Power	
Power Rating (W) @ 70°C	0.0625		0.1	
Resistance Range (Ω)	24R9 ~ 60K	24R9 ~ 332K	24R9 ~ 60K	24R9 ~ 332K
Tolerance %	±0.1, ±0.25, ±0.5, ±1		±0.1, ±0.25, ±0.5, ±1	
TCR PPM/°C	±5	±10, ±15, ±25, ±50	±5	±10, ±15, ±25, ±50
Max. Operating Voltage (V)	50		75	
Max. Overload Voltage (V)	100		150	
Operating Temperature	-55 ~ +155°C			

Operating Voltage= $V(P \cdot R)$ or max. operating voltage listed above, whichever is lower
 Overload Voltage= $2.5 \cdot V(P \cdot R)$ or max. overload voltage listed above, whichever is lower

Derating

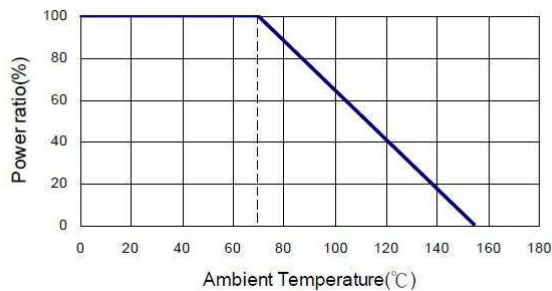

Environmental Characteristics

Item	Requirement	Test Methods
Temperature Coefficient of Resistance (TCR)	As Spec	MIL-STD-202 Method 304 +25/-55/+25/-125/+25°C
Short Time Overload	$\Delta R \pm 0.1$	JIS-C-5201-1 4.13 RCWV*2.5 or Max. Overload Voltage, whichever is lower, for 5 seconds
Insulation Resistance	>1000M Ω	MIL-STD-102 Method 302 Apply 100Vdc for 1 minute
Endurance	1000Hr: $\Delta R \pm 0.15\%$ 8000Hr: $\Delta R \pm 0.3\%$	MIL-STD-202 Method 108A 70 $\pm 2^\circ\text{C}$ RCWV with 1.5 Hrs "ON" and 0.5 Hrs "OFF"
Damp Heat With Load	$\Delta R \pm 0.25\%$	MIL-STD-202 Method 103B 40 $\pm 2^\circ\text{C}$, 90-95% RH, RCWV for 1000 Hrs with 1.5 Hrs "ON" and 0.5 Hrs "OFF"
Damp Heat With Load (85°C/85% RH)	$\Delta R \pm 0.5\%$	85 $\pm 2^\circ\text{C}$, 80 – 90% RH. 10% of RCWV for 1000Hrs with 1.5 Hrs "ON" and 0.5 Hrs "OFF"
Dry Heat	1000Hr: $\Delta R \pm 0.25\%$ 8000Hr: $\Delta R \pm 0.5\%$	At +125°C
Bending Strength	$\Delta R \pm 0.2\%$	JIS-C-5201-1 4.33 Bending amplitude 3mm for 10 seconds
Solderability	95% min. coverage	MIL-STD-202 Method 208H 245 $\pm 5^\circ\text{C}$ for 3 seconds
Resistance to Soldering Heat	$\Delta R \pm 0.2\%$	MIL-STD-202 Method 210E 260 $\pm 5^\circ\text{C}$ for 10 seconds
Dielectric Withstand Voltage	100V	MIL-STD-202 Method 301 Max Overload Voltage for 1 minute
Thermal Shock	$\Delta R \pm 0.25\%$	MIL-STD-202 Method 107G -55°C~150°C, 100 cycles
Low Temperature Operation	$\Delta R \pm 0.25\%$	JIS-C-5201-1 4.36 1 hour, -65°C followed by 45 minutes of RCWV

Operating Voltage= $V(P \cdot R)$ or max. operating voltage, whichever is lower

Storage Temperature 15 ~ 28°C; Humidity <80%RH

Construction

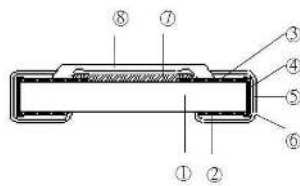

① Alumina Substrate	④ Edge Electrode	⑦ Resistor Layer
② Bottom Electrode	③ Barrier Layer	⑧ Overcoat
③ Top Electrode	⑥ External Electrode	

Equivalent Circuit Diagram

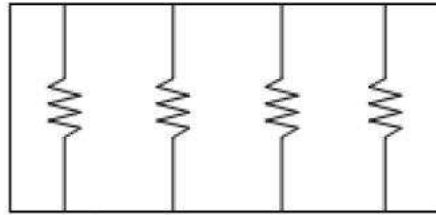

Dimensions

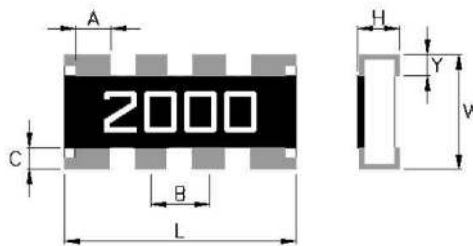

$L \pm 0.15$	$W \pm 0.15$	$H \pm 0.10$	$A \pm 0.15$	$B \pm 0.05$	$C \pm 0.15$	$Y \pm 0.15$
3.20	1.60	0.55	0.50	0.80	0.30	0.30

Recommended PCB Plan

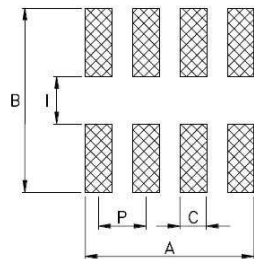

Unit: mm

Type	A	B	C	I	P
MRS	3.10	2.85	0.45	0.80	0.80

Reflow Solder Profile

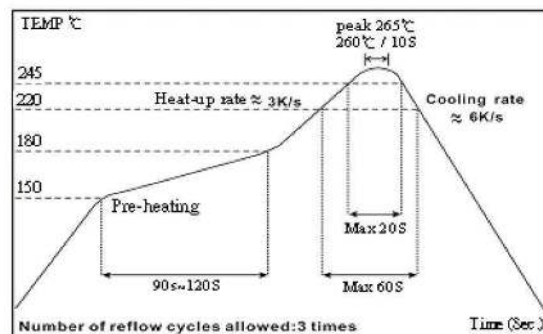

Packaging

Reel Specification

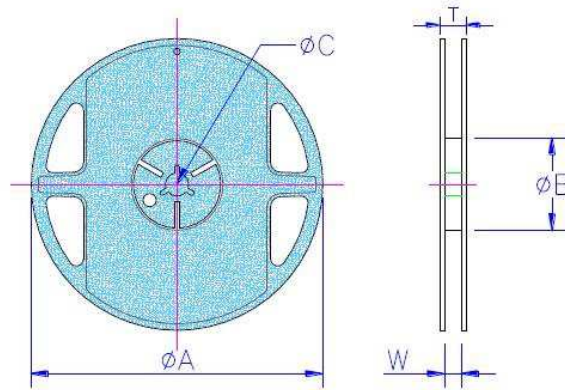

Pack / Quantity	Tape Width	Reel Diameter	ØA	ØB	ØC	W ±0.5	T ±0.5
Paper 5K	8mm	7 inch	178.5	60	13.0	9.0	12.5

Paper Tape Specification

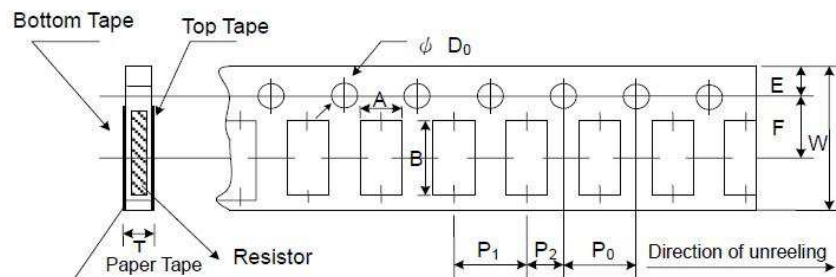

A ±0.1	B ±0.1	W ±0.2	E ±0.1	F ±0.05	P ₀ ±0.1	P ₁ ±0.05	P ₂ ±0.05	ØD ₀ +0.1/-0	T ±0.1
1.95	3.50	8.0	1.75	3.5	4.0	4.0	2.0	1.5	0.85

Marking

4 Digit Marking – 3 significant figures plus number of following zeros.

Example:

Resistance	100Ω	2.2KΩ	10KΩ	49.9KΩ	100KΩ	332KΩ
Marking	1000	2201	1002	4992	1003	3323

Tolerance Matching and TCR Tracking

Accuracy Grade Table						
Tolerance Grade			TCR Grade			
Code	Absolute Tolerance	Tolerance Matching	Code	Absolute TCR	TCR Tracking	Resistance Value
B0	±0.1%	N/A	A0	±5ppm	N/A	24R9 ~ 60K
B3	±0.1%	0.1%	A5	±5ppm	±5ppm	24R9 ~ 60K
C0	±0.25%	N/A	C0	±10ppm	N/A	24R9 ~ 332K
C2	±0.25%	0.25%	C4	±10ppm	±10ppm	24R9 ~ 332K
C3	±0.25%	1%	C5	±10ppm	±5ppm	24R9 ~ 60K
D0	±0.5%	N/A	D0	±15ppm	N/A	24.9 ~ 332K
D1	±0.5%	0.5%	D3	±15ppm	15ppm	24.9 ~ 332K
D2	±0.5%	0.25%	D4	±15ppm	10ppm	24.9 ~ 332K
F0	±1%	N/A	D5	±15ppm	5ppm	24.9~60K
F1	±1%	0.5%	F0	±25ppm	N/A	24.9~332K
F2	±1%	0.25%	F2	±25ppm	25ppm	24.9~332K
			F3	±25ppm	15ppm	24.9K~332K
			F4	±25ppm	10ppm	24.9K~332K
			G0	±50ppm	N/A	24.9~332K
			G1	±50ppm	50ppm	24.9K~332K
			G2	±50ppm	25ppm	24.9K~332K

How To Order

MRS	10K	B	F		
Common Part	Resistance Value	Absolute Tolerance	Absolute TCR	Tolerance Matching	TCR Tracking
MRS – Standard Power	100R (100Ω)	B - ±0.1%	A - ±5ppm	As Chart above.	As Chart above.
MRSP – High Power	1K0 (1000Ω)	C - ±0.25%	C - ±10ppm	For N/A leave Blank	For N/A leave Blank
	10K (10,000Ω)	D - ±0.5%	D - ±15ppm		
	100K (100,000Ω)	F - ±1%	F - ±25ppm		
			G - ±50ppm		