

# LED Drivers for High Power LEDs

## ILD4035

350 mA Step Down LED Driver

### Data Sheet

Revision 2.0, 2011-08-17

Industrial and Multimarket

**Edition 2011-08-17**

**Published by  
Infineon Technologies AG  
81726 Munich, Germany**

**© 2011 Infineon Technologies AG  
All Rights Reserved.**

### **Legal Disclaimer**

The information given in this document shall in no event be regarded as a guarantee of conditions or characteristics. With respect to any examples or hints given herein, any typical values stated herein and/or any information regarding the application of the device, Infineon Technologies hereby disclaims any and all warranties and liabilities of any kind, including without limitation, warranties of non-infringement of intellectual property rights of any third party.

### **Information**

For further information on technology, delivery terms and conditions and prices, please contact the nearest Infineon Technologies Office ([www.infineon.com](http://www.infineon.com)).

### **Warnings**

Due to technical requirements, components may contain dangerous substances. For information on the types in question, please contact the nearest Infineon Technologies Office.

Infineon Technologies components may be used in life-support devices or systems only with the express written approval of Infineon Technologies, if a failure of such components can reasonably be expected to cause the failure of that life-support device or system or to affect the safety or effectiveness of that device or system. Life support devices or systems are intended to be implanted in the human body or to support and/or maintain and sustain and/or protect human life. If they fail, it is reasonable to assume that the health of the user or other persons may be endangered.

### Revision History

Page or Item	Subjects (major changes since previous revision)
<b>Revision 2.0, 2011-08-17</b>	
<b>Table 2</b>	Maximum peak current specified for hysteretic peak condition
<b>Table 2</b>	Maximum junction temperature increased to 150 °C
<b>Figure 3</b>	Safe operating area increased
<b>Table 4</b>	Maximum supply voltage reduced to 40 V
<b>Table 4</b>	Overall current consumption and standby current reduced
<b>Table 4</b>	Over temperature protection improved from flicker to sloped behaviour
<b>Table 5</b>	Application setup changed
<b>Table 6</b>	Voltage range of digital control signals changed
<b>Chapter 6.3</b>	Over temperature protection improved from flicker to sloped behaviour
<b>Chapter 6.4</b>	Figures of switching parameters changed
<b>Revision 1.0, 2010-11-11</b>	

### Trademarks of Infineon Technologies AG

AURIX™, BlueMoon™, C166™, CanPAK™, CIPOS™, CIPURSE™, COMNEON™, EconoPACK™, CoolMOS™, CoolSET™, CORECONTROL™, CROSSAVE™, DAVE™, EasyPIM™, EconoBRIDGE™, EconoDUAL™, EconoPIM™, EiceDRIVER™, eupec™, FCOS™, HITFET™, HybridPACK™, I<sup>2</sup>RF™, ISOFACE™, IsoPACK™, MIPAQ™, ModSTACK™, my-d™, NovalithIC™, OmniTune™, OptiMOS™, ORIGA™, PRIMARION™, PrimePACK™, PrimeSTACK™, PRO-SIL™, PROFET™, RASIC™, ReverSave™, SatRIC™, SIEGET™, SINDRION™, SIPMOS™, SMARTi™, SmartLEWIS™, SOLID FLASH™, TEMPFET™, thinQ!™, TRENCHSTOP™, TriCore™, X-GOLD™, X-PMU™, XMM™, XPOSYS™.

### Other Trademarks

Advance Design System™ (ADS) of Agilent Technologies, AMBA™, ARM™, MULTI-ICE™, KEIL™, PRIMECELL™, REALVIEW™, THUMB™, µVision™ of ARM Limited, UK. AUTOSAR™ is licensed by AUTOSAR development partnership. Bluetooth™ of Bluetooth SIG Inc. CAT-iq™ of DECT Forum. COLOSSUS™, FirstGPS™ of Trimble Navigation Ltd. EMV™ of EMVCo, LLC (Visa Holdings Inc.). EPCOS™ of Epcos AG. FLEXGO™ of Microsoft Corporation. FlexRay™ is licensed by FlexRay Consortium. HYPERTERMINAL™ of Hilgraeve Incorporated. IEC™ of Commission Electrotechnique Internationale. IrDA™ of Infrared Data Association Corporation. ISO™ of INTERNATIONAL ORGANIZATION FOR STANDARDIZATION. MATLAB™ of MathWorks, Inc. MAXIM™ of Maxim Integrated Products, Inc. MICROTEC™, NUCLEUS™ of Mentor Graphics Corporation. Mifare™ of NXP. MIPI™ of MIPI Alliance, Inc. MIPS™ of MIPS Technologies, Inc., USA. muRata™ of MURATA MANUFACTURING CO., MICROWAVE OFFICE™ (MWO) of Applied Wave Research Inc., OmniVision™ of OmniVision Technologies, Inc. Openwave™ Openwave Systems Inc. RED HAT™ Red Hat, Inc. RFMD™ RF Micro Devices, Inc. SIRIUS™ of Sirius Satellite Radio Inc. SOLARIS™ of Sun Microsystems, Inc. SPANSION™ of Spansion LLC Ltd. Symbian™ of Symbian Software Limited. TAIYO YUDEN™ of Taiyo Yuden Co. TEAKLITE™ of CEVA, Inc. TEKTRONIX™ of Tektronix Inc. TOKO™ of TOKO KABUSHIKI KAISHA TA. UNIX™ of X/Open Company Limited. VERILOG™, PALLADIUM™ of Cadence Design Systems, Inc. VLYNQ™ of Texas Instruments Incorporated. VXWORKS™, WIND RIVER™ of WIND RIVER SYSTEMS, INC. ZETEX™ of Diodes Zetex Limited.

Last Trademarks Update 2010-10-26

## Table of Contents

	<b>Table of Contents</b> .....	4
	<b>List of Figures</b> .....	5
	<b>List of Tables</b> .....	6
<b>1</b>	<b>Features</b> .....	8
<b>2</b>	<b>Product Brief</b> .....	9
<b>3</b>	<b>Maximum Ratings</b> .....	11
<b>4</b>	<b>Thermal Characteristics</b> .....	12
<b>5</b>	<b>Electrical Characteristics</b> .....	14
5.1	DC Characteristics .....	14
5.2	Switching Characteristics .....	15
5.3	Digital Signals .....	15
<b>6</b>	<b>Basic Application Information</b> .....	16
6.1	Setting the average LED current .....	16
6.2	Dimming of the LEDs .....	16
6.3	Temperature Protection Circuit .....	19
6.4	Switching Parameters .....	19
<b>7</b>	<b>Application Circuit</b> .....	28
<b>8</b>	<b>Evaluation Board</b> .....	28
<b>9</b>	<b>Package Information</b> .....	29

## List of Figures

Figure 1	Block Diagram	9
Figure 2	Total Power Dissipation	12
Figure 3	Safe Operating Area	13
Figure 4	PWM Dimming	18
Figure 5	Application Circuit	28
Figure 6	ILD4035 on Evaluation Board	28
Figure 7	Package Outline SC74	29
Figure 8	Recommended PCB Footprint for Reflow Soldering	29
Figure 9	Tape Loading	29

## List of Tables

Table 1	Pin Definition and Function .....	10
Table 2	Maximum Ratings .....	11
Table 3	Maximum Thermal Resistance .....	12
Table 4	DC Characteristics .....	14
Table 5	Switching Characteristics .....	15
Table 6	Digital Control Parameter at Pin EN/PWM .....	15



## 350 mA Step Down LED Driver with Internal Switch ILD4035

### 1 Features

- Wide input voltage range: 4.5 V ... 40 V
- Internal switch for up to 400 mA average LED current
- Up to 95 % efficiency
- Over current protection
- Over voltage protection
- Temperature protection mechanism
- Inherent open-circuit LED protection
- Soft-start capability
- Low shut down current
- Analog and PWM dimming possible
- Typical 3 % output current accuracy
- Minimum external components required
- Small package: SC74

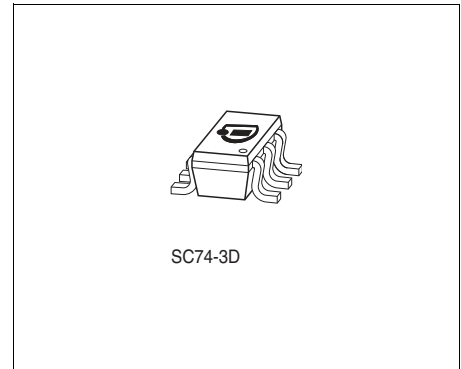

### Applications

- LED driver for general lighting applications
- Retail, office and residential luminaires and downlights
- LED replacement lamps
- Architectural lighting

Product Name	Package	Pin Configuration						Marking
ILD4035	SC74-6-4	1 = $V_S$	2 = GND	3 = EN	4 = $V_{switch}$	5 = GND	6 = $V_{sense}$	35



## 2 Product Brief

The ILD4035 is a hysteretic step down LED driver IC for general lighting applications, which is capable to drive high power LEDs with average currents up to 400 mA.

The IC incorporates a wide input voltage range and an internal power switch. The output current level can be adjusted with an external sense resistor.

According to the multifunctional control pin the IC can be switched on and off by an external signal, which is also suitable to regulate brightness of the LEDs by PWM or analog voltage dimming.

Depending on the value of the switching inductor the switching frequency and the voltage ripple can be set.

The precise internal bandgap stabilizes the circuit and provides stable current conditions over temperature range.

To ensure a long lifetime of the LED system, the ILD4035 incorporates an overvoltage and an overcurrent protection.

In addition, the integrated thermal protection will reduce the output current to protect the LEDs and the IC against thermal stress.

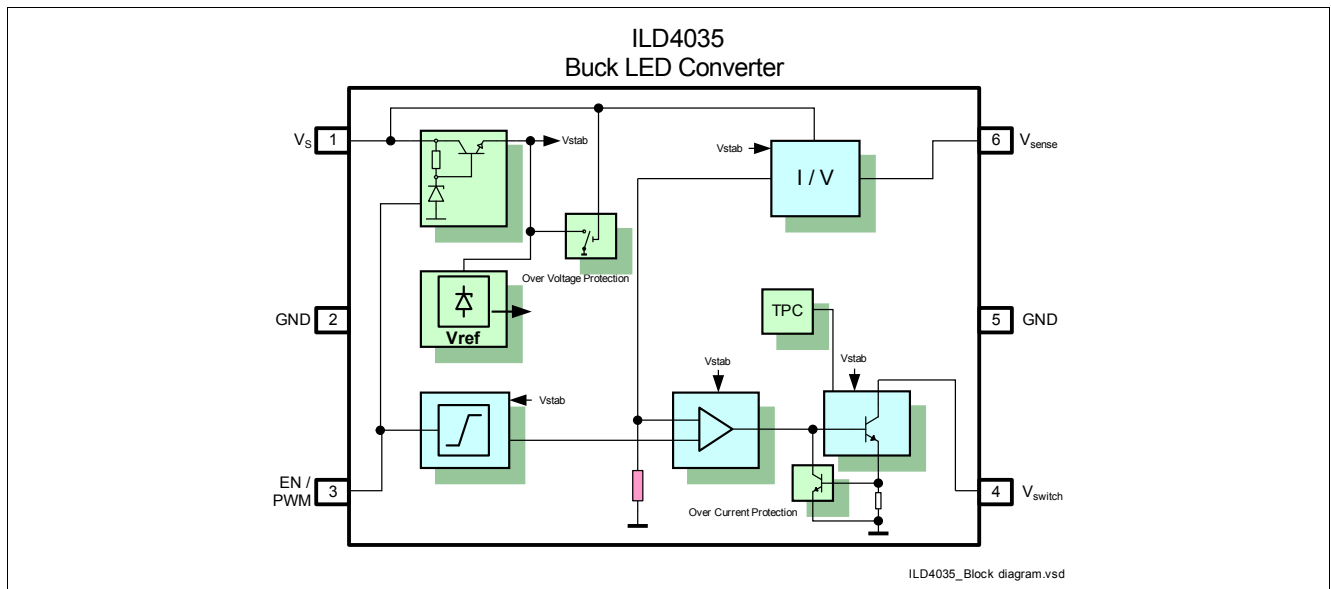

**Figure 1 Block Diagram**

## Pin Definition

**Table 1 Pin Definition and Function**

Pin No.	Name	Pin Type	Buffer Type	Function
1	$V_s$	Input	–	Supply voltage
2	GND	GND	–	IC ground
3	EN / PWM	Input	–	Multifunctional pin: <ul style="list-style-type: none"><li>• Chip enable signal</li><li>• Analog dimming signal</li><li>• PWM dimming signal</li></ul>
4	$V_{switch}$	Output	–	Power switch output
5	GND	GND	–	IC ground
6	$V_{sense}$	Input	–	LED current sense input

### 3 Maximum Ratings

Table 2 Maximum Ratings

Parameter	Symbol	Values			Unit	Note / Test Condition
		Min.	Typ.	Max.		
Supply voltage	$V_S$	–	–	45	V	–
Peak output current	$I_{Switch}$	–	–	550	mA	Hysteretic peak current
Total power dissipation, $T_s \leq 85^\circ\text{C}$	$P_{tot}$	–	–	1000	mW	–
Junction temperature	$T_J$	–	–	150	$^\circ\text{C}$	–
Storage temperature range	$T_{STG}$	-65	–	150	$^\circ\text{C}$	–
ESD capability at all pins	$V_{ESD\ HBM}$	–	–	4	kV	HBM acc. to JESD22-A114

**Attention: Stresses above the max. values listed here may cause permanent damage to the device. Exposure to absolute maximum rating conditions for extended periods may affect device reliability. Maximum ratings are absolute ratings; exceeding only one of these values may cause irreversible damage to the integrated circuit.**

## 4 Thermal Characteristics

**Table 3 Maximum Thermal Resistance**

Parameter	Symbol	Values			Unit	Note / Test Condition
		Min.	Typ.	Max.		
Junction - soldering point <sup>1)</sup>	$R_{thJS}$	–	–	65	K/W	–

1) For calculation of  $R_{thJA}$  please refer to application note AN077 (Thermal Resistance Calculation)

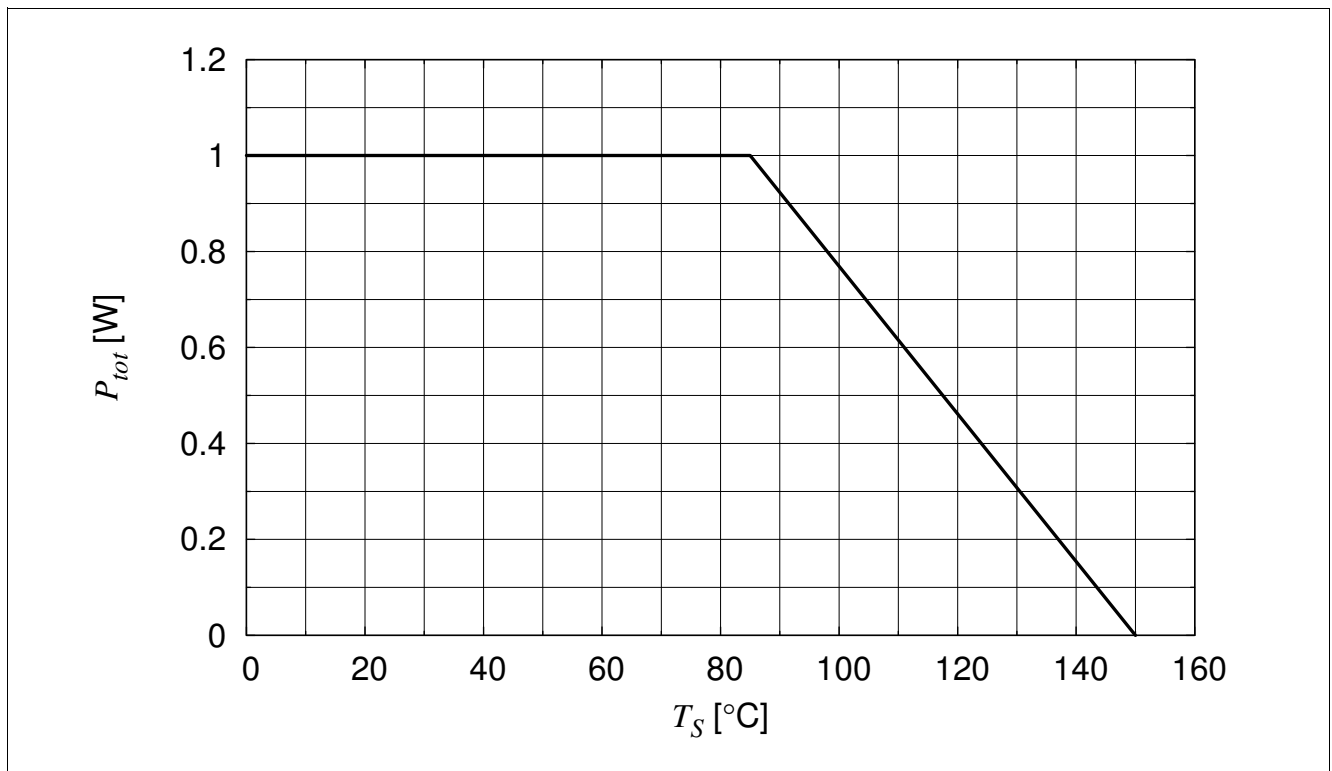
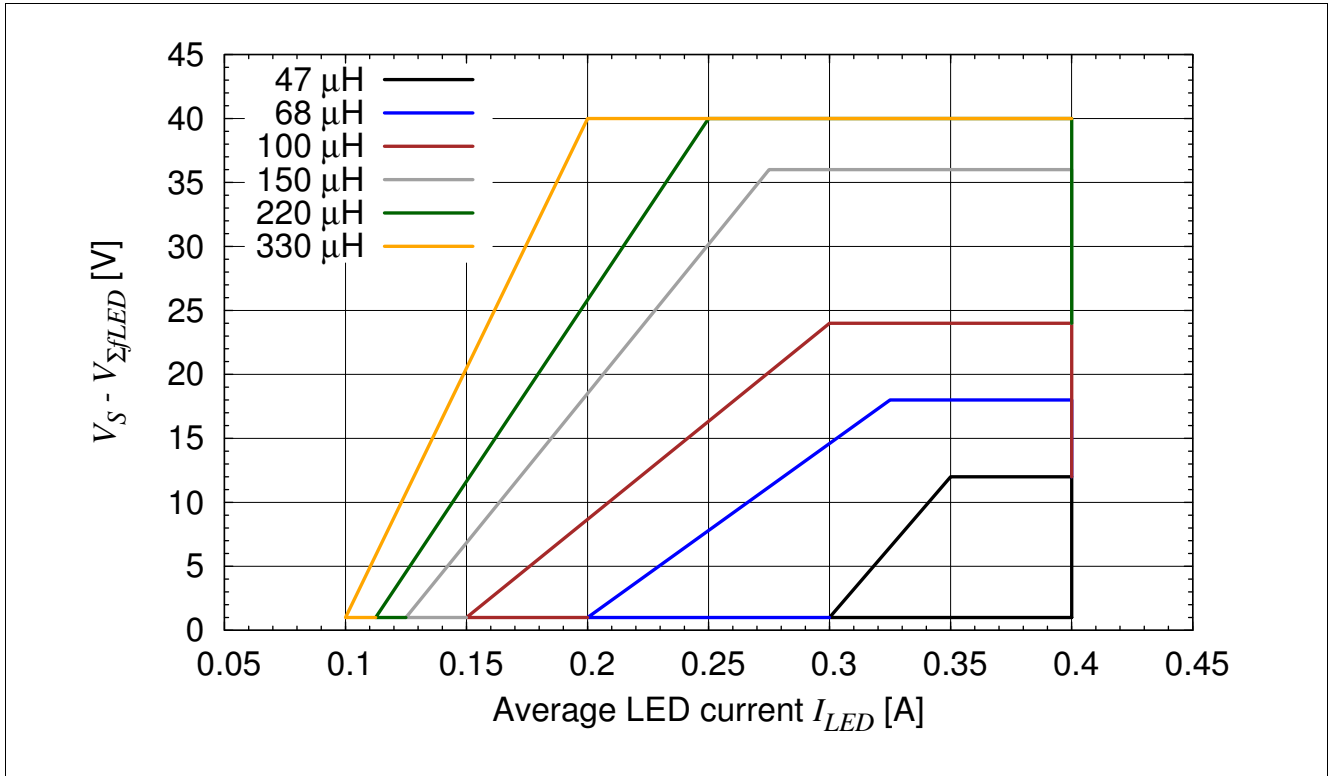

**Figure 2 Total Power Dissipation**

**Equation (1)** gives an estimation for the power dissipation of ILD4035.

$$P_{tot} = 1.1V \cdot I_{LED} \cdot \text{duty cycle} + f_{Switch} \cdot 1 \mu W \cdot \frac{I_{LED}}{350 mA}$$

(1)



**Figure 3 Safe Operating Area**

**Figure 3** shows the safe operating area for the respective inductance values. The safe operating area consists of the minimum and maximum allowed average LED current and the resulting voltage overhead. The voltage overhead  $V_{overhead}$  is the difference between the supply voltage  $V_S$  and the sum of the LED forward voltages  $V_{\Sigma LED}$ .

**Example calculation 1**

3 LEDs in series,  $V_{fLED} = 3V$ ,  $I_{LED} = 350\text{ mA}$ ,  $V_S = 12\text{ V}$

$$V_{overhead} = V_S - V_{\Sigma fLED} = 12\text{ V} - 9\text{ V} = 3\text{ V}$$

→ any of the above coil values can be used

**Example calculation 2**

6 LEDs in series,  $V_{fLED} = 3V$ ,  $I_{LED} = 250\text{ mA}$ ,  $V_S = 24\text{ V}$

$$V_{overhead} = V_S - V_{\Sigma fLED} = 24\text{ V} - 18\text{ V} = 6\text{ V}$$

→ the coil values needs to be at least 68  $\mu\text{H}$

Outside the safe operating area the switching frequency, hysteric peak current and associated power dissipation  $P_{tot}$  of ILD4035 will increase beyond the maximum ratings.

## 5 Electrical Characteristics

### 5.1 DC Characteristics

All parameters at  $T_A = 25\text{ }^\circ\text{C}$ , unless otherwise specified.

$V_S = 12\text{ V}$ , 3 LEDs,  $R_{sense} = 303\text{ m}\Omega$  ( $I_{LED} = 375\text{ mA}$ ),  $L = 100\text{ }\mu\text{H}$ ,  $V_{EN} = 3\text{ V}$ ,  $V_{fLED} = 3\text{ V}$

**Table 4 DC Characteristics**

Parameter	Symbol	Values			Unit	Note / Test Condition
		Min.	Typ.	Max.		
Supply voltage	$V_S$	4.5	–	40	V	
Overall current consumption open load	$I_{S\ open\ load}$	1.4	2.3	3.1	mA	$V_S = 4.5\text{ V}$ $I_{LED} = 0\text{ mA}$
Overall current consumption open load	$I_{S\ open\ load}$	1.5	2.4	3.2	mA	$V_S = 12\text{ V}$ $I_{LED} = 0\text{ mA}$
Overall current consumption open load	$I_{S\ open\ load}$	1.8	3.0	3.9	mA	$V_S = 40\text{ V}$ $I_{LED} = 0\text{ mA}$
Overall standby current consumption	$I_{S\ standby}$	–	–	1	$\mu\text{A}$	$V_{EN} = 0\text{ V}$ ; $V_S = 12\text{ V}$
Overall standby current consumption	$I_{S\ standby}$	–	–	5	$\mu\text{A}$	$V_{EN} = 0\text{ V}$ ; $V_S = 40\text{ V}$
Enable voltage for standby mode	$V_{EN}$	-0.3	–	0.4	V	
Enable voltage for analog dimming	$V_{EN}$	1	–	2	V	linear dimming range
Input current of multifunctional control pin	$I_{EN}$	–	50	140	$\mu\text{A}$	$V_{EN} = 3\text{ V}$ $V_S = 4.5..40\text{ V}$
Current of sense input	$I_{sense}$	–	20	–	$\mu\text{A}$	at any LED current
Over temperature protection	$T_{S,TSD}$	–	113	–	$^\circ\text{C}$	$T_S$ for 10 % $I_{LED}$ reduction, defined by $T_J$

## 5.2 Switching Characteristics

All parameters at  $T_A = 25\text{ }^\circ\text{C}$ , unless otherwise specified.

$V_S = 12\text{ V}$ , 3 LEDs,  $R_{sense} = 303\text{ m}\Omega$  ( $I_{LED} = 375\text{ mA}$ ),  $L = 100\text{ }\mu\text{H}$ ,  $V_{EN} = 3\text{ V}$ ,  $V_{fLED} = 3\text{ V}$

**Table 5 Switching Characteristics**

Parameter	Symbol	Values			Unit	Note / Test Condition
		Min.	Typ.	Max.		
Switching frequency	$f_{Switch}$	–	120	–	kHz	
Maximum switching frequency	$f_{Switch\ max}$	–	–	500	kHz	for any coil value
Mean current sense threshold voltage	$V_{sense}$	–	114	–	mV	
Sense threshold hysteresis	$V_{sensehys}$	–	$\pm 7.5$	–	%	
Residual voltage at collector of power transistor	$V_{switch\ on}$	–	1.1	–	V	output switch turned on
Output current accuracy	$I_{outacc}$	–	$\pm 3$	–	%	

## 5.3 Digital Signals

All parameters at  $T_A = 25\text{ }^\circ\text{C}$ , unless otherwise specified.

**Table 6 Digital Control Parameter at Pin EN/PWM**

Parameter	Symbol	Values			Unit	Note / Test Condition
		Min.	Typ.	Max.		
Input voltage for power on	$V_{On}$	2.5	3	40	V	full LED current
Input voltage for power off	$V_{Off}$	-0.3	–	0.4	V	
Min. power on puls duration	$t_{On}$	10	–		$\mu\text{s}$	

## 6 Basic Application Information

This section covers the basic information required for calculating the parameters for a certain LED application. For detailed application information please check the Application Note **AN215** (Driving 1 W LEDs with ILD4035) or visit our web site <http://www.infineon.com/led.appnotes>

### 6.1 Setting the average LED current

The average output current for the LEDs is set by the external sense resistor  $R_{sense}$ . To calculate the value of this resistor a first approximation can be calculated using **Equation (2)**.

$V_{sense}$  is dependent on the supply voltage  $V_S$  and the number of LEDs in series.

$$R_{sense} = \frac{V_{sense}}{I_{LED}} \quad (2)$$

#### Example calculation 1

$V_S = 12\text{ V}$ ,  $100\ \mu\text{H}$ ,  $V_{fLED} = 3\text{ V}$ , 3 LEDs in series

→  $V_{sense} = 114\text{ mV}$

$I_{LED} = 375\text{ mA}$

→  $R_{sense} = 303\text{ m}\Omega$

#### Example calculation 2

$V_S = 24\text{ V}$ ,  $100\ \mu\text{H}$ ,  $V_{fLED} = 3\text{ V}$ , 6 LEDs in series

→  $V_{sense} = 106\text{ mV}$

$I_{LED} = 350\text{ mA}$

→  $R_{sense} = 303\text{ m}\Omega$

An easy way to achieve these resistor values is to connect standard resistors in parallel

### 6.2 Dimming of the LEDs

#### Analog voltage dimming

The voltage level of the EN/PWM pin can be used for analog dimming of the LED current. To achieve a linear change in LED current versus control voltage the recommended voltage range at the EN/PWM pin is 1 V to 2 V. The maximum achievable LED current is defined by resistor  $R_{sense}$ . The maximum LED current will be achieved for  $V_{EN} \geq 2.5\text{ V}$ . Below 0.4 V the ILD4035 is set to standby mode and the output is switched off. The typical dimming performance is shown in below figures.



$I_{LED}$  versus  $V_{EN}$ ,  $T_A=25\text{ }^\circ\text{C}$

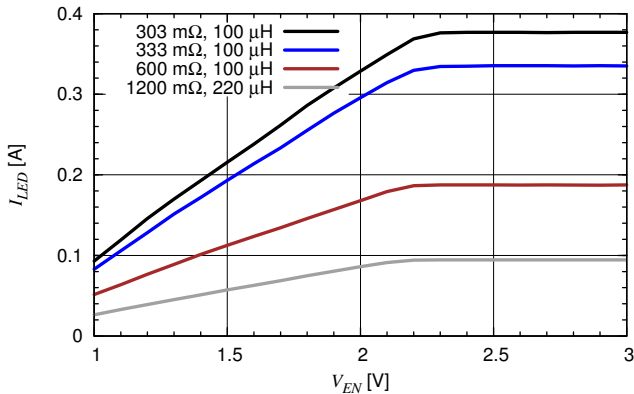

$I_{LED}$  (relative) versus  $V_{EN}$ ,  $T_A=25\text{ }^\circ\text{C}$

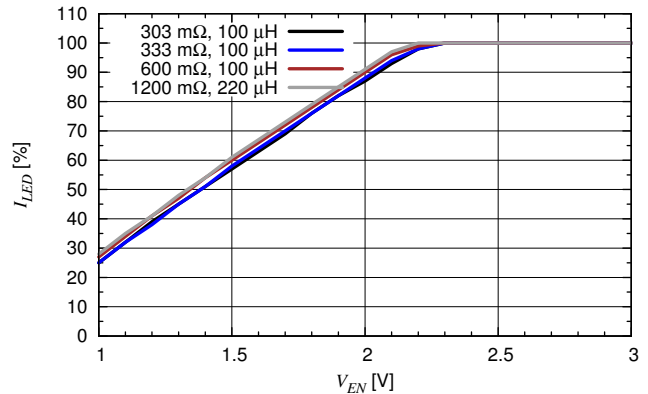

$I_{LED}$  versus  $V_{EN}$ , 333 mΩ, 100 μH

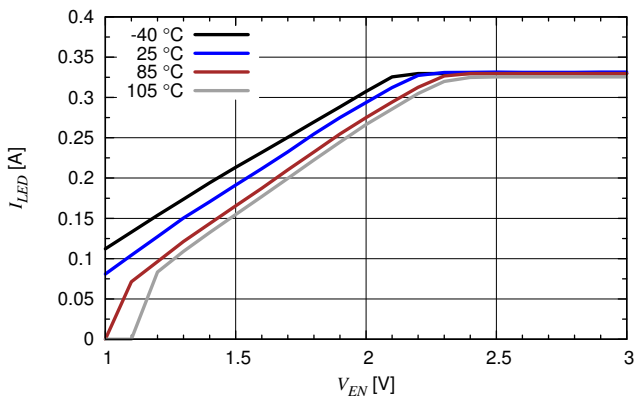

### PWM Dimming

Besides the analog dimming functionality the EN/PWM pin acts as input for a pulse width modulated (PWM) signal to control the dimming of the LED string. For PWM dimming the signal's logic high level should be at least 2.5 V and the PWM frequency should be lower than 5 kHz. For the ILD4035/4001 demo board a dimming frequency less than 330 Hz is recommended to maintain a maximum contrast ratio of 100:1. The achievable contrast ratio is shown on [Figure 4](#) based on the measured average LED current deviating 3 dB from the linear reference. The maximum contrast ratio depends mainly on the rise time of the inductor current and is thus dependent on supply voltage, inductor size and LED string forward voltage.

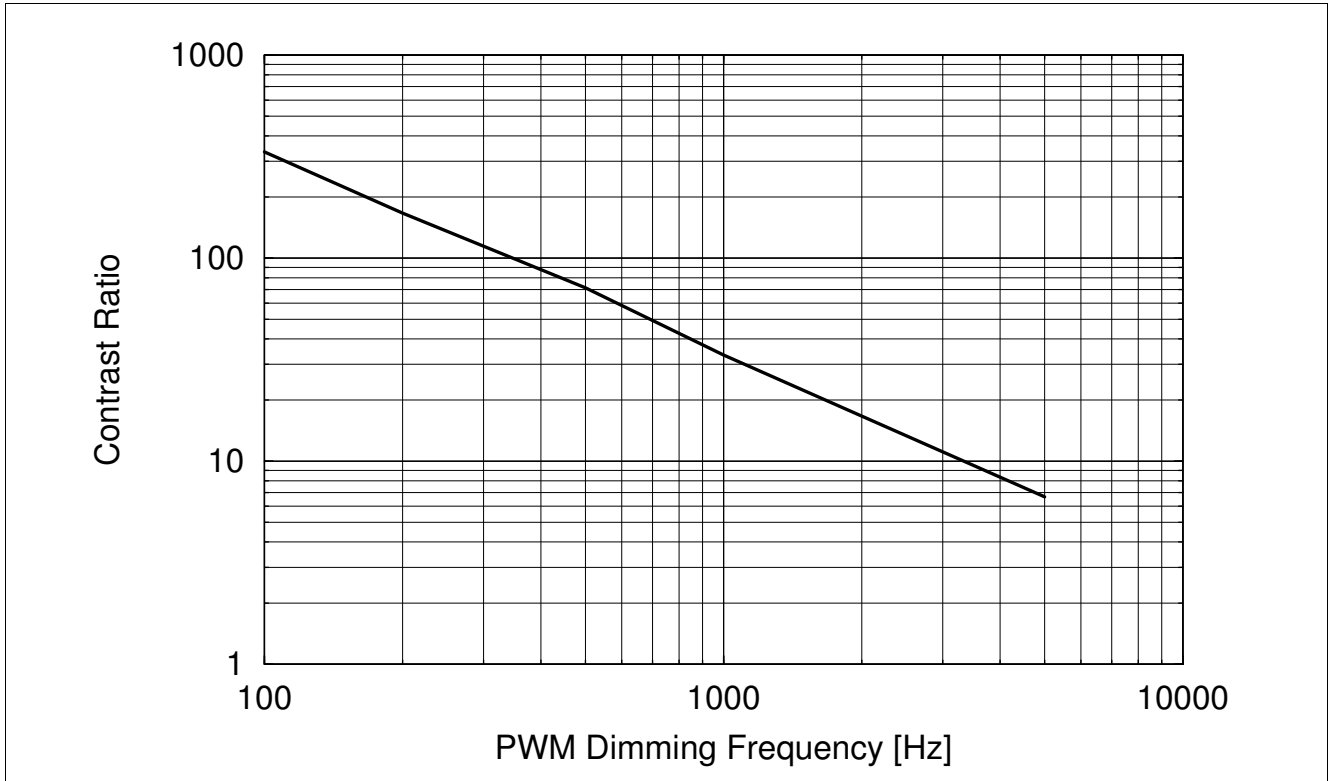

Figure 4 PWM Dimming

### 6.3 Temperature Protection Circuit

ILD4035 incorporates a temperature protection circuit referring to the junction temperature of ILD4035. The higher the junction temperature of ILD4035 the lower the current of the LEDs. This feature helps to reduce the power dissipation of ILD4035 and the LEDs. Yet still the product specific maximum ratings for junction temperature need to be observed to avoid a permanent damage of the devices.

ILD4035 has been characterized on ILD4035/4001 application board heated from the backside without additional air flow on the circuit board surface besides natural convection. Design and layout of the circuit board as well as the air flow influence the thermal resistance junction to ambient  $R_{thJA}$  of ILD4035 and thus its junction temperature. Below figures show the LED current versus soldering point temperature  $T_S$ .

LED current versus  $T_S$ ,  $V_S = 12\text{ V}$

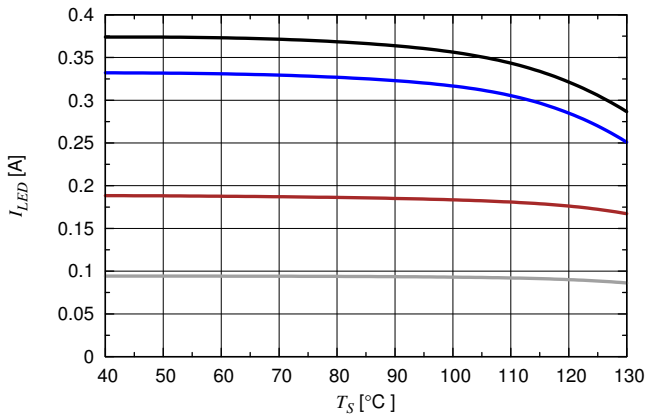

303 mΩ, 100 μH    600 mΩ, 100 μH    333 mΩ, 100 μH  
333 mΩ, 100 μH    1200 mΩ, 220 μH    333 mΩ, 100 μH

LED current (relative) versus  $T_S$ ,  $V_S = 12\text{ V}$

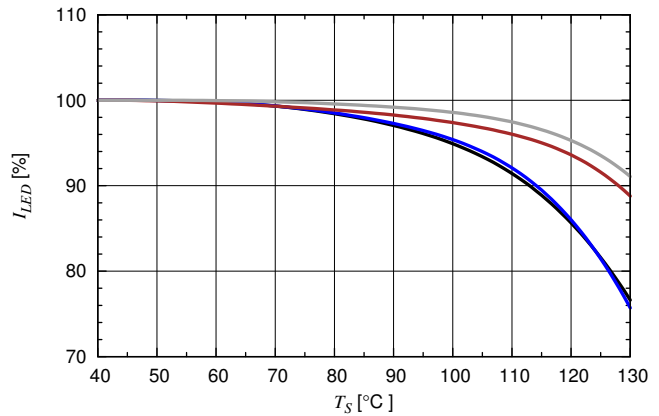

303 mΩ, 100 μH    600 mΩ, 100 μH    333 mΩ, 100 μH  
333 mΩ, 100 μH    1200 mΩ, 220 μH    333 mΩ, 100 μH

### 6.4 Switching Parameters

For all shown parameters ILD4035 has been measured on evaluation board ILD4035/4001 at  $T_A = 25\text{ °C}$ . Used LEDs have a typical forward voltage  $V_{fLED}$  of 3 V. For details see application note **AN215** (Driving 1W LEDs with ILD4035) or visit our web site <http://www.infineon.com/lowcostledrivers>.

$R_{sense} = 303 \text{ m}\Omega$ ,  $L = 47 \text{ }\mu\text{H}$

$I_{LED}$  versus  $V_S$  and Number of LEDs

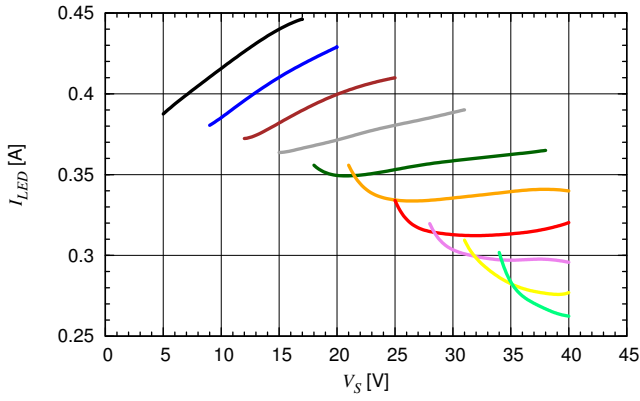

$f_{Switch}$  versus  $V_S$  and Number of LEDs

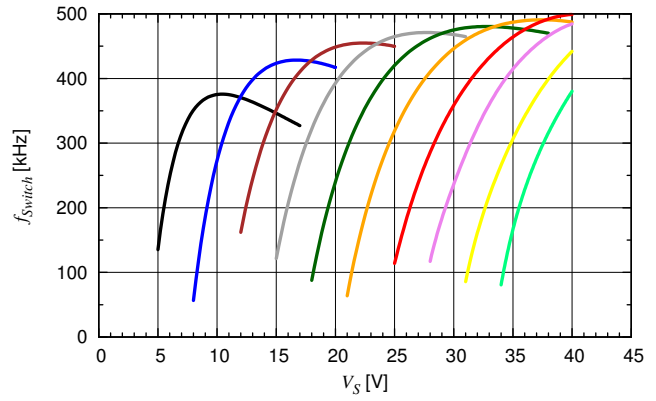

Efficiency versus  $V_S$  and Number of LEDs

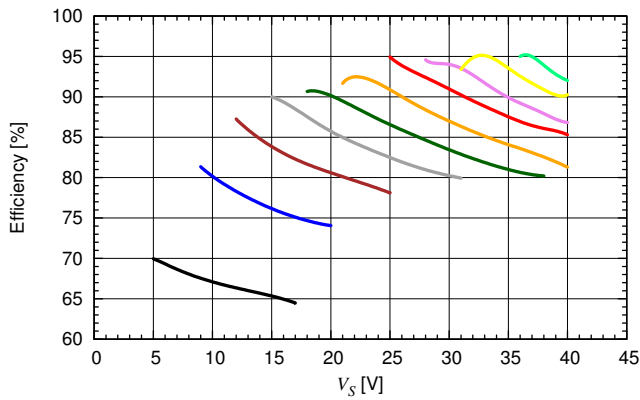

Duty Cycle versus  $V_S$  and Number of LEDs

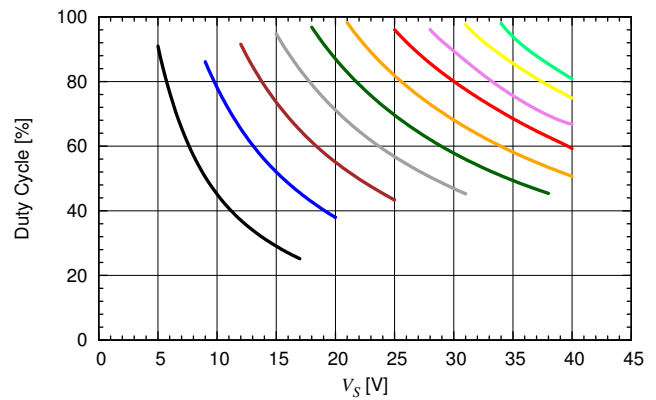

$R_{sense} = 303\text{ m}\Omega$ ,  $L = 68\text{ }\mu\text{H}$

$I_{LED}$  versus  $V_S$  and Number of LEDs

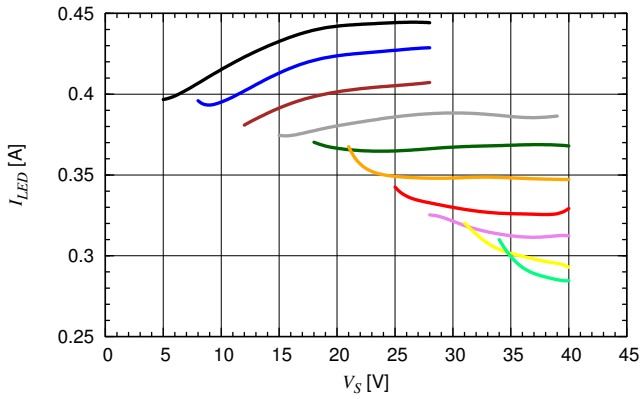

$f_{Switch}$  versus  $V_S$  and Number of LEDs

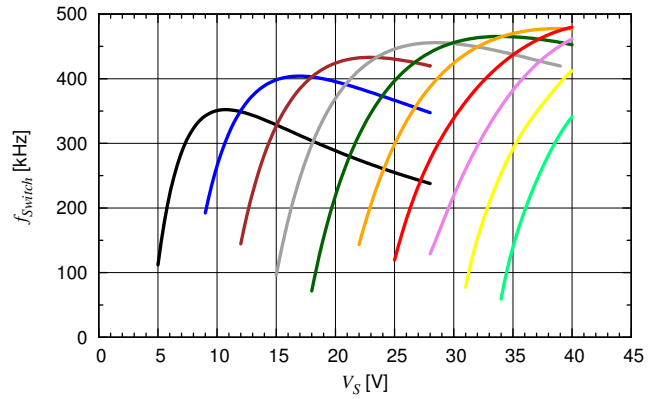

Efficiency versus  $V_S$  and Number of LEDs

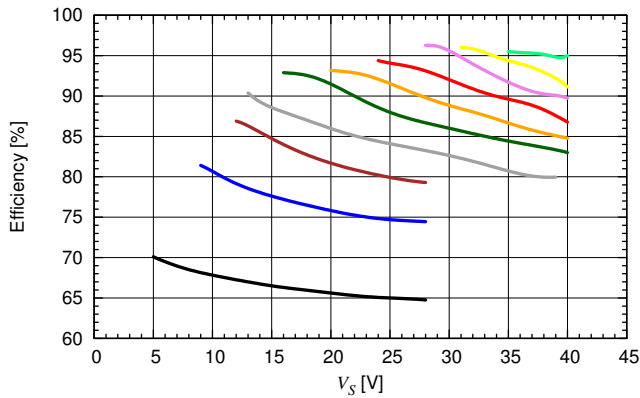

Duty Cycle versus  $V_S$  and Number of LEDs

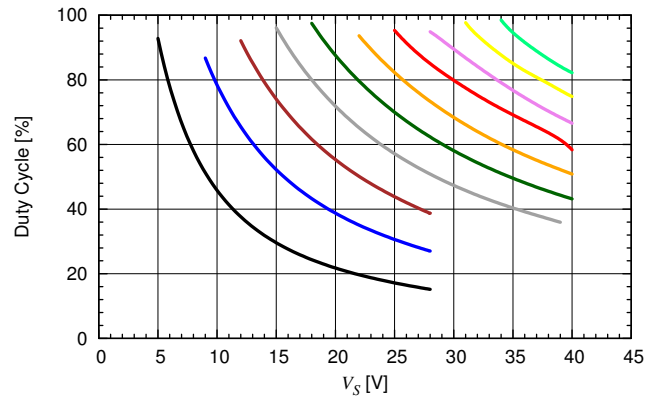

$R_{sense} = 303 \text{ m}\Omega$ ,  $L = 100 \text{ }\mu\text{H}$

$I_{LED}$  versus  $V_S$  and Number of LEDs

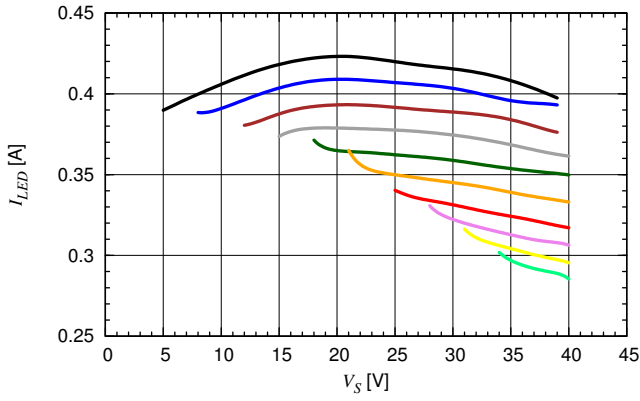

$f_{Switch}$  versus  $V_S$  and Number of LEDs

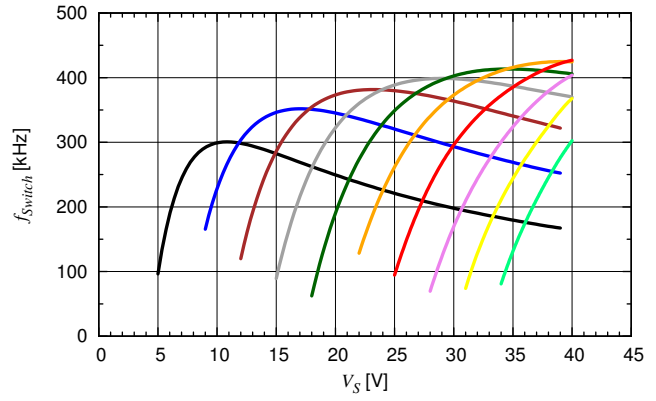

Efficiency versus  $V_S$  and Number of LEDs

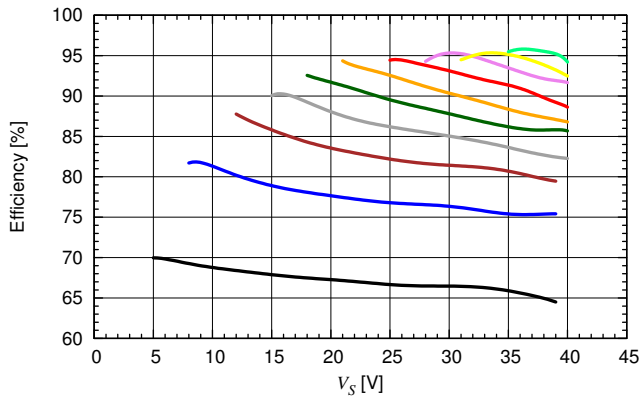

Duty Cycle versus  $V_S$  and Number of LEDs

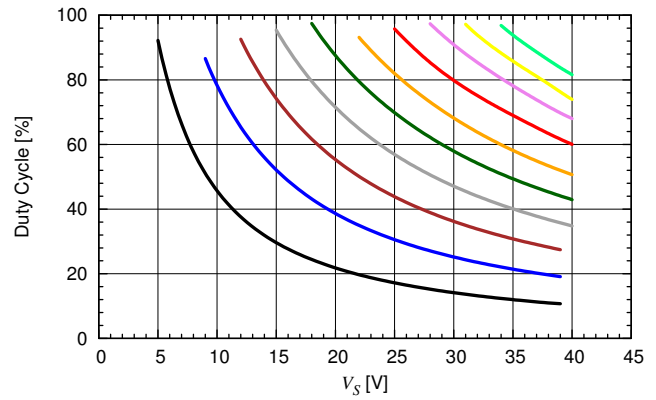

$R_{sense} = 303 \text{ m}\Omega$ ,  $L = 220 \text{ }\mu\text{H}$

$I_{LED}$  versus  $V_S$  and Number of LEDs

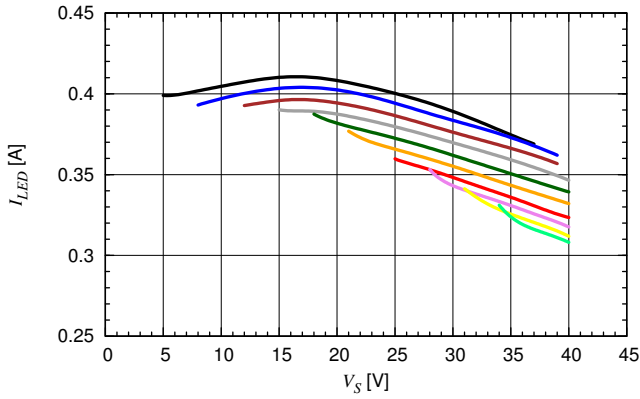

$f_{Switch}$  versus  $V_S$  and Number of LEDs

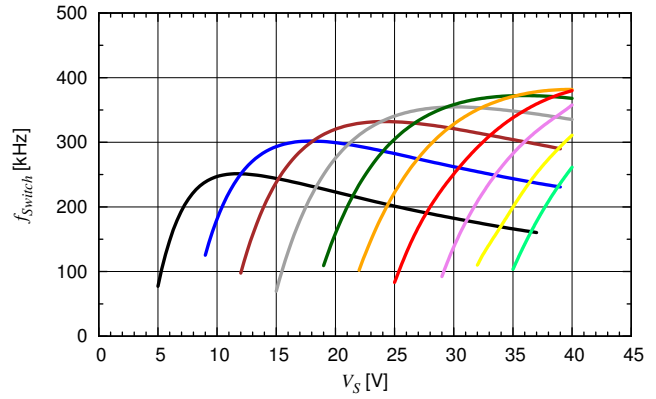

Efficiency versus  $V_S$  and Number of LEDs

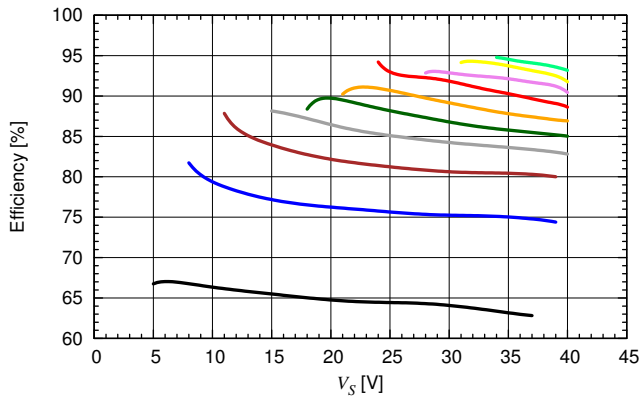

Duty Cycle versus  $V_S$  and Number of LEDs

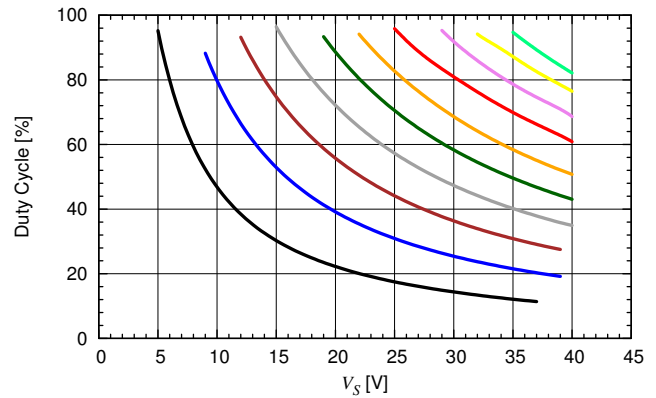

$R_{sense} = 367\text{ m}\Omega$ ,  $L = 47\text{ }\mu\text{H}$

$I_{LED}$  versus  $V_S$  and Number of LEDs

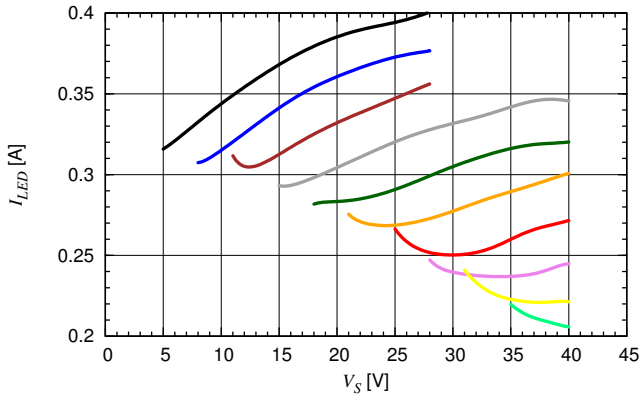

$f_{Switch}$  versus  $V_S$  and Number of LEDs

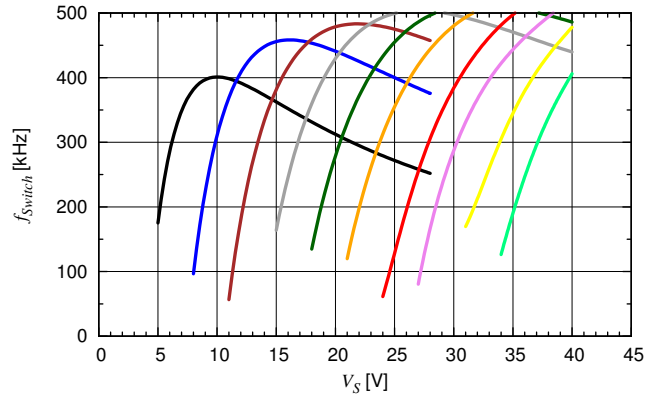

Efficiency versus  $V_S$  and Number of LEDs

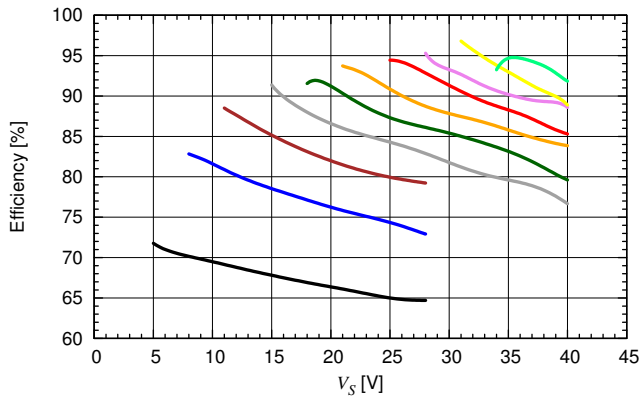

Duty Cycle versus  $V_S$  and Number of LEDs

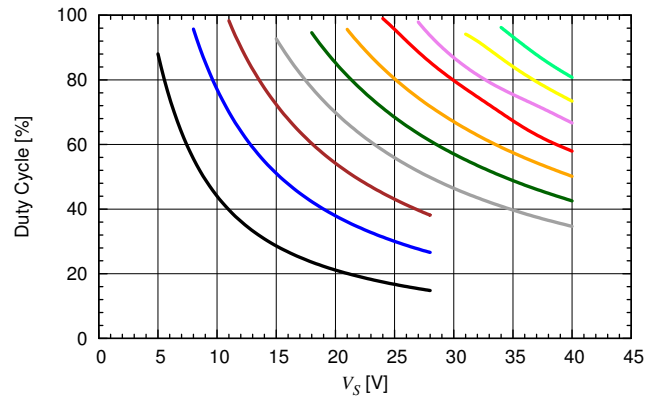



$R_{sense} = 367\text{ m}\Omega$ ,  $L = 68\text{ }\mu\text{H}$

$I_{LED}$  versus  $V_S$  and Number of LEDs

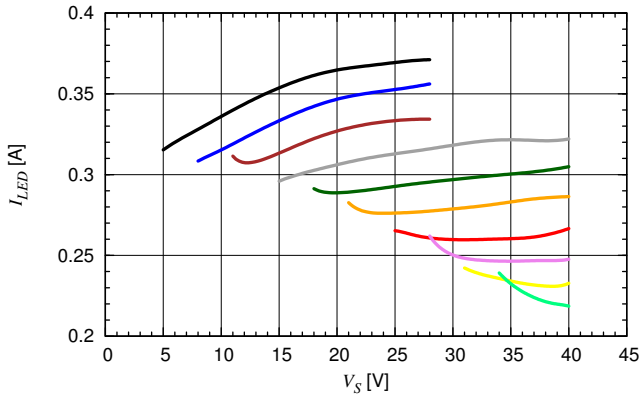

$f_{Switch}$  versus  $V_S$  and Number of LEDs

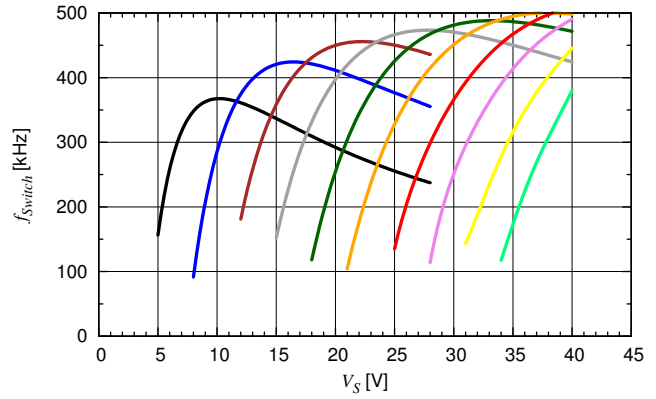

Efficiency versus  $V_S$  and Number of LEDs

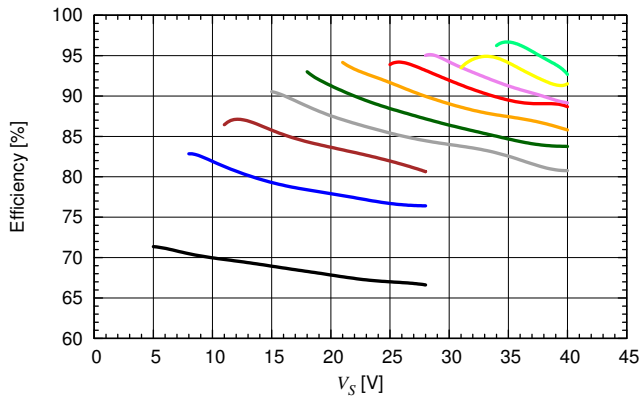

Duty Cycle versus  $V_S$  and Number of LEDs

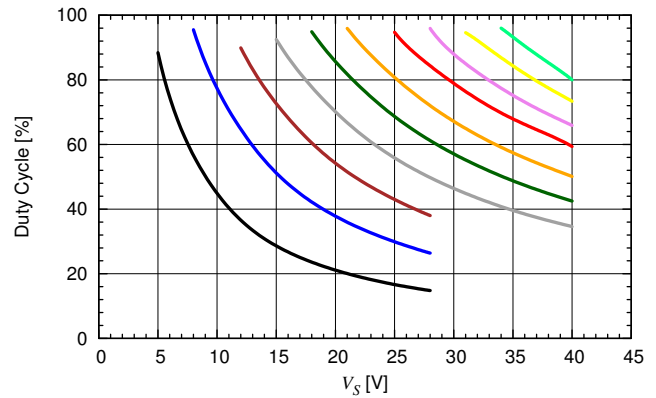

$R_{sense} = 367\text{ m}\Omega$ ,  $L = 100\text{ }\mu\text{H}$

$I_{LED}$  versus  $V_S$  and Number of LEDs

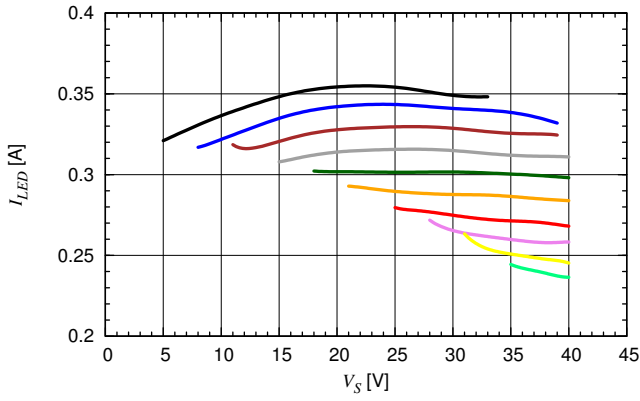

$f_{Switch}$  versus  $V_S$  and Number of LEDs

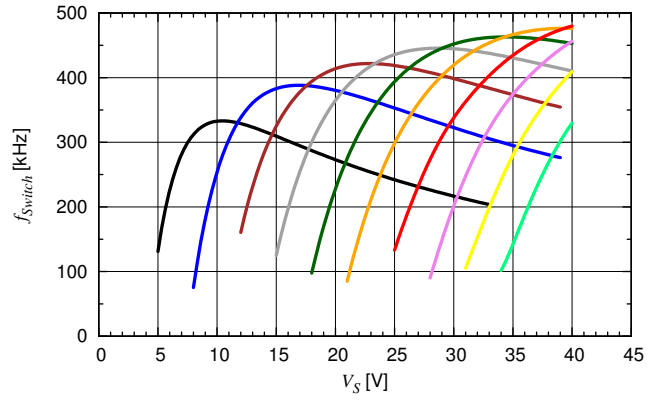

Efficiency versus  $V_S$  and Number of LEDs

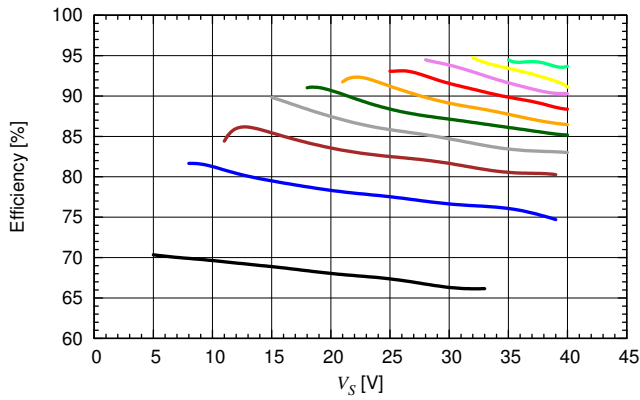

Duty Cycle versus  $V_S$  and Number of LEDs

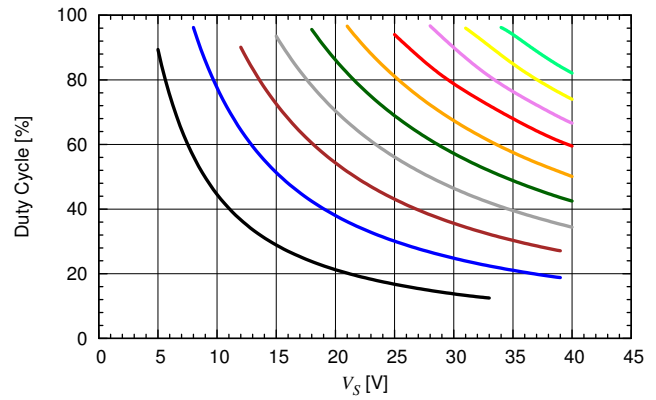

$R_{sense} = 367\text{ m}\Omega$ ,  $L = 220\text{ }\mu\text{H}$

$I_{LED}$  versus  $V_S$  and Number of LEDs

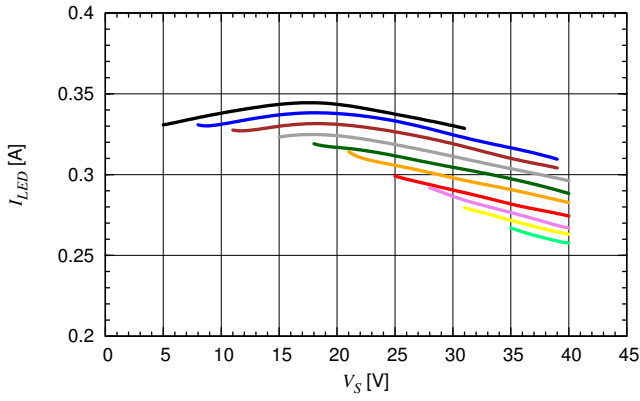

$f_{Switch}$  versus  $V_S$  and Number of LEDs

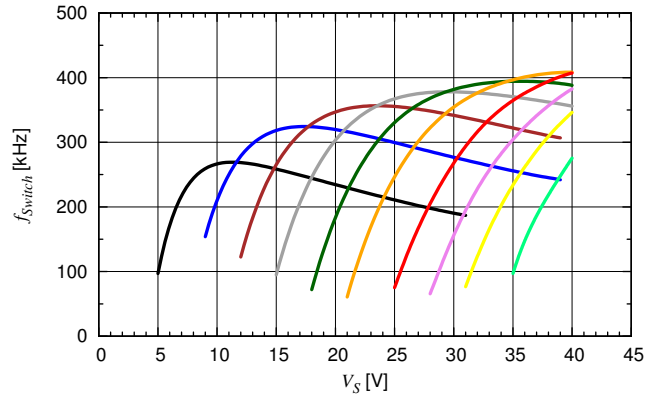

Efficiency versus  $V_S$  and Number of LEDs

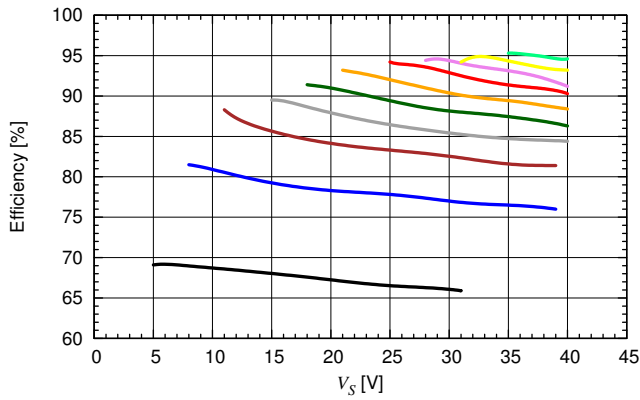

Duty Cycle versus  $V_S$  and Number of LEDs

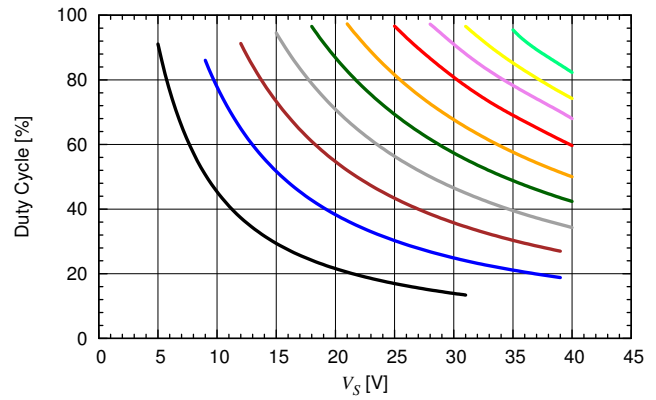

## 7 Application Circuit

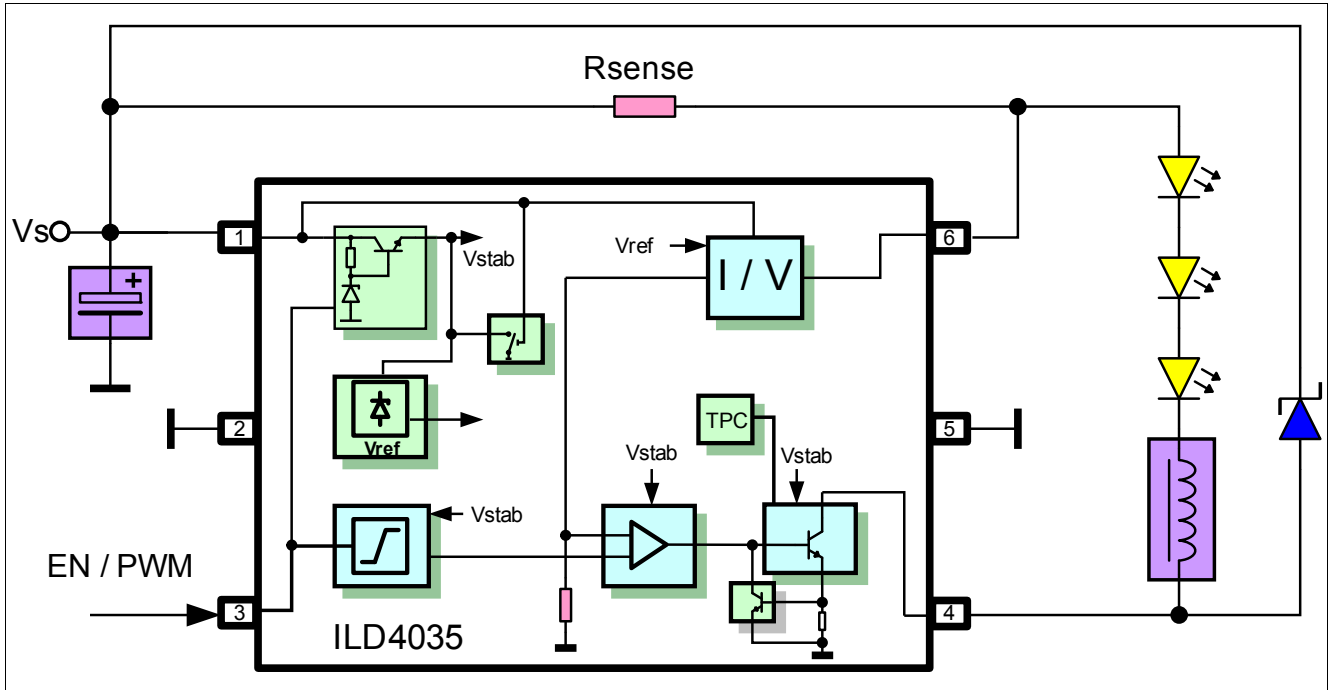

Figure 5 Application Circuit

## 8 Evaluation Board

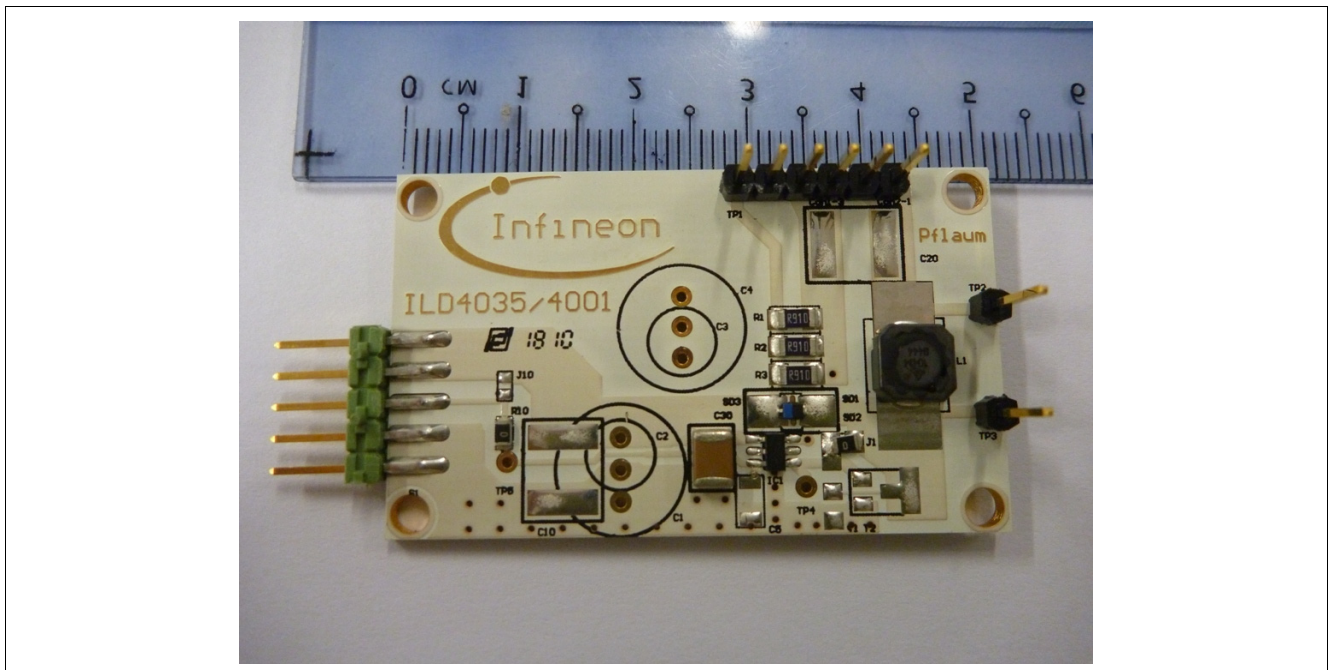

Figure 6 ILD4035 on Evaluation Board

## 9 Package Information

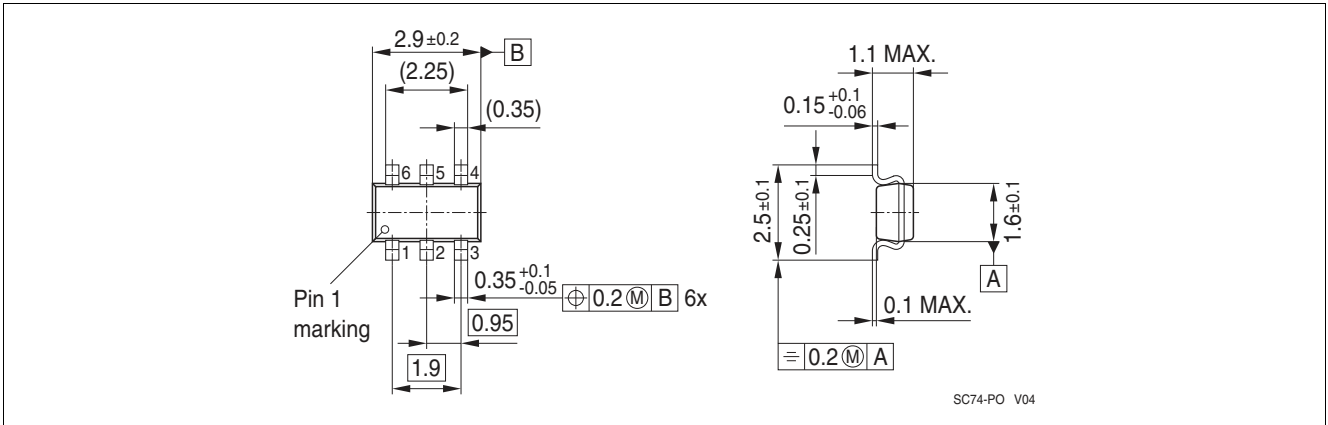

Figure 7 Package Outline SC74

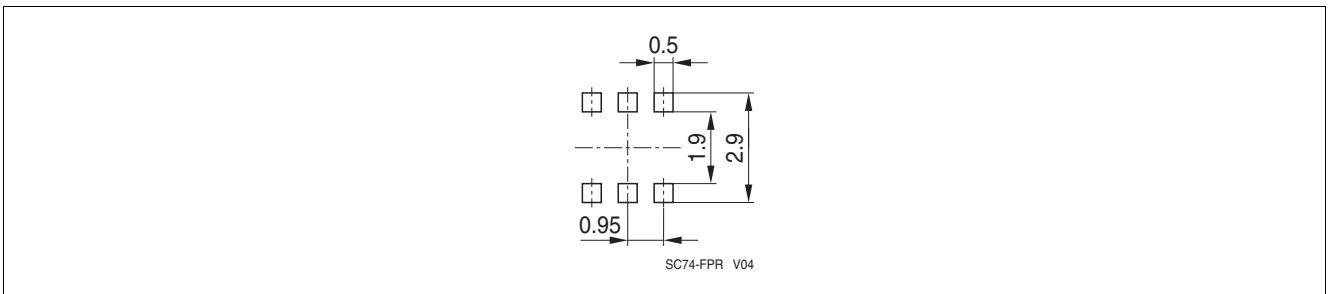

Figure 8 Recommended PCB Footprint for Reflow Soldering

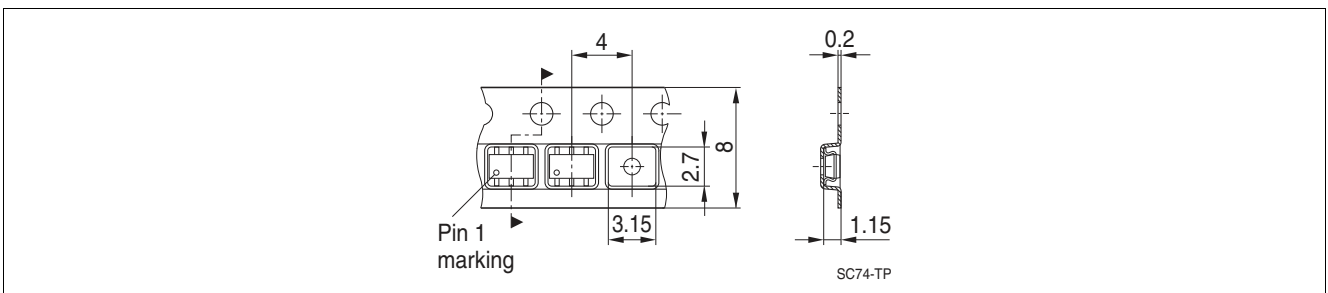

Figure 9 Tape Loading

[www.infineon.com](http://www.infineon.com)

Published by Infineon Technologies AG