

Evaluation Module for the TPS54561 Step-Down Converter

This user's guide contains information for the TPS54561EVM-555 evaluation module (PWR555) including the performance specifications, schematic, and the bill of materials.

Contents

1	Introduction	2
2	Test Setup and Results	5
3	Board Layout	11
4	Bill of Materials	14

List of Figures

1	TPS54561EVM-555 Board	2
2	TPS54561EVM-555 Schematic	3
3	Efficiency Versus Load Current	5
4	Light-Load Efficiency	5
5	Regulation Versus Output Current.....	6
6	Regulation Versus Input Voltage.....	6
7	Load Transient Response	6
8	Loop Response	6
9	Line Transient Response	7
10	Input Voltage Ripple CCM	7
11	Input Voltage Ripple DCM	7
12	Output Voltage Ripple CCM	8
13	Output Voltage Ripple DCM	8
14	Output Voltage Ripple Eco-mode.....	8
15	Start Up Relative to V_{IN}	9
16	Start Up Relative to EN	9
17	Prebias Start Up Relative to EN	9
18	Shutdown Relative to V_{IN}	10
19	Shutdown Relative to EN.....	10
20	Low Dropout Operation	10
21	Low Dropout Start Up and Shutdown.....	10
22	TPS54561EVM-555 Top Assembly and Silkscreen	11
23	TPS54561EVM-555 Layer 2 Layout	12
24	TPS54561EVM-555 Layer 3 Layout	12
25	TPS54561EVM-555 Bottom-Side Layout	13

List of Tables

1	Input Voltage and Output Current Summary	2
2	TPS54561EVM-555 Performance Specification Summary.....	3
3	R5 Values for Common Output Voltages	4

Eco-mode is a trademark of Texas Instruments.

4	EVM Connectors and Test points.....	5
5	TPS54561EVM-555 Bill of Materials.....	14

1 Introduction

This user's guide contains background information for the TPS54561 as well as support documentation for the TPS54561EVM-555 evaluation module (PWR555). Also included are the performance specifications, the schematic, and the bill of materials for the TPS54561EVM-555.

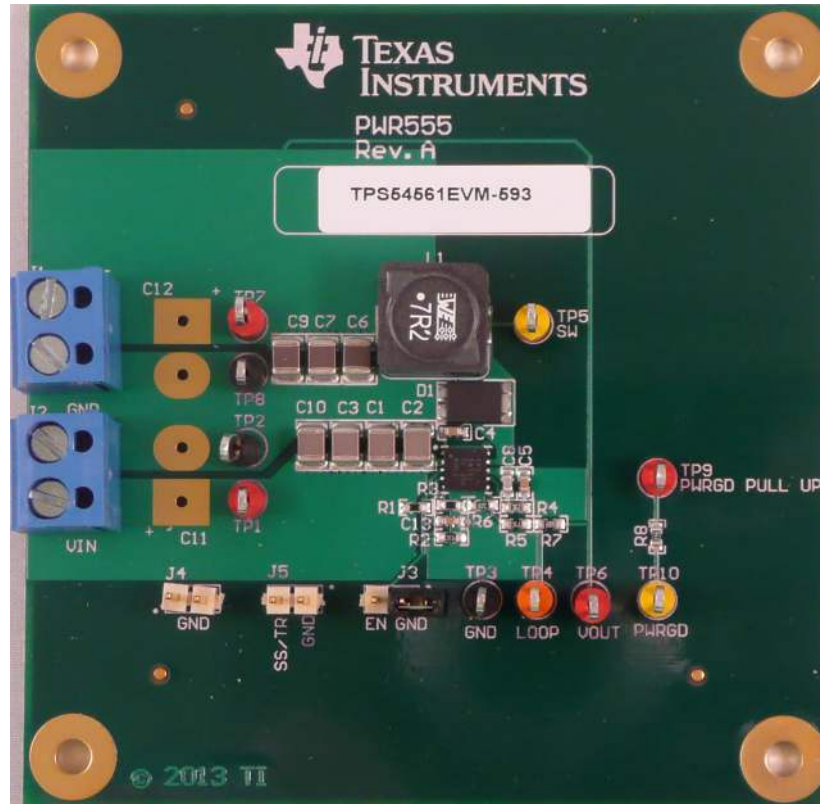

Figure 1. TPS54561EVM-555 Board

1.1 Background

The TPS54561 DC-DC converter is designed to provide up to a 5-A output from an input voltage source of 4.5 V to 60 V. Rated input voltage and output current range for the evaluation module are given in [Table 1](#). This evaluation module is designed to demonstrate the small, printed-circuit-board (PCB) areas that may be achieved when designing with the TPS54561 regulator. The switching frequency is externally set at a nominal 400 kHz. The high-side MOSFET is incorporated inside the TPS54561 package along with the gate-drive circuitry. The compensation components are external to the integrated circuit (IC), and an external resistor divider allows for an adjustable output voltage. Additionally, the TPS54561 provides an adjustable undervoltage lockout with hysteresis through an external resistor divider at the EN pin and adjustable soft-start with an external capacitor at the SS/TR pin. The SS/TR pin can also be used to have the output voltage track an external reference. Lastly, the PWRGD pin is an integrated open drain output power good signal. The absolute maximum input voltage is 60 V for the TPS54561EVM-555.

Table 1. Input Voltage and Output Current Summary

EVM	Input Voltage Range	Output Current Range
TPS54561EVM-555	$V_{IN} = 7 \text{ V to } 60 \text{ V}$	$I_{OUT} = 0 \text{ A to } 5 \text{ A}$

1.2 Performance Specification Summary

A summary of the TPS54561EVM-555 (EVM) performance specifications is provided in [Table 2](#). Specifications are given for an input voltage of $V_{IN} = 12\text{ V}$, an output voltage of 5 V, and an ambient temperature of 25°C, unless otherwise specified. This EVM is designed and tested for $V_{IN} = 7\text{ V}$ to 60 V.

Table 2. TPS54561EVM-555 Performance Specification Summary

Specification	Test Conditions	MIN	TYP	MAX	Unit
V_{IN} voltage range		7	12	60	V
Output voltage set point			5		V
Output current range	$V_{IN} = 7\text{ V}$ to 60 V	0		5	A
Line regulation	$I_{OUT} = 5\text{ A}$, $V_{IN} = 7\text{ V}$ to 60 V		$\pm 0.03\%$		
Load regulation	$V_{IN} = 12\text{ V}$, $I_{OUT} = 0.001\text{ A}$ to 5 A		$\pm 0.03\%$		
Load transient response	$I_{OUT} = 1.25\text{ A}$ to 3.75 A	Voltage change	-160		mV
		Recovery time	250		μs
	$I_{OUT} = 3.75\text{ A}$ to 1.25 A	Voltage change	160		mV
		Recovery time	250		μs
Loop bandwidth	$V_{IN} = 12\text{ V}$, $I_{OUT} = 5\text{ A}$		20		kHz
Phase margin	$V_{IN} = 12\text{ V}$, $I_{OUT} = 5\text{ A}$		67		°
Input voltage ripple	$I_{OUT} = 5\text{ A}$		480		mVpp
Output voltage ripple	$I_{OUT} = 5\text{ A}$		5		mVpp
Output rise time	10% to 90%		3.8		ms
Operating frequency			400		kHz
Maximum efficiency	TPS54561EVM-555, $V_{IN} = 12\text{ V}$, $I_{OUT} = 1.1\text{ A}$		92.4%		
DCM threshold	$V_{IN} = 12\text{ V}$		410		mA
Pulse skipping threshold	$V_{IN} = 12\text{ V}$		25		mA
No load input current	$V_{IN} = 12\text{ V}$		280		μA
UVLO start threshold			6.5		V
UVLO stop threshold			5.0		V

1.3 Schematic

Figure 2 is the schematic for the EVM.

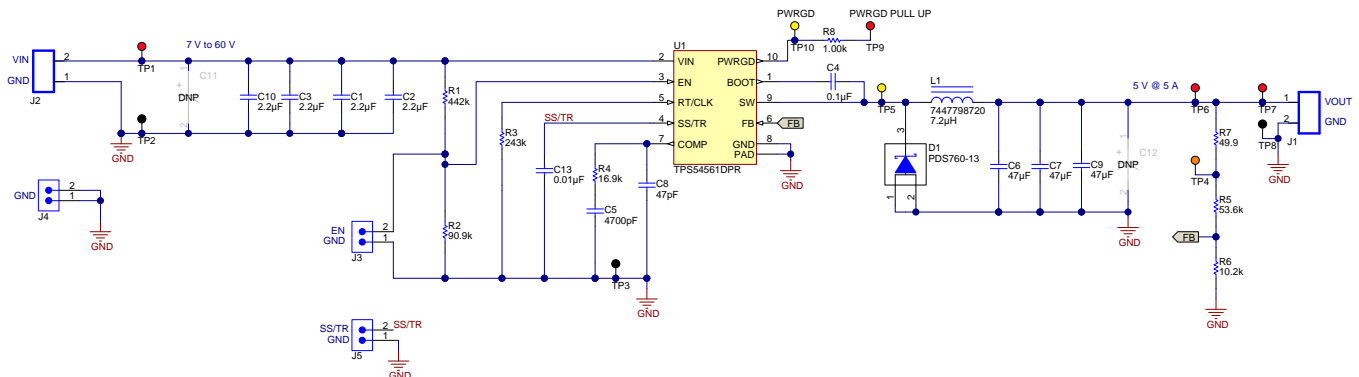

Figure 2. TPS54561EVM-555 Schematic

1.4 Modifications

These evaluation modules are designed to provide access to the features of the TPS54561. Some modifications can be made to this module. Component selection for modifications can be done with the aid of WEBENCH or the excel spreadsheet ([SLVC452](#)), located on the product page.

1.4.1 Output Voltage Set Point

To change the output voltage of the EVM, the value of resistor R5 (R_{HS}) should be changed while keeping R6 (R_{LS}) fixed. The output voltage can be adjusted to a minimum of the 0.8 V internal reference. The value of R5 for a specific output voltage can be calculated using [Equation 1](#):

$$R_{HS} = R_{LS} \times \left(\frac{V_{out} - 0.8V}{0.8V} \right) \quad (1)$$

[Table 3](#) lists the R5 values for some common output voltages, assuming R6 = 10.2 kΩ. Note V_{IN} must be in a range to keep the on time greater than the minimum on-time. The values given in [Table 3](#) are standard 1% values, not the exact value calculated using [Equation 1](#).

Table 3. R5 Values for Common Output Voltages

Output Voltage (V)	R5 Value (kΩ)
1.8	12.7
2.5	21.5
3.3	31.6
5.0	53.6

Be aware, changing the output voltage can affect the loop response. It may be necessary to modify the compensation components. Please see the TPS54561 data sheet ([SLVSBO1](#)) for details.

1.4.2 Operating Frequency, Soft-Start and UVLO

The operating frequency, soft-start time and UVLO voltage may also be adjusted. R3 sets the operating frequency, C13 sets the slow-start time and the resistor divider of R1 and R2 sets the UVLO start and stop voltages. Please see the TPS54561 data sheet ([SLVSBO1](#)) for details.

2 Test Setup and Results

This section describes how to properly connect, set up, and use the EVM. The section also includes test results typical for the EVM covering efficiency, output voltage regulation, load transients, loop response, output ripple, input ripple, start up, and shutdown. Measurements were taken at an ambient temperature of 25°C.

2.1 I/O Connections

This EVM includes I/O connectors and test points as shown in [Table 4](#). A power supply capable of supplying at least 5 A must be connected to J2 through a pair of 20-AWG wires. The load must be connected to J1 through a pair of 20-AWG wires. The maximum load-current capability must be 5 A. Wire lengths must be minimized to reduce losses in the wires. Test-point TP1 provides a place to monitor the V_{IN} input voltages with TP2 providing a convenient ground reference. TP3 is used to monitor the output voltage with TP4 as the ground reference.

Table 4. EVM Connectors and Test points

Reference Designator	Function
J1	V_{OUT} , 5 V at 5-A maximum
J2	V_{IN} (see Table 1 for V_{IN} range)
J3	EN jumper. Connect EN to ground to disable, open to enable.
J4	GND header for additional ground connections
J5	SS/TR header with GND reference for monitoring the soft-start or implementing sequencing/tracking
TP1	V_{IN} test point at V_{IN} connector
TP2	GND test point at V_{IN}
TP3	Output voltage test point at V_{OUT} connector
TP4	GND test point at V_{OUT} connector
TP5	SW test point
TP6	V_{OUT} test point used for loop response measurements
TP7	Test point between voltage divider network and output. Used for loop response measurements.
TP8	GND test point
TP9	Test point for pull up voltage of the open drain output power good signal
TP10	PWRGD test point

2.2 Efficiency

The efficiency of this EVM peaks at a load current of about 1.1 A with $V_{IN} = 12$ V, and then decreases as the load current increases towards full load. [Figure 3](#) shows the efficiency for the EVM. [Figure 4](#) shows the light-load efficiency for the EVM using a semi-log scale. The efficiency may be lower at higher ambient temperatures due to temperature variation in the drain-to-source resistance of the internal MOSFET.

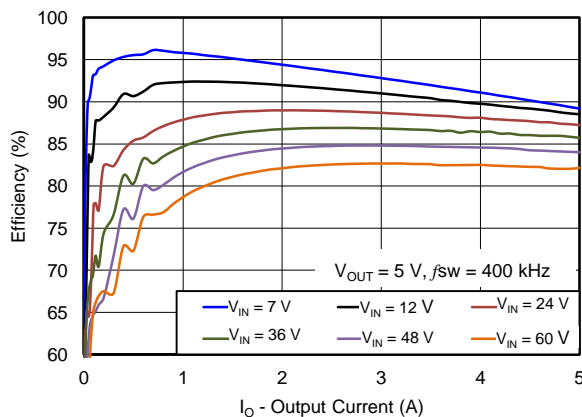

Figure 3. Efficiency Versus Load Current

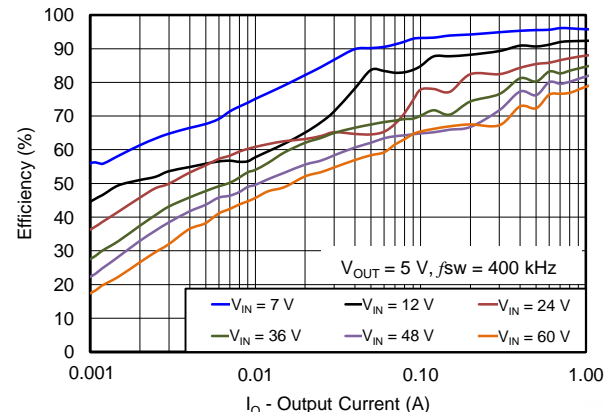

Figure 4. Light-Load Efficiency

2.3 Output Voltage Regulation

The load regulation for the EVM is shown in Figure 5. The line regulation for the EVM is shown in Figure 6.

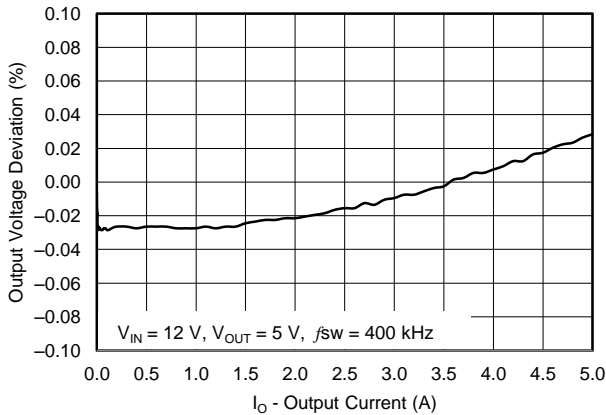

Figure 5. Regulation Versus Output Current

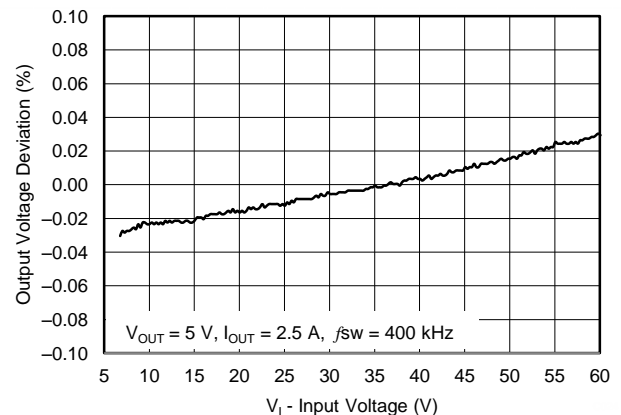

Figure 6. Regulation Versus Input Voltage

2.4 Load Transients and Loop Response

The EVM response to load transients is shown in Figure 7. The current step is from 25% to 75% of the maximum rated load at 12-V input. The current step slew rate is 100 mA/μs. Total peak-to-peak voltage variation is as shown, including ripple and noise on the output.

The EVM loop-response characteristics are shown in Figure 8. Gain and phase plots are shown for V_{IN} voltage of 12 V. Load current for the measurement is 5 A.

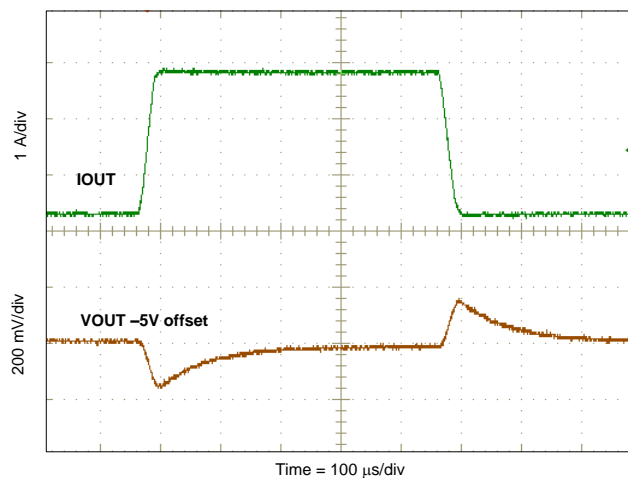

Figure 7. Load Transient Response

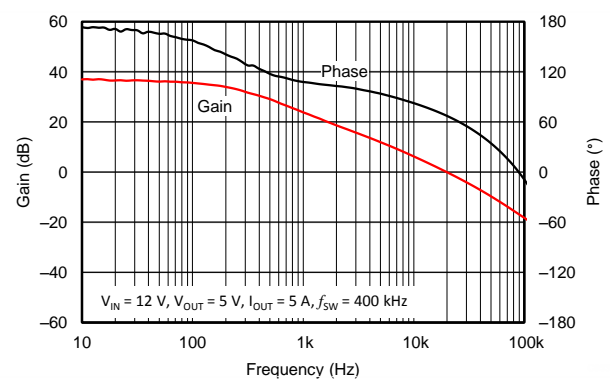

Figure 8. Loop Response

2.5 Line Transients

The EVM response to line transients is shown in Figure 9. The input voltage step is from 8 V to 40 V. Total peak-to-peak voltage variation is as shown, including ripple and noise on the output.

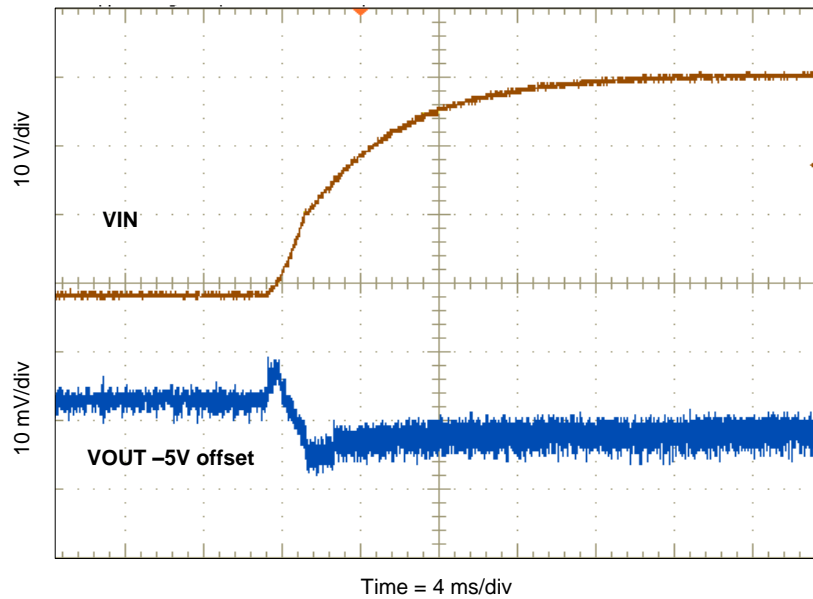

Figure 9. Line Transient Response

2.6 Input Voltage Ripple

The EVM CCM input voltage ripple is shown in Figure 10. The output current is the rated full load of 5 A and $V_{IN} = 12$ V. The voltage ripple is measured directly across the input capacitors.

The DCM input voltage ripple is shown in Figure 11. The output current is 0.1 A and $V_{IN} = 12$ V.

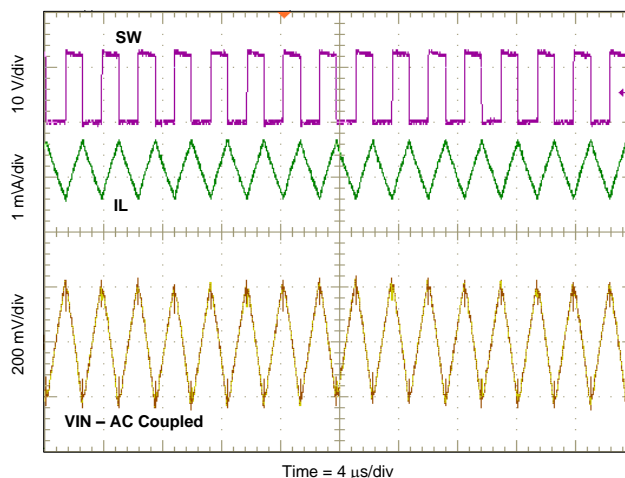

Figure 10. Input Voltage Ripple CCM

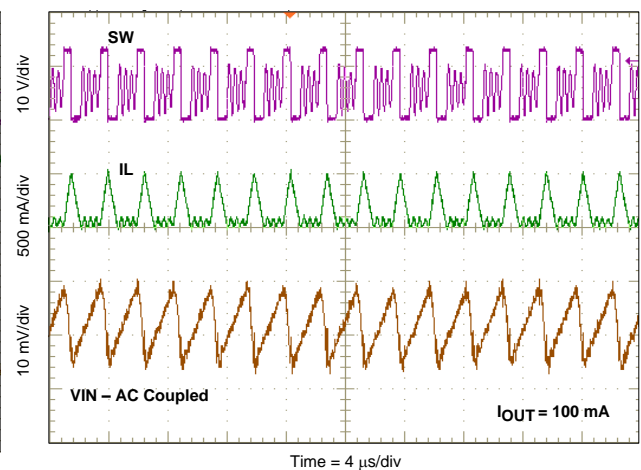

Figure 11. Input Voltage Ripple DCM

2.7 Output Voltage Ripple

The EVM CCM output voltage ripple is shown in Figure 12. The output current is the rated full load of 5 A and $V_{IN} = 12$ V. The voltage ripple is measured directly across the output capacitors.

The DCM output voltage ripple is shown in Figure 13. The output current is 0.1 A and $V_{IN} = 12$ V.

The Pulse Skip Eco-mode™ output voltage ripple is shown in Figure 14. There is no external load on the output and $V_{IN} = 12$ V.

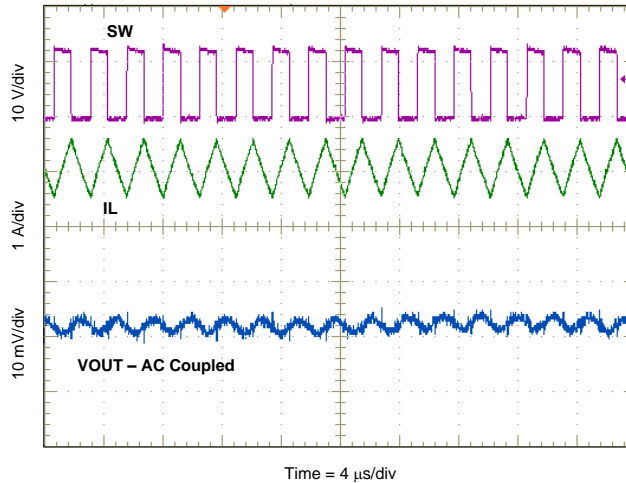

Figure 12. Output Voltage Ripple CCM

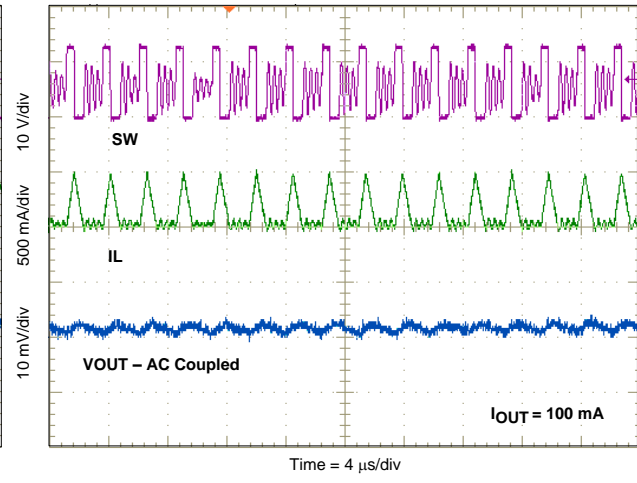

Figure 13. Output Voltage Ripple DCM

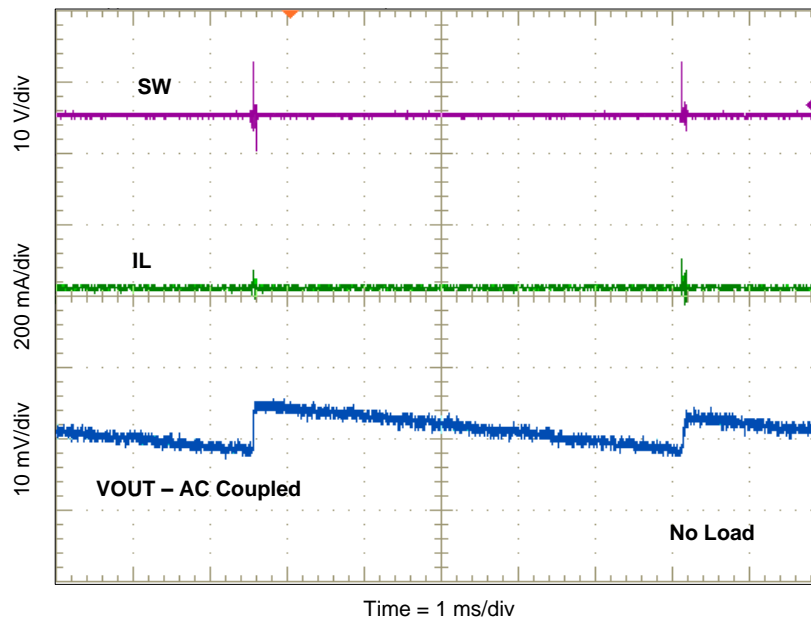

Figure 14. Output Voltage Ripple Eco-mode

2.8 Start Up

The start up waveforms are shown in [Figure 15](#), [Figure 16](#), and [Figure 17](#). The input voltage for these plots is 12 V with a 5-A resistive load. In [Figure 15](#) the top trace shows V_{IN} , the middle trace shows EN, and the bottom trace shows V_{OUT} . The input voltage is initially applied, and when the input reaches the undervoltage lockout threshold, the start up sequence begins and the output ramps up toward the set value of 5 V.

In [Figure 16](#) the input voltage is initially applied with EN held low. When EN is released, the start up sequence begins and the output ramps up toward the set value of 5 V.

In [Figure 17](#) the input voltage is initially applied with EN held low. An external voltage of 3.3 V is supplied to V_{OUT} . When EN is released, the start up sequence begins and the internal reference ramps up from 0 V with the internal soft-start. When the internal reference reaches the FB voltage the output begins ramping toward the set value of 5 V.

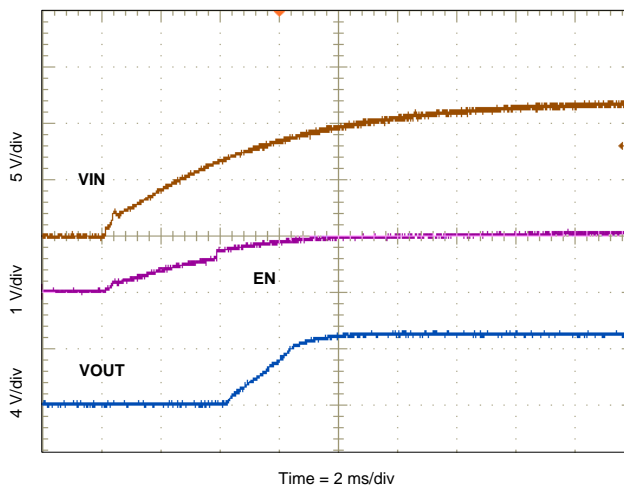

Figure 15. Start Up Relative to V_{IN}

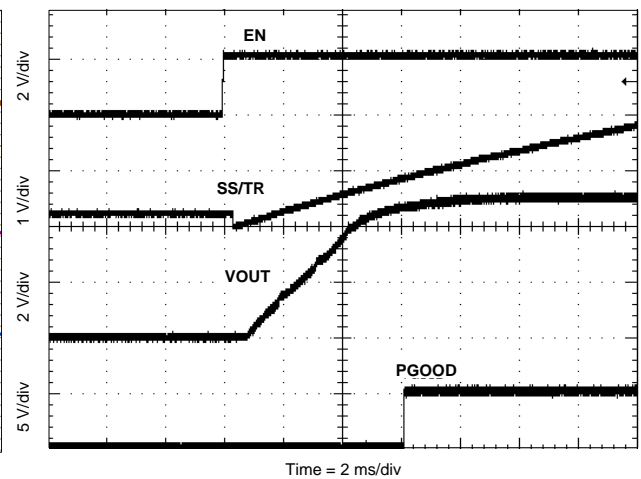

Figure 16. Start Up Relative to EN

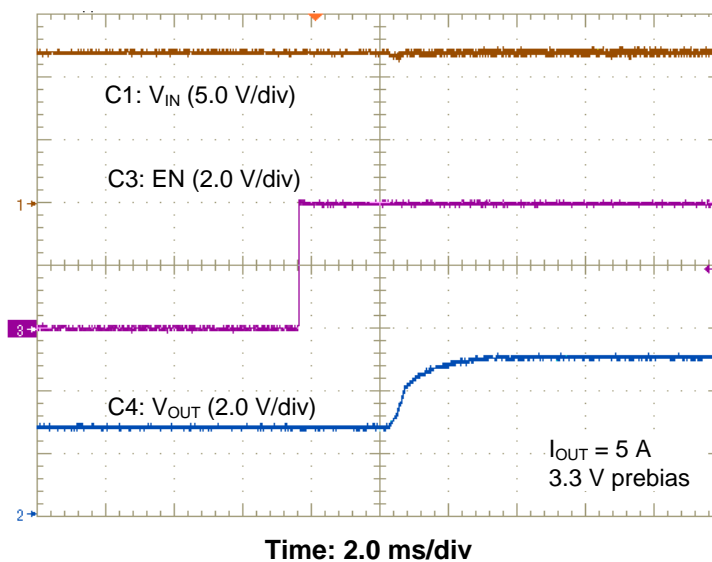
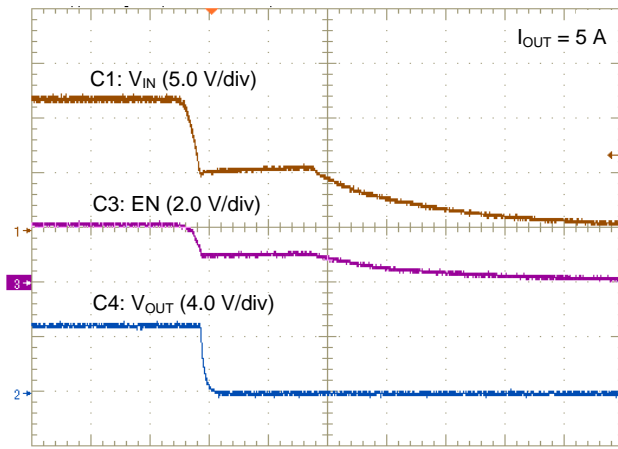

Figure 17. Prebias Start Up Relative to EN

2.9 Shutdown

The shutdown waveforms are shown in [Figure 18](#) and [Figure 19](#). The input voltage for these plots is 12 V with a 5-A resistive load. The top trace shows V_{IN} , the middle trace shows EN, and the bottom trace shows V_{OUT} . In [Figure 18](#) the input voltage is removed, and when the input falls below the undervoltage lockout threshold, the TPS54561 shuts down and the output falls to ground.

In [Figure 19](#), the input voltage is held at 12 V, and EN is shorted to ground. When EN is grounded, the TPS54561 is disabled, and the output voltage discharges to ground.



Time: 2.0 ms/div
Figure 18. Shutdown Relative to V_{IN}

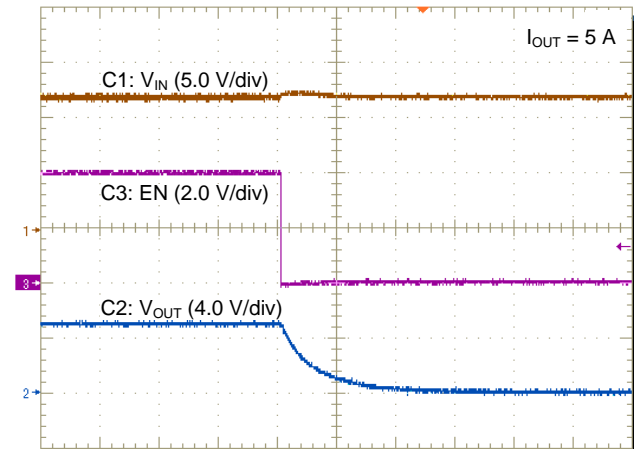

Time: 200 μ s/div
Figure 19. Shutdown Relative to EN

2.10 Low Dropout Operation

For improved low dropout operation, the TPS54561 includes a small integrated low-side MOSFET to pull SW to GND when the BOOT to SW voltage drops below 2.1 V. This recharges the BOOT capacitor for driving the high-side MOSFET. [Figure 20](#) shows the steady state operation and [Figure 21](#) shows the start up and shutdown in a low dropout condition. Both measurements are taken with a 5-V output.

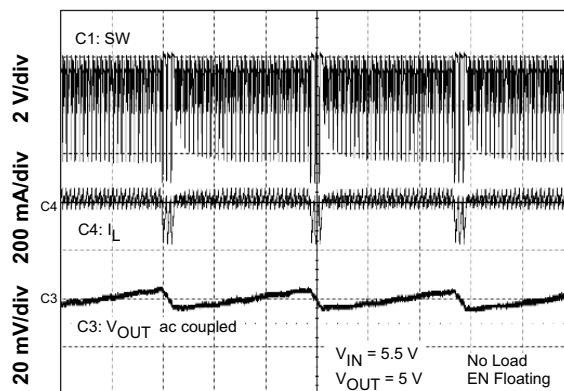

Time = 20 μ s/div
Figure 20. Low Dropout Operation

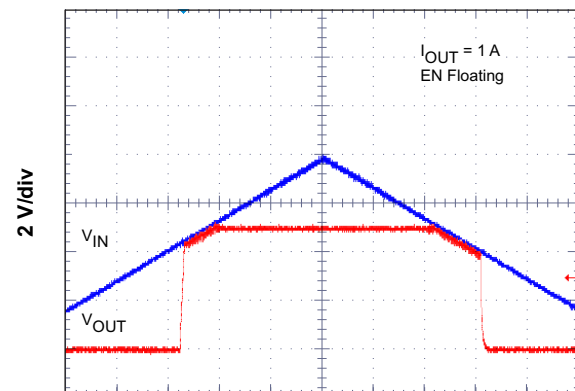

Time = 40 μ s/div
Figure 21. Low Dropout Start Up and Shutdown

3 Board Layout

This section provides a description of the EVM, board layout, and layer illustrations.

3.1 Layout

The board layout for the EVM is shown in [Figure 22](#) through [Figure 25](#). The top-side layer of the EVM is laid out in a manner typical of a user application. The top and bottom layers are 2-oz copper.

The top layer contains the main power traces for V_{IN} , V_{OUT} , and SW. Also on the top layer are connections for the remaining pins of the TPS54561 and a large area filled with ground. The bottom layer contains ground and a signal route for the bootstrap capacitor. The top and bottom and internal ground traces are connected with multiple vias placed around the board including six vias directly under the TPS54561 device to provide a thermal path from the top-side ground plane to the bottom-side ground plane.

The input decoupling capacitors (C1-C3, C10), bootstrap capacitor (C4), and frequency set resistor (R3) are all located as close to the IC as possible. In addition, the voltage set-point resistor divider components are also kept close to the IC. To reduce noise on the PWRGD signal, the PWRGD traces and pull up resistor (R8) is kept away from the switching node at the SW pin. The voltage divider network ties to the output voltage at the point of regulation, the copper V_{OUT} trace past the output connector (J1). For the TPS54561, an additional input bulk capacitor may be required (C11), depending on the EVM connection to the input supply.

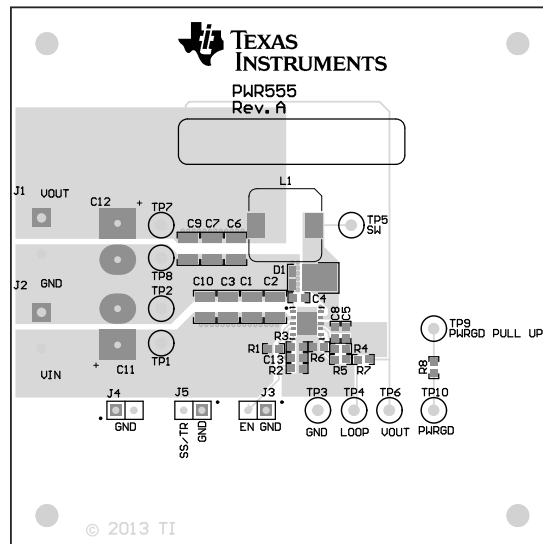

Figure 22. TPS54561EVM-555 Top Assembly and Silkscreen

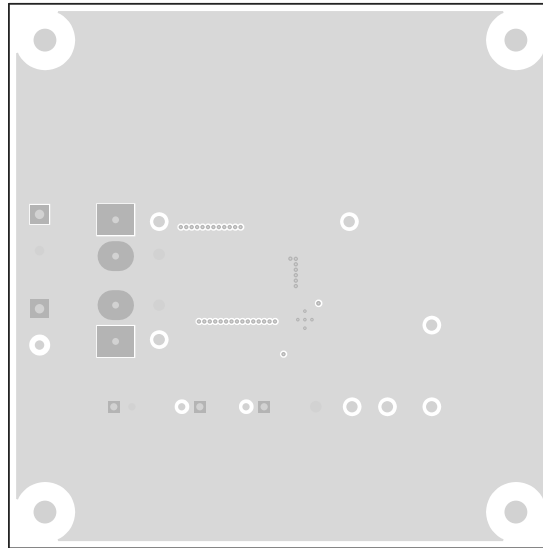

Figure 23. TPS54561EVM-555 Layer 2 Layout

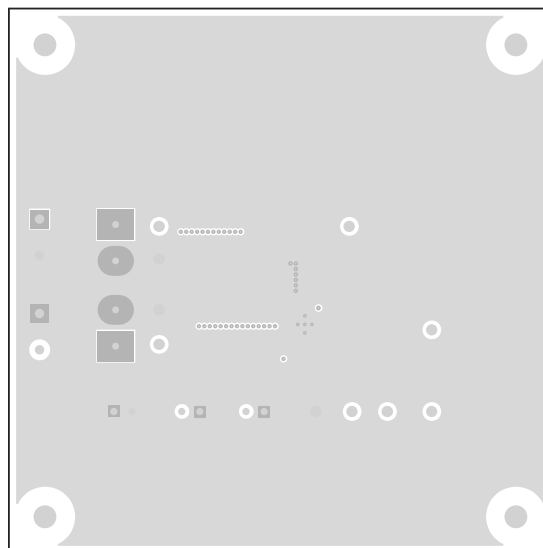

Figure 24. TPS54561EVM-555 Layer 3 Layout

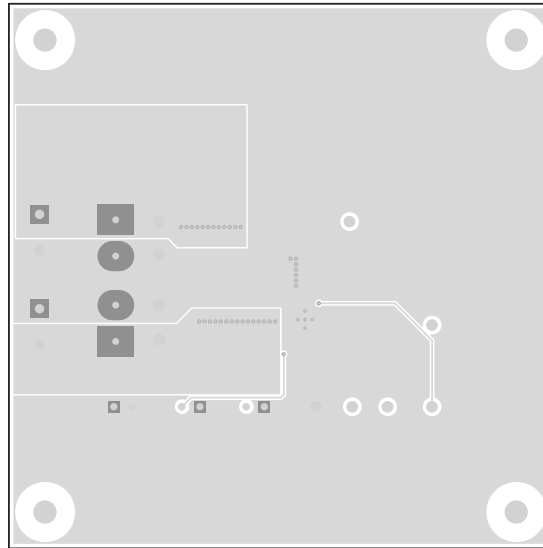

Figure 25. TPS54561EVM-555 Bottom-Side Layout

3.2 Estimated Circuit Area

The estimated PCB area for the components used in this design is 1.025 in² (661 mm²). This area does not include test points or connectors. This design uses 0603 components for easy modifications. The area can be reduced by using smaller-sized components.

4 Bill of Materials

Table 5 presents the bill of materials for the EVM.

Table 5. TPS54561EVM-555 Bill of Materials

Designator	Quantity	Value	Description	PackageReference	PartNumber	Manufacturer
PCB	1		Printed Circuit Board		PWR555	Any
C1, C2, C3, C10	4	2.2uF	CAP, CERM, 2.2uF, 100V, +/-10%, X7R, 1210	1210	GRM32ER72A225KA35L	MuRata
C4	1	0.1uF	CAP, CERM, 0.1uF, 10V, +/-10%, X7R, 0603	0603	STD	STD
C5	1	4700pF	CAP, CERM, 4700pF, 50V, +/-5%, X7R, 0603	0603	STD	STD
C6, C7, C9	3	47uF	CAP, CERM, 47uF, 16V, +/-20%, X5R, 1210	1210	GRM32ER61C476ME15L	MuRata
C8	1	47pF	CAP, CERM, 47pF, 50V, +/-5%, C0G/NP0, 0603	0603	STD	STD
C13	1	0.01uF	CAP, CERM, 0.01uF, 50V, +/-10%, X7R, 0603	0603	STD	STD
D1	1	60V	Diode, Schottky, 60V, 7A, PowerDI5	PowerDI5	PDS760-13	Diodes Inc.
J1, J2	2	ED120/2DS	Terminal Block, 2-pin, 15-A, 5.1mm	0.40 x 0.35 inch	ED120/2DS	OST
J3, J4, J5	3		Header, TH, 100mil, 2x1, Gold plated, 230 mil above insulator	TSW-102-07-G-S	TSW-102-07-G-S	Samtec, Inc.
L1	1	7.2uH	Inductor, Shielded, Metal Composite, 7.2uH, 6A, 0.0113 ohm, SMD	10.2 x 6.4 x 10.2mm	7447798720	Würth Elektronik eiSos
LBL1	1		Thermal Transfer Printable Labels, 1.250" W x 0.250" H - 10,000 per roll	PCB Label 1.25"H x 0.250"W	THT-13-457-10	Brady
R1	1	442k	RES, 442k ohm, 1%, 0.1W, 0603	0603	STD	STD
R2	1	90.9k	RES, 90.9k ohm, 1%, 0.1W, 0603	0603	STD	STD
R3	1	243k	RES, 243k ohm, 1%, 0.1W, 0603	0603	STD	STD
R4	1	16.9k	RES, 16.9k ohm, 1%, 0.1W, 0603	0603	STD	STD
R5	1	53.6k	RES, 53.6k ohm, 1%, 0.1W, 0603	0603	STD	STD
R6	1	10.2k	RES, 10.2k ohm, 1%, 0.1W, 0603	0603	STD	STD
R7	1	49.9	RES, 49.9 ohm, 1%, 0.1W, 0603	0603	STD	STD
R8	1	1.00k	RES, 1.00k ohm, 1%, 0.1W, 0603	0603	STD	STD
SH-J3	1	1x2	Shunt, 100mil, Gold plated, Black	Shunt	SNT-100-BK-G	Samtec
TP1, TP6, TP7, TP9	4	Red	Test Point, TH, Multipurpose, Red	Keystone5010	5010	Keystone
TP2, TP3, TP8	3	Black	Test Point, TH, Multipurpose, Black	Keystone5011	5011	Keystone
TP4	1	Orange	Test Point, TH, Multipurpose, Orange	Keystone5013	5013	Keystone
TP5, TP10	2	Yellow	Test Point, TH Multipurpose, Yellow	Keystone5014	5014	Keystone
U1	1	TPS54561DPR	60 V Input, 5 A, Step Down DC-DC Converter with Soft-Start and Eco-mode	DPR	TPS54561DPR	Texas Instruments
C11, C12	0	Open	Capacitor, Aluminum, 20%	Multi sizes	Engineering Only	Any

IMPORTANT NOTICE

Texas Instruments Incorporated and its subsidiaries (TI) reserve the right to make corrections, enhancements, improvements and other changes to its semiconductor products and services per JESD46, latest issue, and to discontinue any product or service per JESD48, latest issue. Buyers should obtain the latest relevant information before placing orders and should verify that such information is current and complete. All semiconductor products (also referred to herein as "components") are sold subject to TI's terms and conditions of sale supplied at the time of order acknowledgment.

TI warrants performance of its components to the specifications applicable at the time of sale, in accordance with the warranty in TI's terms and conditions of sale of semiconductor products. Testing and other quality control techniques are used to the extent TI deems necessary to support this warranty. Except where mandated by applicable law, testing of all parameters of each component is not necessarily performed.

TI assumes no liability for applications assistance or the design of Buyers' products. Buyers are responsible for their products and applications using TI components. To minimize the risks associated with Buyers' products and applications, Buyers should provide adequate design and operating safeguards.

TI does not warrant or represent that any license, either express or implied, is granted under any patent right, copyright, mask work right, or other intellectual property right relating to any combination, machine, or process in which TI components or services are used. Information published by TI regarding third-party products or services does not constitute a license to use such products or services or a warranty or endorsement thereof. Use of such information may require a license from a third party under the patents or other intellectual property of the third party, or a license from TI under the patents or other intellectual property of TI.

Reproduction of significant portions of TI information in TI data books or data sheets is permissible only if reproduction is without alteration and is accompanied by all associated warranties, conditions, limitations, and notices. TI is not responsible or liable for such altered documentation. Information of third parties may be subject to additional restrictions.

Resale of TI components or services with statements different from or beyond the parameters stated by TI for that component or service voids all express and any implied warranties for the associated TI component or service and is an unfair and deceptive business practice. TI is not responsible or liable for any such statements.

Buyer acknowledges and agrees that it is solely responsible for compliance with all legal, regulatory and safety-related requirements concerning its products, and any use of TI components in its applications, notwithstanding any applications-related information or support that may be provided by TI. Buyer represents and agrees that it has all the necessary expertise to create and implement safeguards which anticipate dangerous consequences of failures, monitor failures and their consequences, lessen the likelihood of failures that might cause harm and take appropriate remedial actions. Buyer will fully indemnify TI and its representatives against any damages arising out of the use of any TI components in safety-critical applications.

In some cases, TI components may be promoted specifically to facilitate safety-related applications. With such components, TI's goal is to help enable customers to design and create their own end-product solutions that meet applicable functional safety standards and requirements. Nonetheless, such components are subject to these terms.

No TI components are authorized for use in FDA Class III (or similar life-critical medical equipment) unless authorized officers of the parties have executed a special agreement specifically governing such use.

Only those TI components which TI has specifically designated as military grade or "enhanced plastic" are designed and intended for use in military/aerospace applications or environments. Buyer acknowledges and agrees that any military or aerospace use of TI components which have **not** been so designated is solely at the Buyer's risk, and that Buyer is solely responsible for compliance with all legal and regulatory requirements in connection with such use.

TI has specifically designated certain components as meeting ISO/TS16949 requirements, mainly for automotive use. In any case of use of non-designated products, TI will not be responsible for any failure to meet ISO/TS16949.

Products

Audio	www.ti.com/audio
Amplifiers	amplifier.ti.com
Data Converters	dataconverter.ti.com
DLP® Products	www.dlp.com
DSP	dsp.ti.com
Clocks and Timers	www.ti.com/clocks
Interface	interface.ti.com
Logic	logic.ti.com
Power Mgmt	power.ti.com
Microcontrollers	microcontroller.ti.com
RFID	www.ti-rfid.com
OMAP Applications Processors	www.ti.com/omap
Wireless Connectivity	www.ti.com/wirelessconnectivity

Applications

Automotive and Transportation	www.ti.com/automotive
Communications and Telecom	www.ti.com/communications
Computers and Peripherals	www.ti.com/computers
Consumer Electronics	www.ti.com/consumer-apps
Energy and Lighting	www.ti.com/energy
Industrial	www.ti.com/industrial
Medical	www.ti.com/medical
Security	www.ti.com/security
Space, Avionics and Defense	www.ti.com/space-avionics-defense
Video and Imaging	www.ti.com/video

TI E2E Community

e2e.ti.com