

TOSHIBA CMOS Linear Integrated Circuit Silicon Monolithic

# TCK2292xG, TCK2297xG

## 2A, 25mΩ Load Switch IC with Slew Rate Control Driver

The TCK2292xG and TCK2297xG are load switch ICs for power management with slew rate control driver featuring wide input voltage operation from 1.1 to 5.5 V. Switch ON resistance is only 25 mΩ typical at 5.0 V, -0.5 A load condition and these feature a slew rate control driver. TCK2292xG has output auto-discharge function. Output current type is available on 2 A.

These devices are available in 0.4 mm pitch ultra small package WCSP6E (0.8 mm x 1.2 mm, t: 0.55 mm). Thus they are ideal for portable applications that require high-density board assembly such as cellular phone.

### Feature

- Wide input voltage operation:  $V_{IN} = 1.1$  to 5.5 V
- Low ON resistance:
  - $R_{ON} = 25$  mΩ (typ.) at  $V_{IN} = 5.0$  V,  $I_{OUT} = -0.5$  A
  - $R_{ON} = 31$  mΩ (typ.) at  $V_{IN} = 3.3$  V,  $I_{OUT} = -0.5$  A
  - $R_{ON} = 52$  mΩ (typ.) at  $V_{IN} = 1.8$  V,  $I_{OUT} = -0.5$  A
  - $R_{ON} = 104$  mΩ (typ.) at  $V_{IN} = 1.2$  V,  $I_{OUT} = -0.5$  A
- Low Quiescent Current:  $I_Q = 0.1$  μA (typ.) at  $I_{OUT} = 0$  mA (TCK22921G, TCK22971G)
- Slew Rate Control circuit
- Output auto-discharge (Option)
- Reverse current blocking ( $V_{IN} = 0$  V)
- Pull down connection between Control and GND (Option)
- Ultra small package: WCSP6E (0.8mm x 1.2mm, t: 0.55mm)

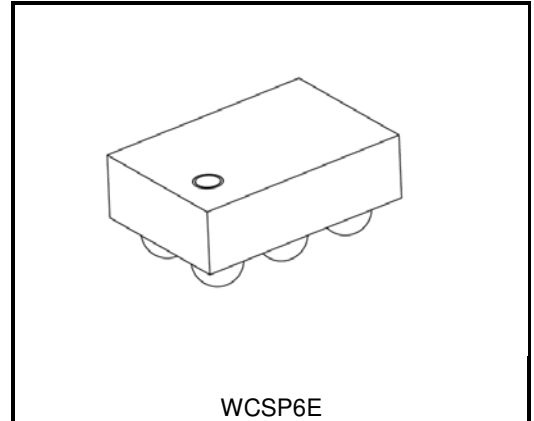

WCSP6E

Weight: 1 mg (typ.)

Start of commercial production  
2016-06

## Function Table

Part number	Function					Device Marking
	Rise time @VIN=5V	Reverse current blocking (VIN = 0 V)	Output auto-discharge	Control pin polarity	Control pin connection	
TCK22921G	4.5 μs	Built in	Built in	Active High	Pull down	1R
TCK22922G	666 μs	Built in	Built in	Active High	Pull down	2R
TCK22923G	1364 μs	Built in	Built in	Active High	Pull down	3R
TCK22925G	3380 μs	Built in	Built in	Active High	Pull down	4R
TCK22971G	4.5 μs	Built in	N/A	Active High	Pull down	5R
TCK22972G	666 μs	Built in	N/A	Active High	Pull down	6R
TCK22973G	1364 μs	Built in	N/A	Active High	Pull down	7R
TCK22974G	3380 μs	Built in	N/A	Active High	Pull down	8R
TCK22975G	666 μs	Built in	N/A	Active Low	Open	9R

## Absolute Maximum Ratings (Ta = 25°C)

Characteristics	Symbol	Rating		Unit
Input voltage	V <sub>IN</sub>	-0.3 to 6.0		V
Control voltage	V <sub>CT</sub>	-0.3 to 6.0		V
Output voltage	V <sub>OUT</sub>	-0.3 to 6.0		V
Output current	I <sub>OUT</sub>	DC	2.0	A
		Pulse	3.0 (Note1)	A
Power dissipation	P <sub>D</sub>	800 (Note 2)		mW
Operating temperature range	T <sub>opr</sub>	-40 to 85		°C
Junction temperature	T <sub>j</sub>	150		°C
Storage temperature	T <sub>stg</sub>	-55 to 150		°C

Note: Using continuously under heavy loads (e.g. the application of high temperature/current/voltage and the significant change in temperature, etc.) may cause this product to decrease in the reliability significantly even if the operating conditions (i.e. operating temperature/current/voltage, etc.) are within the absolute maximum ratings. Please design the appropriate reliability upon reviewing the Toshiba Semiconductor Reliability Handbook (“Handling Precautions”/“Derating Concept and Methods”) and individual reliability data (i.e. reliability test report and estimated failure rate, etc).

Note1: 100 μs pulse, 2% duty cycle

Note2: Rating at mounting on a board

Board material: Glass epoxy (FR4)

Board dimension: 40mm x 40mm (both sides of board), t=1.6mm

Metal pattern ratio: a surface approximately 50%, the reverse side approximately 50%

Through hole: diameter 0.5mm x 28

## Operating conditions

Characteristics	Symbol	Condition	Min	Max	Unit
Input voltage	V <sub>IN</sub>	—	1.1	5.5	V
Output voltage	V <sub>OUT</sub>	—	—	V <sub>IN</sub>	V
Output current	I <sub>OUT</sub>	1.4V < V <sub>IN</sub>	—	2.0	A
Control High-level input voltage	V <sub>IH</sub>	1.2V < V <sub>IN</sub> ≤ 5.5 V	1.0	—	V
		1.1V ≤ V <sub>IN</sub> ≤ 1.2 V	0.9	—	V
Control Low-level input voltage	V <sub>IL</sub>	—	—	0.4	V

## Pin Assignment(Top view)

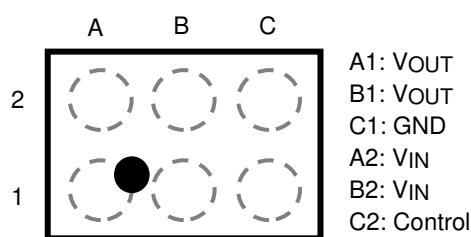

## Top marking

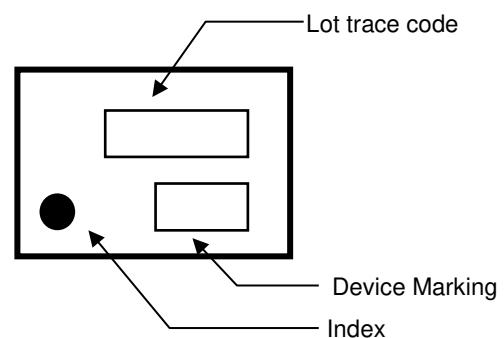



## Electrical Characteristics

### DC Characteristics (Ta = -40 to 85°C)

Characteristics	Symbol	Test Condition	Ta = 25°C			Ta = -40 to 85°C		Unit	
			Min	Typ.	Max	Min	Max		
Quiescent current ( ON state)	I <sub>Q</sub>	I <sub>OUT</sub> = 0 mA (Note 3)	V <sub>IN</sub> = 1.8 V	—	0.1	—	—	—	μA
			V <sub>IN</sub> = 3.3 V	—	0.1	—	—	—	μA
			V <sub>IN</sub> = 5.5 V	—	0.1	—	—	0.5	μA
Quiescent current ( ON state)	I <sub>Q</sub>	I <sub>OUT</sub> = 0 mA	V <sub>IN</sub> = 1.8 V	—	1.2	—	—	—	μA
			V <sub>IN</sub> = 3.3 V	—	1.3	—	—	—	μA
			V <sub>IN</sub> = 5.5 V	—	1.4	—	—	2.5	μA
Quiescent current ( OFF state)	I <sub>Q(OFF)</sub>	V <sub>IN</sub> = 5.5 V, V <sub>OUT</sub> = OPEN, (Note 4)	—	0.07	—	—	0.4	μA	
Switch leakage current( OFF state)	I <sub>SD(OFF)</sub>	V <sub>IN</sub> = 5.5 V, V <sub>OUT</sub> = GND, current through from V <sub>IN</sub> to V <sub>OUT</sub> . (Note 5)	—	0.02	—	—	2	μA	
Reverse blocking current	I <sub>RB</sub>	V <sub>OUT</sub> = 5.0 V, V <sub>IN</sub> = 0 V	—	0.01	—	—	2	μA	
On resistance	R <sub>ON</sub>	I <sub>OUT</sub> = -0.5 A	V <sub>IN</sub> = 5.0 V	—	25	—	—	43	mΩ
			V <sub>IN</sub> = 3.3 V	—	31	—	—	53	
			V <sub>IN</sub> = 1.8 V	—	52	—	—	83	
			V <sub>IN</sub> = 1.2 V	—	104	—	—	185	
			V <sub>IN</sub> = 1.1 V	—	136	—	—	—	
Output discharge on resistance	R <sub>SD</sub>	— (Note 6)	—	100	—	—	—	Ω	

Note 3: Only applies to the TCK22921G and TCK22971G

Note 4: Except OFF-state switch current

Note 5: Only applies to the TCK22971G, TCK22972G, TCK22973G, TCK22974G and TCK22975G

Note 6: Only applies to the TCK22921G, TCK22922G, TCK22923G, and TCK22925G

## AC Characteristics (Ta = 25°C)

V<sub>IN</sub> = 5.0 V

Characteristics	Symbol	Test Condition (Figure 1, Figure 2)	Min	Typ.	Max	Unit	
V <sub>OUT</sub> rise time	t <sub>r</sub>	R <sub>L</sub> = 5 Ω, C <sub>L</sub> = 1.0 μF	TCK22921G	—	4.5	—	μs
			TCK22971G	—	4.5	—	
			TCK22922G	—	666	—	
			TCK22972G	—	666	—	
			TCK22975G	—	666	—	
			TCK22923G	—	1364	—	
TCK22973G	—	1364	—				
TCK22925G	—	3380	—				
TCK22974G	—	3380	—				
V <sub>OUT</sub> fall time	t <sub>f</sub>	R <sub>L</sub> = 5 Ω, C <sub>L</sub> = 1.0 μF	—	10	—	μs	
Turn on delay	t <sub>ON</sub>	R <sub>L</sub> = 5 Ω, C <sub>L</sub> = 1.0 μF	TCK22921G	—	3	—	μs
			TCK22971G	—	3	—	
			TCK22922G	—	380	—	
			TCK22972G	—	380	—	
			TCK22975G	—	380	—	
			TCK22923G	—	750	—	
TCK22973G	—	750	—				
TCK22925G	—	2000	—				
TCK22974G	—	2000	—				
Turn off delay	t <sub>OFF</sub>	R <sub>L</sub> = 5 Ω, C <sub>L</sub> = 1.0 μF	—	10	—	μs	

## AC Waveform

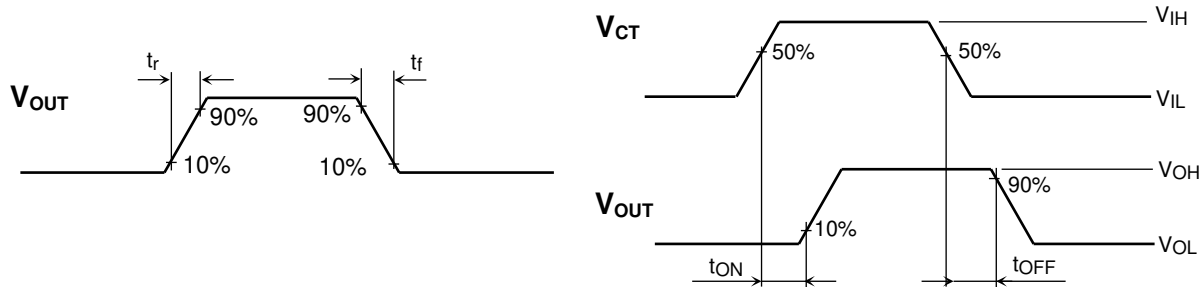

Figure 1 t<sub>r</sub>, t<sub>f</sub>, t<sub>ON</sub>, t<sub>OFF</sub> Waveforms(Active High)

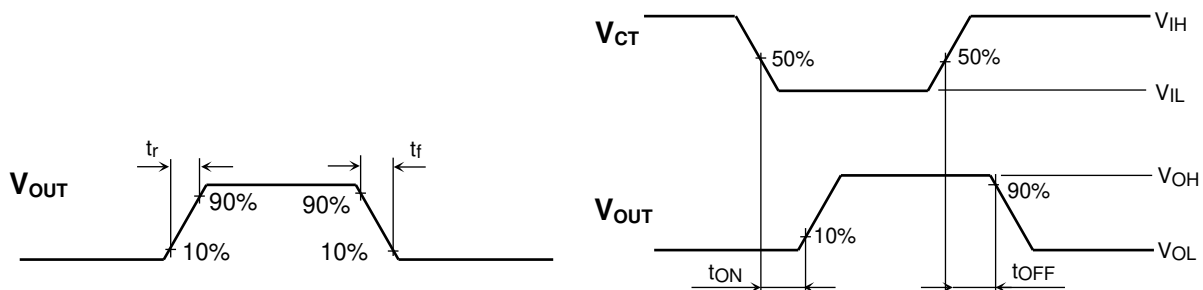
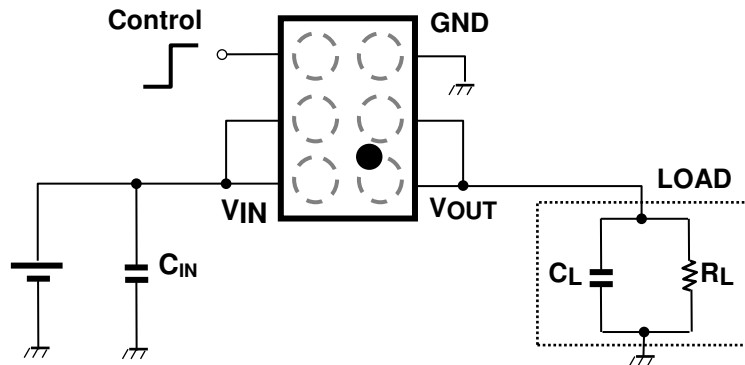

Figure 2 t<sub>r</sub>, t<sub>f</sub>, t<sub>ON</sub>, t<sub>OFF</sub> Waveforms(Active Low)

## Application Note

### 1. Application circuit example (top view)

The figure below shows the example of configuration



#### 1) Input capacitor

An input capacitor be sure to use  $C_{IN}$  for the stable operation. And it is effective to reduce voltage overshoot or undershoot due to sharp changes in output current and also for improved stability of the power supply. When used, place  $C_{IN}$  more than  $1.0\mu\text{F}$  as close to  $V_{IN}$  pin to improve stability of the power supply.

#### 2) Output capacitor

An output capacitor ( $C_{OUT}$ ) is not necessary for the guaranteed operation. However, there is a possibility of overshoot or undershoot caused by output load transient response, board layout and parasitic components of load switch IC. In this case, an output capacitor with  $C_{OUT}$  more than  $0.1\mu\text{F}$  is recommended.

#### 3) Control pin

The Control pin controls both the pass-through p-ch MOSFET and the discharge n-ch MOSFET (only for TCK2292xG), operated by the control voltage. Each control pin is equipped with Schmitt trigger. Also, pull down resistance equivalent to a few  $\text{M}\Omega$  is connected between Control and GND, thus the load switch IC is in OFF state even when Control pin is OPEN. (except TCK22975G). A control pin for TCK22975G is Active low and does not have a pull down resistor, please use be sure to fix the potential of the Control pin to High or Low.

### 2. Reverse current blocking

This device has a built-in Reverse current blocking (SW OFF state) circuit to block reverse current from  $V_{OUT}$  to  $V_{IN}$  when output p-ch MOSEFT turned off and input voltage is 0V.

### 3. Instructions and directions for use

This device has built-in several functions, but these do not assure for the suppression of uprising device operation. In use of these products, please read through and understand dissipation idea for absolute maximum ratings from the above mention or our 'Semiconductor Reliability Handbook'. Then use these products under absolute maximum ratings in any condition. Furthermore, Toshiba recommends inserting failsafe system into the design.

## 4. Power Dissipation

Power dissipation is measured on the board condition shown below.

[The Board Condition]

Board material: Glass epoxy (FR4)

Board dimension: 40mm x 40mm (both sides of board),  $t=1.6\text{mm}$

Metal pattern ratio: a surface approximately 50%, the reverse side approximately 50%

Through hole: diameter 0.5mm x 28

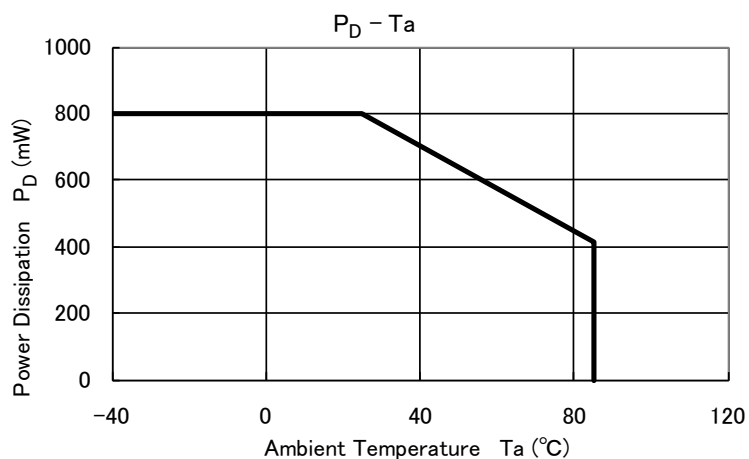

Please allow sufficient margin when designing a board pattern to fit the expected power dissipation. Also take into consideration the ambient temperature, input voltage, output current etc. and applying the appropriate derating for allowable power dissipation during operation.



## TCK2292xG, TCK2297xG Representative Typical Characteristics

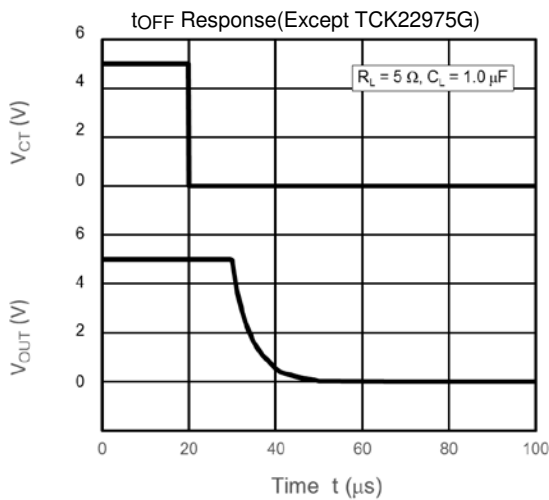
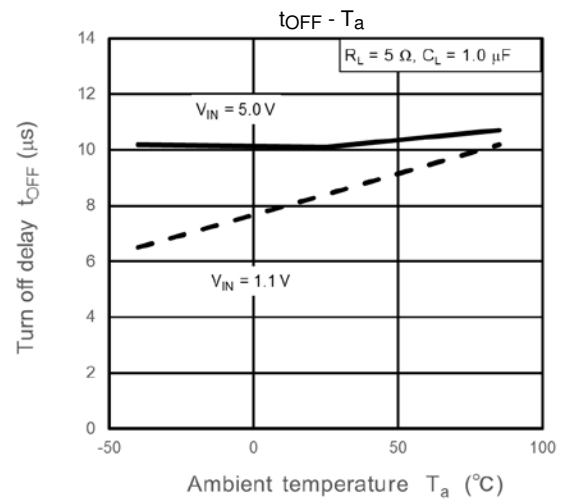
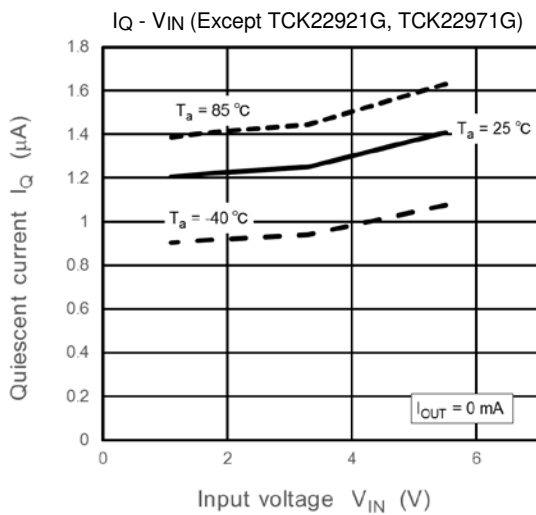
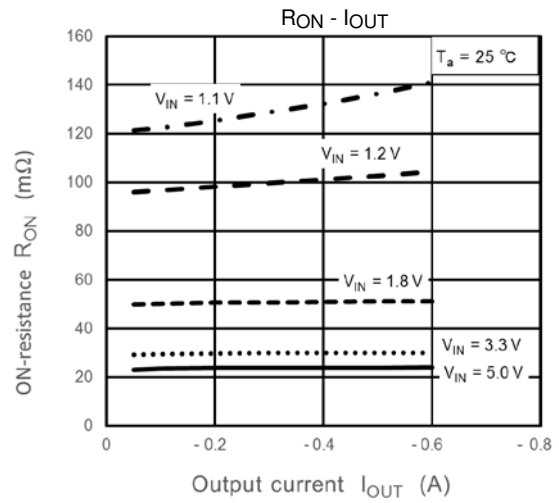
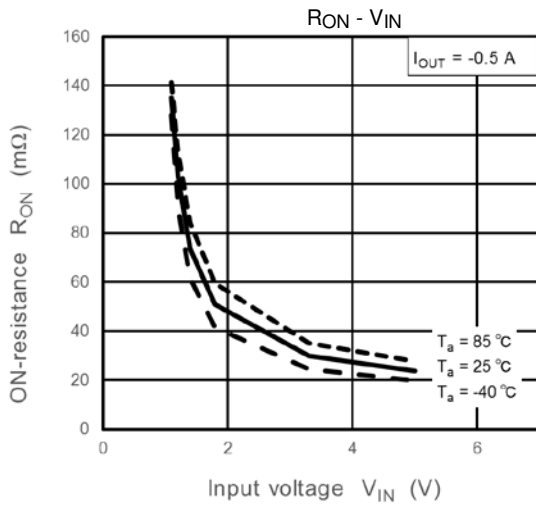

## TCK22921G, TCK22971G Representative Typical Characteristics

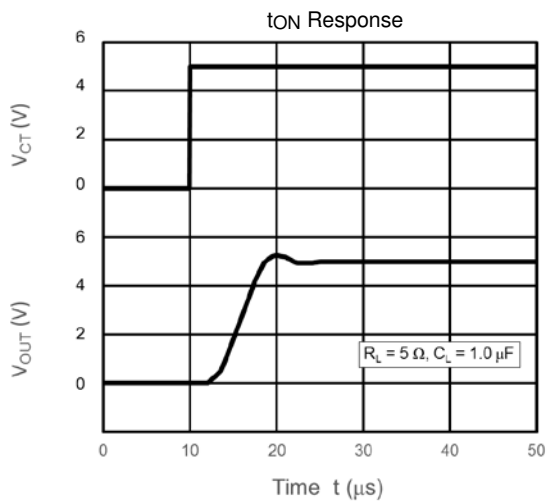
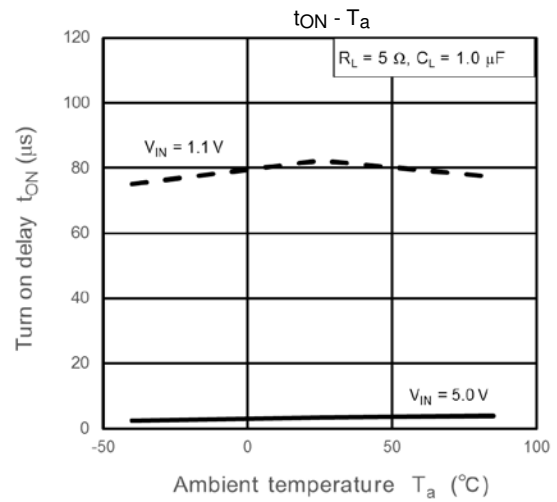
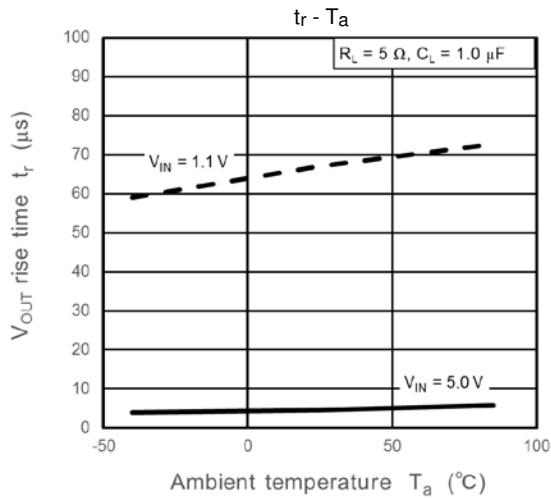

## TCK22922G, TCK22972G, TCK22975G Representative Typical Characteristics

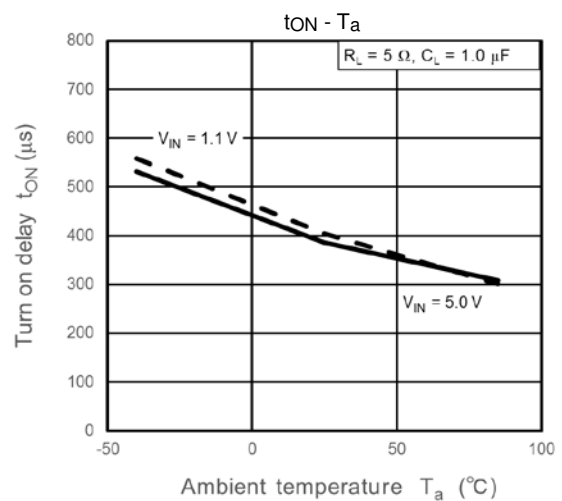
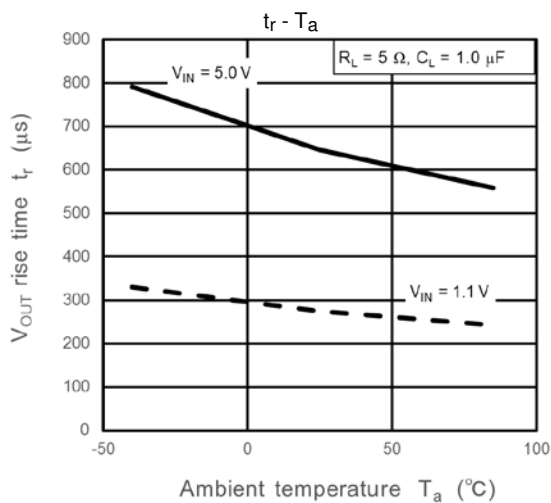

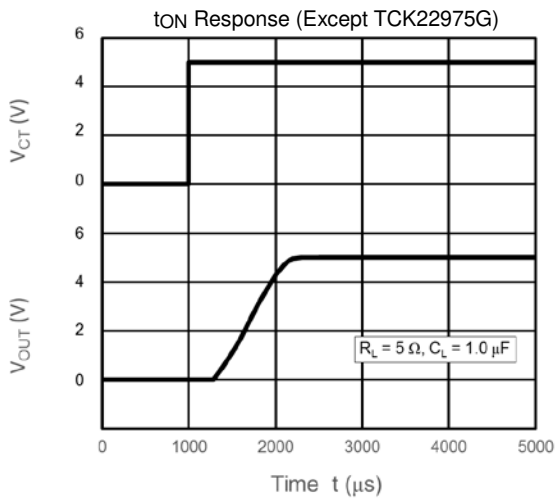

## TCK22923G, TCK22973G Representative Typical Characteristics

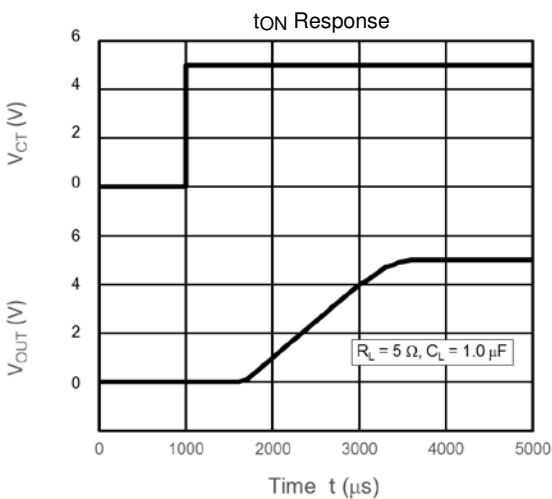
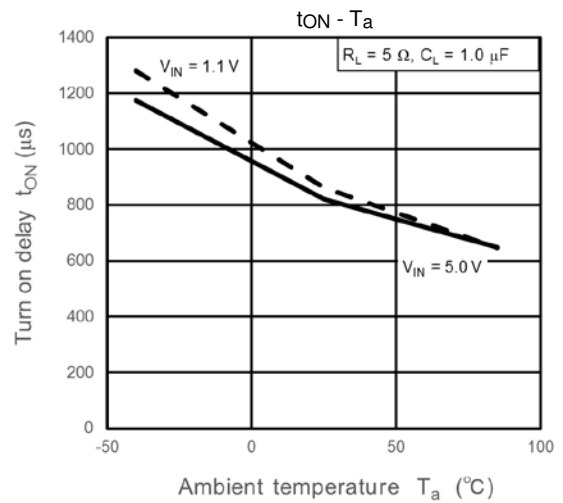
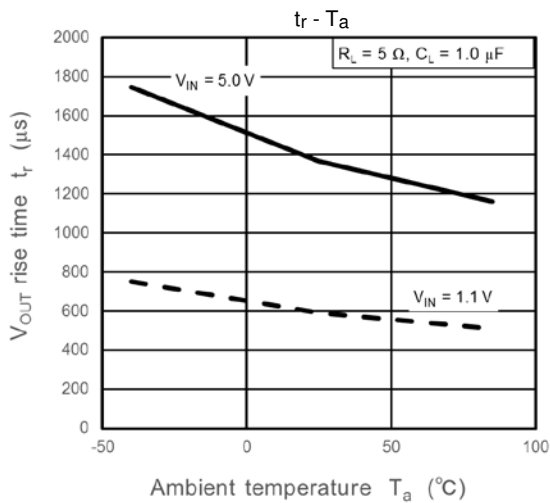

## TCK22925G, TCK22974G Representative Typical Characteristics

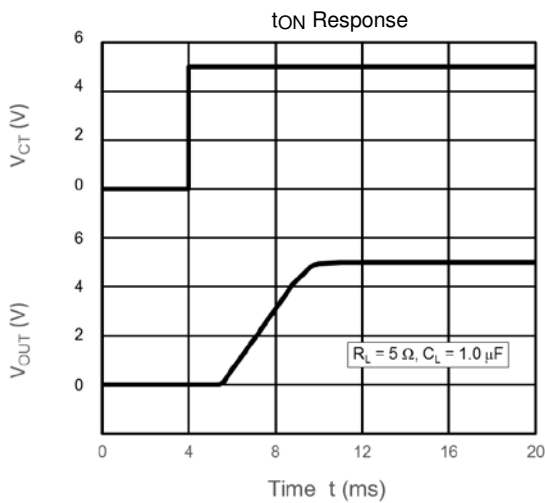
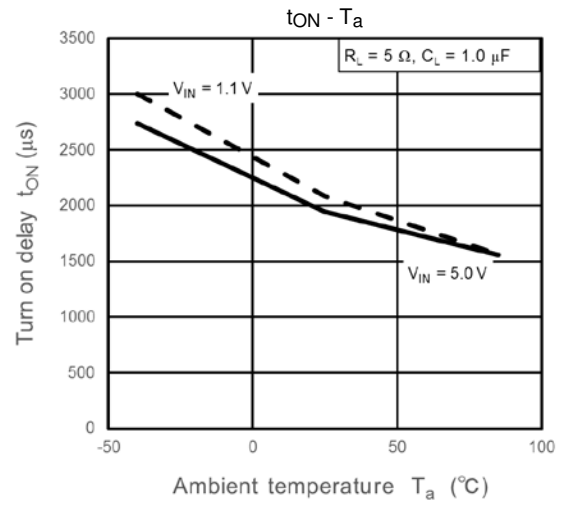
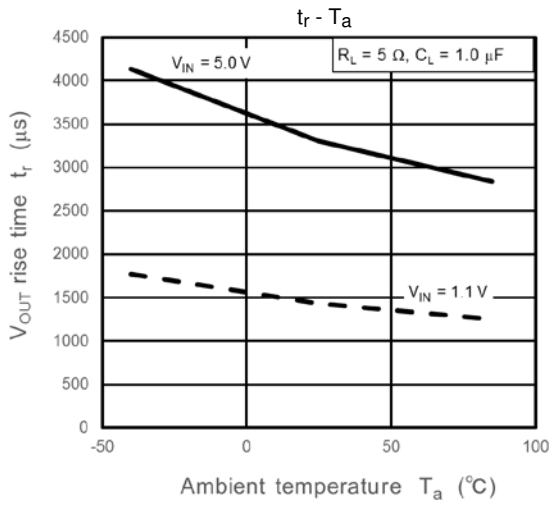

Note: The above characteristics curves are presented for reference only and not guaranteed by production test, unless otherwise noted.

## Package dimension

Unit: mm

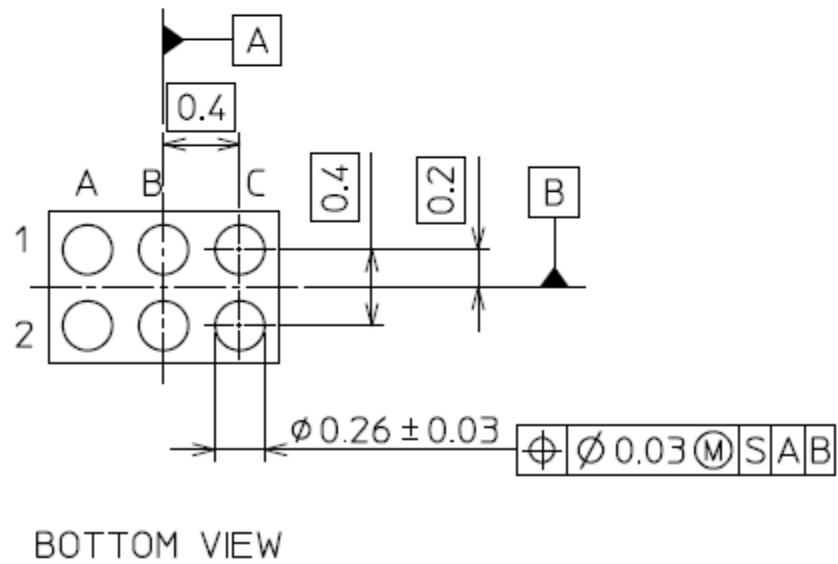
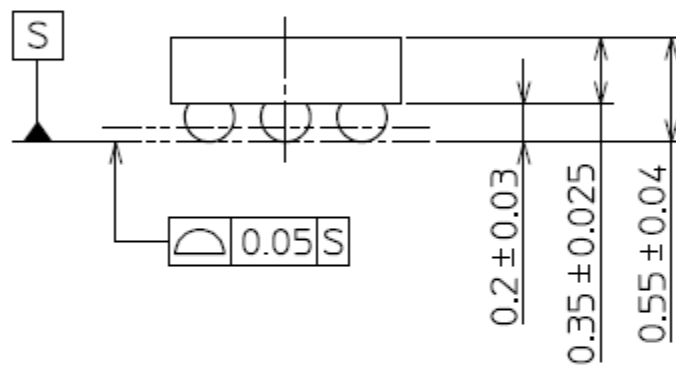
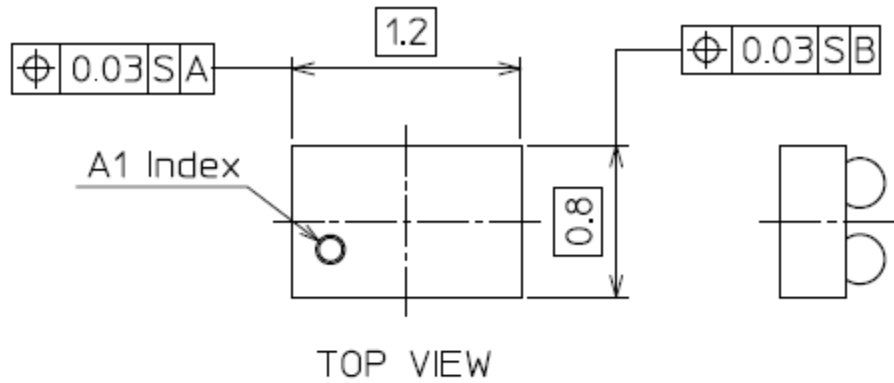

Weight: 1 mg (typ.)

Land pattern dimensions (for reference only)

Unit: mm

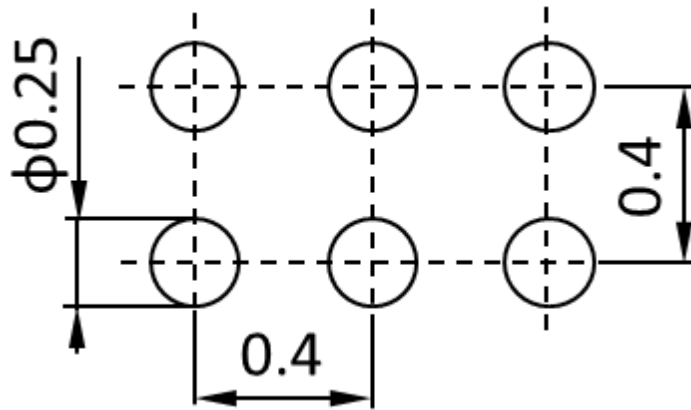

## RESTRICTIONS ON PRODUCT USE

Toshiba Corporation and its subsidiaries and affiliates are collectively referred to as "TOSHIBA". Hardware, software and systems described in this document are collectively referred to as "Product".

- TOSHIBA reserves the right to make changes to the information in this document and related Product without notice.
- This document and any information herein may not be reproduced without prior written permission from TOSHIBA. Even with TOSHIBA's written permission, reproduction is permissible only if reproduction is without alteration/omission.
- Though TOSHIBA works continually to improve Product's quality and reliability, Product can malfunction or fail. Customers are responsible for complying with safety standards and for providing adequate designs and safeguards for their hardware, software and systems which minimize risk and avoid situations in which a malfunction or failure of Product could cause loss of human life, bodily injury or damage to property, including data loss or corruption. Before customers use the Product, create designs including the Product, or incorporate the Product into their own applications, customers must also refer to and comply with (a) the latest versions of all relevant TOSHIBA information, including without limitation, this document, the specifications, the data sheets and application notes for Product and the precautions and conditions set forth in the "TOSHIBA Semiconductor Reliability Handbook" and (b) the instructions for the application with which the Product will be used with or for. Customers are solely responsible for all aspects of their own product design or applications, including but not limited to (a) determining the appropriateness of the use of this Product in such design or applications; (b) evaluating and determining the applicability of any information contained in this document, or in charts, diagrams, programs, algorithms, sample application circuits, or any other referenced documents; and (c) validating all operating parameters for such designs and applications. **TOSHIBA ASSUMES NO LIABILITY FOR CUSTOMERS' PRODUCT DESIGN OR APPLICATIONS.**
- **PRODUCT IS NEITHER INTENDED NOR WARRANTED FOR USE IN EQUIPMENTS OR SYSTEMS THAT REQUIRE EXTRAORDINARILY HIGH LEVELS OF QUALITY AND/OR RELIABILITY, AND/OR A MALFUNCTION OR FAILURE OF WHICH MAY CAUSE LOSS OF HUMAN LIFE, BODILY INJURY, SERIOUS PROPERTY DAMAGE AND/OR SERIOUS PUBLIC IMPACT ("UNINTENDED USE").** Except for specific applications as expressly stated in this document, Unintended Use includes, without limitation, equipment used in nuclear facilities, equipment used in the aerospace industry, lifesaving and/or life supporting medical equipment, equipment used for automobiles, trains, ships and other transportation, traffic signaling equipment, equipment used to control combustions or explosions, safety devices, elevators and escalators, and devices related to power plant. **IF YOU USE PRODUCT FOR UNINTENDED USE, TOSHIBA ASSUMES NO LIABILITY FOR PRODUCT.** For details, please contact your TOSHIBA sales representative or contact us via our website.
- Do not disassemble, analyze, reverse-engineer, alter, modify, translate or copy Product, whether in whole or in part.
- Product shall not be used for or incorporated into any products or systems whose manufacture, use, or sale is prohibited under any applicable laws or regulations.
- The information contained herein is presented only as guidance for Product use. No responsibility is assumed by TOSHIBA for any infringement of patents or any other intellectual property rights of third parties that may result from the use of Product. No license to any intellectual property right is granted by this document, whether express or implied, by estoppel or otherwise.
- **ABSENT A WRITTEN SIGNED AGREEMENT, EXCEPT AS PROVIDED IN THE RELEVANT TERMS AND CONDITIONS OF SALE FOR PRODUCT, AND TO THE MAXIMUM EXTENT ALLOWABLE BY LAW, TOSHIBA (1) ASSUMES NO LIABILITY WHATSOEVER, INCLUDING WITHOUT LIMITATION, INDIRECT, CONSEQUENTIAL, SPECIAL, OR INCIDENTAL DAMAGES OR LOSS, INCLUDING WITHOUT LIMITATION, LOSS OF PROFITS, LOSS OF OPPORTUNITIES, BUSINESS INTERRUPTION AND LOSS OF DATA, AND (2) DISCLAIMS ANY AND ALL EXPRESS OR IMPLIED WARRANTIES AND CONDITIONS RELATED TO SALE, USE OF PRODUCT, OR INFORMATION, INCLUDING WARRANTIES OR CONDITIONS OF MERCHANTABILITY, FITNESS FOR A PARTICULAR PURPOSE, ACCURACY OF INFORMATION, OR NONINFRINGEMENT.**
- Do not use or otherwise make available Product or related software or technology for any military purposes, including without limitation, for the design, development, use, stockpiling or manufacturing of nuclear, chemical, or biological weapons or missile technology products (mass destruction weapons). Product and related software and technology may be controlled under the applicable export laws and regulations including, without limitation, the Japanese Foreign Exchange and Foreign Trade Law and the U.S. Export Administration Regulations. Export and re-export of Product or related software or technology are strictly prohibited except in compliance with all applicable export laws and regulations.
- Please contact your TOSHIBA sales representative for details as to environmental matters such as the RoHS compatibility of Product. Please use Product in compliance with all applicable laws and regulations that regulate the inclusion or use of controlled substances, including without limitation, the EU RoHS Directive. **TOSHIBA ASSUMES NO LIABILITY FOR DAMAGES OR LOSSES OCCURRING AS A RESULT OF NONCOMPLIANCE WITH APPLICABLE LAWS AND REGULATIONS.**