

AMC1411-Q1 Automotive, High-Impedance, 2-V Input, Reinforced Isolated Amplifier in a 15-mm Stretched SOIC Package

1 Features

- AEC-Q100 qualified for automotive applications:
 - Temperature grade 1: -40°C to $+125^{\circ}\text{C}$, T_A
- **Functional Safety-Capable**
 - [Documentation available to aid functional safety system design](#)
- 2-V, high-impedance input voltage range optimized for isolated voltage measurements
- Fixed gain: 1.0 V/V
- Low DC errors:
 - Offset error ± 1.5 mV (max)
 - Offset drift: ± 10 $\mu\text{V}/^{\circ}\text{C}$ (max)
 - Gain error: $\pm 0.2\%$ (max)
 - Gain drift: ± 30 ppm/ $^{\circ}\text{C}$ (max)
 - Nonlinearity 0.04% (max)
- 3.3-V or 5-V operation on high-side and low-side
- Missing high-side supply detection feature
- High CMTI: 100 kV/ μs (min)
- ≥ 15.7 -mm creepage, stretched SOIC package
- Reinforced isolation:
 - 10600- V_{PK} reinforced isolation per DIN VDE V 0884-11: 2017-01
 - 7500- V_{RMS} isolation for 1 minute per UL1577

2 Applications

- Isolated voltage sensing in:
 - [Traction inverters](#)
 - [Onboard chargers](#)
 - [DC/DC converters](#)
 - [HEV/EV DC chargers](#)

3 Description

The AMC1411-Q1 is a precision, isolated amplifier with an output separated from the input circuitry by a capacitive isolation barrier that is highly resistant to magnetic interference. This barrier is certified to provide reinforced galvanic isolation of up to 7.5 kV_{RMS} according to VDE V 0884-11 and UL1577 and supports a working voltage of up to 1600 V_{RMS}.

The isolation barrier separates parts of the system that operate on different common-mode voltage levels and protects the low-voltage side from voltages that can cause electrical damage or be harmful to an operator.

The high-impedance input of the AMC1411-Q1 is optimized for connection to high-impedance resistive dividers or other high-impedance voltage signal source. The excellent DC accuracy and low temperature drift support accurate, isolated voltage sensing in onboard chargers (OBC), DC/DC converters, traction inverters, or other applications that must operate at high common-mode voltages, high altitudes, or in environments with high pollution degrees.

The AMC1411-Q1 is offered in a stretched 8-pin SOIC package and is AEC-Q100 qualified for automotive applications and supports the temperature range from -40°C to $+125^{\circ}\text{C}$.

Device Information⁽¹⁾

PART NUMBER	PACKAGE	BODY SIZE (NOM)
AMC1411-Q1	SOIC (8)	6.4 mm × 14.0 mm

(1) For all available packages, see the orderable addendum at the end of the data sheet.

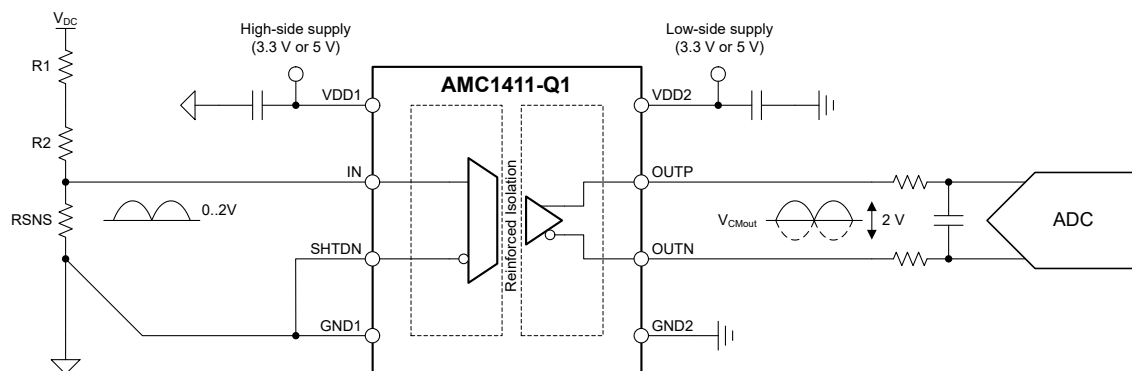

Typical Application

Table of Contents

1 Features	1	7.2 Functional Block Diagram.....	18
2 Applications	1	7.3 Feature Description.....	18
3 Description	1	7.4 Device Functional Modes.....	20
4 Revision History	2	8 Application and Implementation	21
5 Pin Configuration and Functions	3	8.1 Application Information.....	21
6 Specifications	4	8.2 Typical Application.....	21
6.1 Absolute Maximum Ratings	4	8.3 What To Do and What Not To Do.....	25
6.2 ESD Ratings	4	9 Power Supply Recommendations	25
6.3 Recommended Operating Conditions	4	10 Layout	26
6.4 Thermal Information	5	10.1 Layout Guidelines.....	26
6.5 Power Ratings	5	10.2 Layout Example.....	26
6.6 Insulation Specifications	6	11 Device and Documentation Support	27
6.7 Safety-Related Certifications	7	11.1 Documentation Support.....	27
6.8 Safety Limiting Values	7	11.2 Receiving Notification of Documentation Updates..	27
6.9 Electrical Characteristics	8	11.3 Support Resources.....	27
6.10 Switching Characteristics	10	11.4 Trademarks.....	27
6.11 Timing Diagram.....	10	11.5 Electrostatic Discharge Caution.....	27
6.12 Insulation Characteristics Curves.....	11	11.6 Glossary.....	27
6.13 Typical Characteristics.....	12	12 Mechanical, Packaging, and Orderable Information	27
7 Detailed Description	18		
7.1 Overview.....	18		

4 Revision History

NOTE: Page numbers for previous revisions may differ from page numbers in the current version.

DATE	REVISION	NOTES
October 2021	*	Initial Release

5 Pin Configuration and Functions

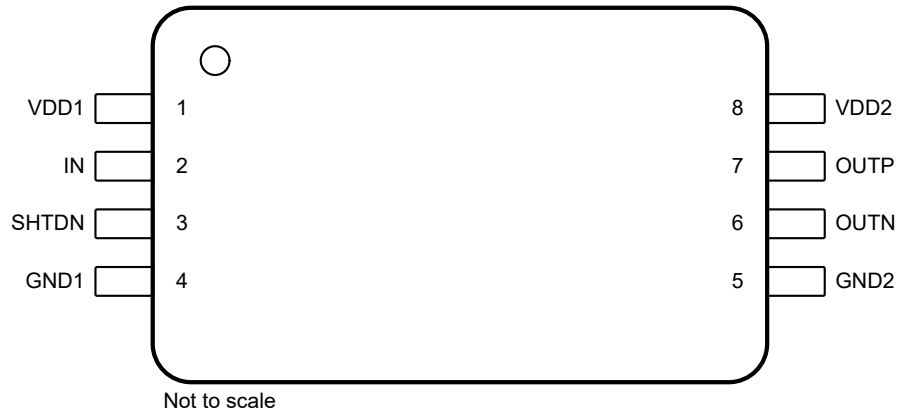

Figure 5-1. DWL Package, 8-Pin SOIC (Top View)

Table 5-1. Pin Functions

PIN		TYPE	DESCRIPTION
NO.	NAME		
1	VDD1	High-side power	High-side power supply ⁽¹⁾
2	INP	Analog input	Analog input
3	SHTDN	Digital input	Shutdown input, active high, with internal pullup resistor (typical value: 100 kΩ)
4	GND1	High-side ground	High-side analog ground
5	GND2	Low-side ground	Low-side analog ground
6	OUTN	Analog output	Inverting analog output
7	OUTP	Analog output	Noninverting analog output
8	VDD2	Low-side power	Low-side power supply ⁽¹⁾

(1) See the [Power Supply Recommendations](#) section for power-supply decoupling recommendations.

6 Specifications

6.1 Absolute Maximum Ratings

see⁽¹⁾

		MIN	MAX	UNIT
Power-supply voltage	High-side VDD1 to GND1	-0.3	6.5	V
	Low-side VDD2 to GND2	-0.3	6.5	
Input voltage	IN	GND1 - 6	VDD1 + 0.5	V
	SHTDN	GND1 - 0.5	VDD1 + 0.5	
Output voltage	OUTP, OUTN	GND2 - 0.5	VDD2 + 0.5	V
Input current	Continuous, any pin except power-supply pins	-10	10	mA
Temperature	Junction, T _J		150	°C
	Storage, T _{stg}	-65	150	

- (1) Operation outside the *Absolute Maximum Ratings* may cause permanent device damage. *Absolute Maximum Ratings* do not imply functional operation of the device at these or any other conditions beyond those listed under *Recommended Operating Conditions*. If used outside the Recommended Operating Conditions but within the Absolute Maximum Ratings, the device may not be fully functional, and this may affect device reliability, functionality, performance, and shorten the device lifetime.

6.2 ESD Ratings

			VALUE	UNIT
V _(ESD)	Electrostatic discharge	Human-body model (HBM), per AEC Q100-002 ⁽¹⁾ , HBM ESD classification Level 2	±2000	V
		Charged-device model (CDM), per AEC Q100-011, CDM ESD classification Level C6	±1000	

- (1) AEC Q100-002 indicates that HBM stressing shall be in accordance with the ANSI/ESDA/JEDEC JS-001 specification.

6.3 Recommended Operating Conditions

over operating ambient temperature range (unless otherwise noted)

			MIN	NOM	MAX	UNIT
POWER SUPPLY						
	High-side power supply	VDD1 to GND1	3	5	5.5	V
	Low-side power supply	VDD2 to GND2	3	3.3	5.5	V
ANALOG INPUT						
V _{Clipping}	Input voltage before clipping output	IN to GND1	2.516			V
V _{FSR}	Specified linear full-scale voltage	IN to GND1	-0.1	2		V
DIGITAL INPUT						
	Input voltage	SHTDN to GND1	0	VDD1		V
TEMPERATURE RANGE						
T _A	Specified ambient temperature		-40	125		°C

6.4 Thermal Information

THERMAL METRIC ⁽¹⁾		AMC1411-Q1	UNIT
		DWL (SOIC)	
		8 PINS	
R _{θJA}	Junction-to-ambient thermal resistance	63.2	°C/W
R _{θJC(top)}	Junction-to-case (top) thermal resistance	26.1	°C/W
R _{θJB}	Junction-to-board thermal resistance	28.5	°C/W
ψ _{JT}	Junction-to-top characterization parameter	7.8	°C/W
ψ _{JB}	Junction-to-board characterization parameter	26.8	°C/W
R _{θJC(bot)}	Junction-to-case (bottom) thermal resistance	n/a	°C/W

(1) For more information about traditional and new thermal metrics, see the [Semiconductor and IC Package Thermal Metrics](#) application report.

6.5 Power Ratings

PARAMETER		TEST CONDITIONS	VALUE	UNIT
P _D	Maximum power dissipation (both sides)	VDD1 = VDD2 = 3.6 V	56	mW
		VDD1 = VDD2 = 5.5 V	98	
P _{D1}	Maximum power dissipation (high-side)	VDD1 = 3.6 V	30	mW
		VDD1 = 5.5 V	53	
P _{D2}	Maximum power dissipation (low-side)	VDD2 = 3.6 V	26	mW
		VDD2 = 5.5 V	45	

6.6 Insulation Specifications

over operating ambient temperature range (unless otherwise noted)

PARAMETER		TEST CONDITIONS	VALUE	UNIT
GENERAL				
CLR	External clearance ⁽¹⁾	Shortest pin-to-pin distance through air	≥ 14.7	mm
CPG	External creepage ⁽¹⁾	Shortest pin-to-pin distance across the package surface	≥ 15.7	mm
DTI	Distance through insulation	Minimum internal gap (internal clearance) of the double insulation	≥ 0.021	mm
CTI	Comparative tracking index	DIN EN 60112 (VDE 0303-11); IEC 60112	≥ 600	V
	Material group	According to IEC 60664-1	I	
	Overvoltage category per IEC 60664-1	Rated mains voltage ≤ 600 V _{RMS}	I-IV	
		Rated mains voltage ≤ 1000 V _{RMS}	I-III	
DIN VDE V 0884-11 (VDE V 0884-11): 2017-01				
V _{IORM}	Maximum repetitive peak isolation voltage	At AC voltage	2260	V _{PK}
V _{IOWM}	Maximum-rated isolation working voltage	At AC voltage (sine wave)	1600	V _{RMS}
		At DC voltage	2260	V _{DC}
V _{IOTM}	Maximum transient isolation voltage	V _{TEST} = V _{IOTM} , t = 60 s (qualification test)	10600	V _{PK}
		V _{TEST} = 1.2 × V _{IOTM} , t = 1 s (100% production test)	12720	
V _{IOSM}	Maximum surge isolation voltage ⁽²⁾	Test method per IEC 60065, 1.2/50-μs waveform, V _{TEST} = 1.6 × V _{IOSM} = 12800 V _{PK} (qualification)	8000	V _{PK}
q _{pd}	Apparent charge ⁽³⁾	Method a, after input/output safety test subgroups 2 and 3, V _{ini} = V _{IOTM} , t _{ini} = 60 s, V _{pd(m)} = 1.2 × V _{IORM} , t _m = 10 s	≤ 5	pC
		Method a, after environmental tests subgroup 1, V _{ini} = V _{IOTM} , t _{ini} = 60 s, V _{pd(m)} = 1.6 × V _{IORM} , t _m = 10 s	≤ 5	
		Method b1, at routine test (100% production) and preconditioning (type test), V _{ini} = V _{IOTM} , t _{ini} = 1 s, V _{pd(m)} = 1.875 × V _{IORM} , t _m = 1 s	≤ 5	
C _{IO}	Barrier capacitance, input to output ⁽⁴⁾	V _{IO} = 0.5 V _{PP} at 1 MHz	~1.5	pF
R _{IO}	Insulation resistance, input to output ⁽⁴⁾	V _{IO} = 500 V at T _A = 25°C	> 10 ¹²	Ω
		V _{IO} = 500 V at 100°C ≤ T _A ≤ 125°C	> 10 ¹¹	
		V _{IO} = 500 V at T _S = 150°C	> 10 ⁹	
	Pollution degree		2	
	Climatic category		55/125/21	
UL1577				
V _{ISO}	Withstand isolation voltage	V _{TEST} = V _{ISO} = 7500 V _{RMS} or 10600 V _{DC} , t = 60 s (qualification), V _{TEST} = 1.2 × V _{ISO} = 9000 V _{RMS} , t = 1 s (100% production test)	7500	V _{RMS}

- (1) Apply creepage and clearance requirements according to the specific equipment isolation standards of an application. Care must be taken to maintain the creepage and clearance distance of a board design to ensure that the mounting pads of the isolator on the printed circuit board (PCB) do not reduce this distance. Creepage and clearance on a PCB become equal in certain cases. Techniques such as inserting grooves, ribs, or both on a PCB are used to help increase these specifications.
- (2) Testing is carried out in air or oil to determine the intrinsic surge immunity of the isolation barrier.
- (3) Apparent charge is electrical discharge caused by a partial discharge (pd).
- (4) All pins on each side of the barrier are tied together, creating a two-pin device.

6.7 Safety-Related Certifications

VDE	UL
Certified according to DIN VDE V 0884-11 (VDE V 0884-11): 2017-01, DIN EN 60950-1 (VDE 0805 Teil 1): 2014-08, and DIN EN 60065 (VDE 0860): 2005-11	Recognized under 1577 component recognition and CSA component acceptance NO 5 programs
Reinforced insulation	Single protection
Certificate number: pending	File number: E181974

6.8 Safety Limiting Values

Safety limiting⁽¹⁾ intends to minimize potential damage to the isolation barrier upon failure of input or output circuitry. A failure of the I/O can allow low resistance to ground or the supply and, without current limiting, dissipate sufficient power to over-heat the die and damage the isolation barrier potentially leading to secondary system failures.

PARAMETER		TEST CONDITIONS	MIN	TYP	MAX	UNIT
I _S	Safety input, output, or supply current	R _{θJA} = 63.2°C/W, VDDx = 3.6 V, T _J = 150°C, T _A = 25°C			550	mA
		R _{θJA} = 63.2°C/W, VDDx = 5.5 V, T _J = 150°C, T _A = 25°C			360	
P _S	Safety input, output, or total power	R _{θJA} = 63.2°C/W, T _J = 150°C, T _A = 25°C			1980	mW
T _S	Maximum safety temperature				150	°C

- (1) The maximum safety temperature, T_S, has the same value as the maximum junction temperature, T_J, specified for the device. The I_S and P_S parameters represent the safety current and safety power, respectively. Do not exceed the maximum limits of I_S and P_S. These limits vary with the ambient temperature, T_A.

The junction-to-air thermal resistance, R_{θJA}, in the [Thermal Information](#) table is that of a device installed on a high-K test board for leaded surface-mount packages. Use these equations to calculate the value for each parameter:

$T_J = T_A + R_{\theta JA} \times P$, where P is the power dissipated in the device.

$T_{J(max)} = T_S = T_A + R_{\theta JA} \times P_S$, where T_{J(max)} is the maximum junction temperature.

$P_S = I_S \times VDD_{max}$, where VDD_{max} is the maximum supply voltage for high-side and low-side.

6.9 Electrical Characteristics

minimum and maximum specifications apply from $T_A = -40^{\circ}\text{C}$ to $+125^{\circ}\text{C}$, $V_{DD1} = 3.0\text{ V}$ to 5.5 V , $V_{DD2} = 3.0\text{ V}$ to 5.5 V , $V_{IN} = -0.1\text{ V}$ to 2 V , and $\text{SHTDN} = \text{GND1} = 0\text{ V}$ (unless otherwise noted); typical specifications are at $T_A = 25^{\circ}\text{C}$, $V_{DD1} = 5\text{ V}$, and $V_{DD2} = 3.3\text{ V}$

PARAMETER		TEST CONDITIONS	MIN	TYP	MAX	UNIT
ANALOG INPUT						
V_{OS}	Input offset voltage	$T_A = 25^{\circ}\text{C}^{(1) (2)}$	-1.5	± 0.1	1.5	mV
TCV_{OS}	Input offset thermal drift ^{(1) (2) (4)}		-10	± 3	10	$\mu\text{V}/^{\circ}\text{C}$
R_{IN}	Input resistance	$T_A = 25^{\circ}\text{C}$		1		G Ω
I_{IB}	Input bias current	$\text{IN} = \text{GND1}$, $T_A = 25^{\circ}\text{C}$	-15	3.5	15	nA
C_{IN}	Input capacitance	$f_{IN} = 275\text{ kHz}$		7		pF
ANALOG OUTPUT						
	Nominal gain			1		V/V
E_G	Gain error ⁽¹⁾	$T_A = 25^{\circ}\text{C}$	-0.2	± 0.05	0.2	%
TCE_G	Gain error drift ^{(1) (5)}		-30	± 5	30	ppm/ $^{\circ}\text{C}$
	Nonlinearity ⁽¹⁾		-0.04%	$\pm 0.01\%$	0.04%	
THD	Total harmonic distortion ⁽³⁾	$V_{IN} = 2 V_{PP}$, $V_{IN} > 0\text{ V}$, $f_{IN} = 10\text{ kHz}$, $\text{BW} = 10\text{ kHz}$		-87		dB
SNR	Signal-to-noise ratio	$V_{IN} = 2 V_{PP}$, $f_{IN} = 1\text{ kHz}$, $\text{BW} = 10\text{ kHz}$	79	82.6		dB
		$V_{IN} = 2 V_{PP}$, $f_{IN} = 10\text{ kHz}$, $\text{BW} = 100\text{ kHz}$		70.9		
	Output noise	$V_{IN} = \text{GND1}$, $\text{BW} = 100\text{ kHz}$		220		μV_{rms}
PSRR	Power-supply rejection ratio ⁽²⁾	vs V_{DD1} , at DC		-80		dB
		vs V_{DD2} , at DC		-85		
		vs V_{DD1} , 10 kHz / 100-mV ripple		-65		
		vs V_{DD2} , 10 kHz / 100-mV ripple		-70		
V_{CMout}	Output common-mode voltage		1.39	1.44	1.49	V
V_{CLIPout}	Clipping differential output voltage	$V_{\text{OUT}} = (V_{\text{OUTP}} - V_{\text{OUTN}})$; $V_{IN} > V_{\text{Clipping}}$		2.49		V
V_{FAILSAFE}	Failsafe differential output voltage	$\text{SHTDN} = \text{high}$, or V_{DD1} undervoltage, or V_{DD1} missing		-2.6	-2.5	V
BW	Output bandwidth		220	275		kHz
R_{OUT}	Output resistance	On OUTP or OUTN		<0.2		Ω
	Output short-circuit current	On OUTP or OUTN , sourcing or sinking, $\text{IN} = \text{GND1}$, outputs shorted to either GND or V_{DD2}		14		mA
CMTI	Common-mode transient immunity		100	150		kV/ μs
DIGITAL INPUT						
I_{IN}	Input current	SHTDN pin , $\text{GND1} \leq \text{SHTDN} \leq V_{DD1}$	-70		1	μA
C_{IN}	Input capacitance	SHTDN pin		5		pF
V_{IH}	High-level input voltage		$0.7 \times V_{DD1}$			V
V_{IL}	Low-level input voltage				$0.3 \times V_{DD1}$	V

6.9 Electrical Characteristics (continued)

minimum and maximum specifications apply from $T_A = -40^\circ\text{C}$ to $+125^\circ\text{C}$, $V_{DD1} = 3.0\text{ V}$ to 5.5 V , $V_{DD2} = 3.0\text{ V}$ to 5.5 V , $V_{IN} = -0.1\text{ V}$ to 2 V , and $\text{SHTDN} = \text{GND1} = 0\text{ V}$ (unless otherwise noted); typical specifications are at $T_A = 25^\circ\text{C}$, $V_{DD1} = 5\text{ V}$, and $V_{DD2} = 3.3\text{ V}$

PARAMETER		TEST CONDITIONS	MIN	TYP	MAX	UNIT
POWER SUPPLY						
VDD1 _{UV}	VDD1 undervoltage detection threshold	VDD1 rising	2.5	2.7	2.9	V
		VDD1 falling	2.4	2.6	2.8	
VDD2 _{UV}	VDD2 undervoltage detection threshold	VDD2 rising	2.2	2.45	2.65	V
		VDD2 falling	1.85	2.0	2.2	
I _{DD1}	High-side supply current	3.0 V < VDD1 < 3.6 V		6.0	8.4	mA
		4.5 V < VDD1 < 5.5 V, SHTDN = low		7.1	9.7	
		SHTDN = VDD1		1.3		μA
I _{DD2}	Low-side supply current	3.0 V < VDD2 < 3.6 V		5.3	7.2	mA
		4.5 V < VDD2 < 5.5 V		5.9	8.1	

- (1) The typical value includes one standard deviation (*sigma*) at nominal operating conditions.
- (2) This parameter is input referred.
- (3) THD is the ratio of the rms sum of the amplitudes of first five higher harmonics to the amplitude of the fundamental.
- (4) Offset error temperature drift is calculated using the box method, as described by the following equation:

$$TCV_{OS} = (Value_{MAX} - Value_{MIN}) / TempRange$$
- (5) Gain error temperature drift is calculated using the box method, as described by the following equation:

$$TCE_G (ppm) = (Value_{MAX} - Value_{MIN}) / (Value_{(T=25^\circ\text{C})} \times TempRange) \times 10^6$$

6.10 Switching Characteristics

over operating ambient temperature range (unless otherwise noted)

PARAMETER		TEST CONDITIONS	MIN	TYP	MAX	UNIT
t_r	Output signal rise time			1.3		μs
t_f	Output signal fall time			1.3		μs
	IN to OUTx signal delay (50% – 10%)	Unfiltered output		1	1.5	μs
	IN to OUTx signal delay (50% – 50%)	Unfiltered output		1.6	2.1	μs
	IN to OUTx signal delay (50% – 90%)	Unfiltered output		2.5	3	μs
t_{AS}	Analog settling time	VDD1 step to 3.0 V with VDD2 \geq 3.0 V, to V_{OUTP} , V_{OUTN} valid, 0.1% settling		50	100	μs
t_{EN}	Device enable time	SHTDN high to low		50	100	μs
t_{SHTDN}	Device shutdown time	SHTDN low to high		3	10	μs

6.11 Timing Diagram

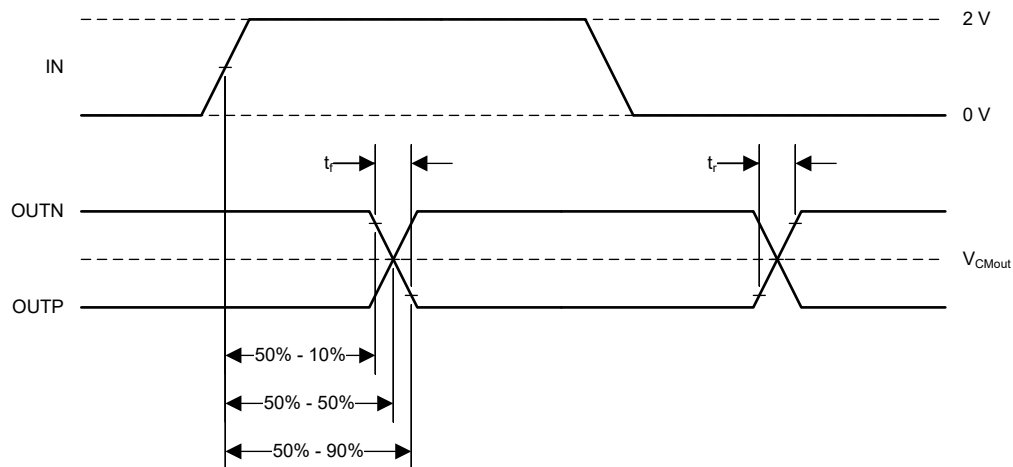

Figure 6-1. Rise, Fall, and Delay Time Definition

6.12 Insulation Characteristics Curves

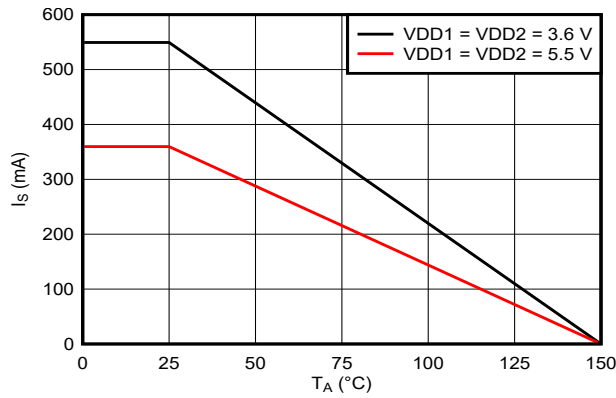

Figure 6-2. Thermal Derating Curve for Safety-Limiting Current per VDE

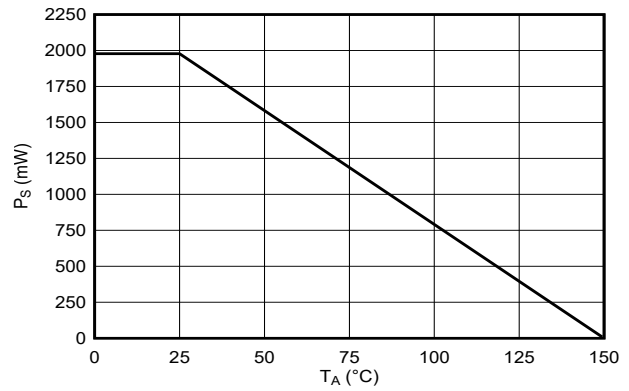
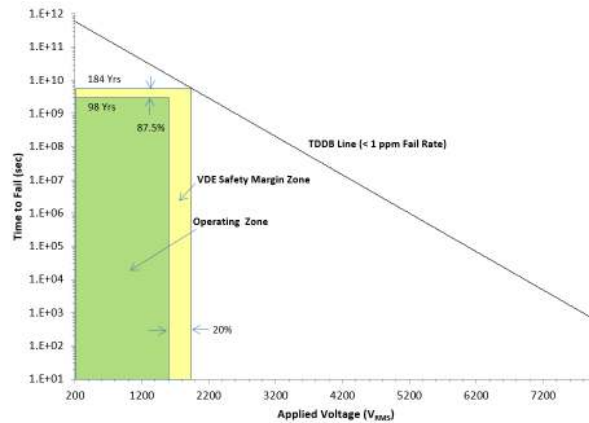

Figure 6-3. Thermal Derating Curve for Safety-Limiting Power per VDE



TA up to 150°C, stress-voltage frequency = 60 Hz, isolation working voltage = 1600 VRMS, projected insulation lifetime = 98 years

Figure 6-4. Reinforced Isolation Capacitor Lifetime Projection

6.13 Typical Characteristics

at VDD1 = 5 V, VDD2 = 3.3 V, SHTDN = 0 V, f_{IN} = 10 kHz, and BW = 100 kHz (unless otherwise noted)

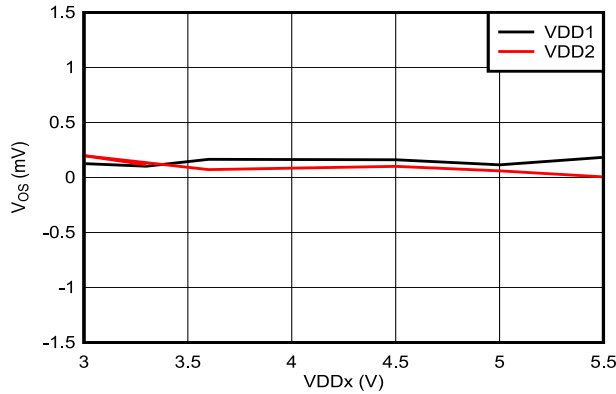

Figure 6-5. Input Offset Voltage vs Supply Voltage

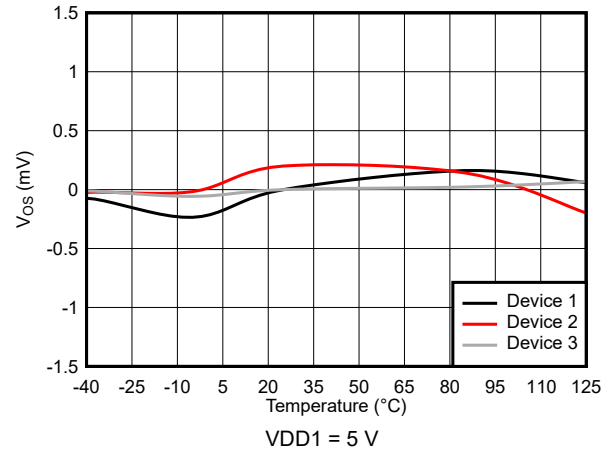

Figure 6-6. Input Offset Voltage vs Temperature

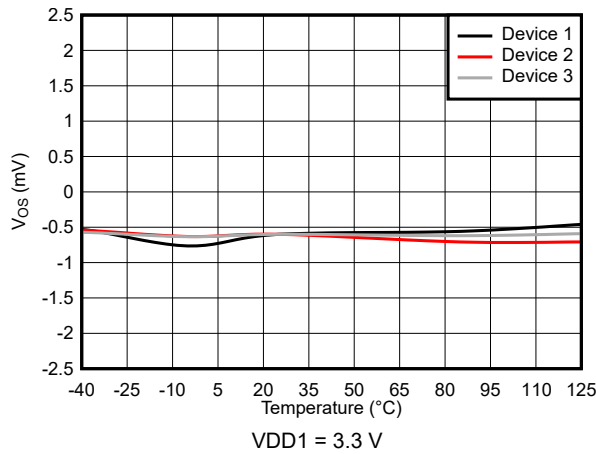

Figure 6-7. Input Offset Voltage vs Temperature

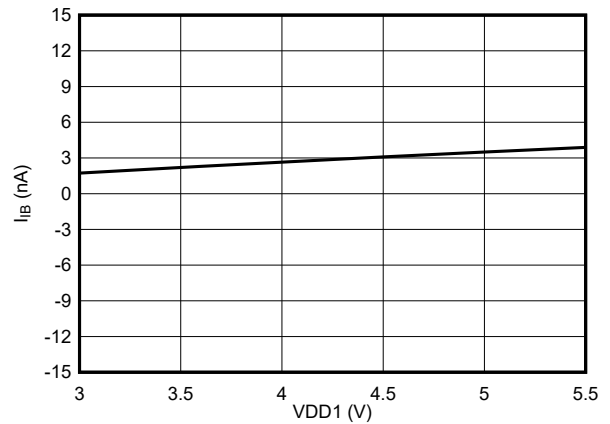

Figure 6-8. Input Bias Current vs High-Side Supply Voltage

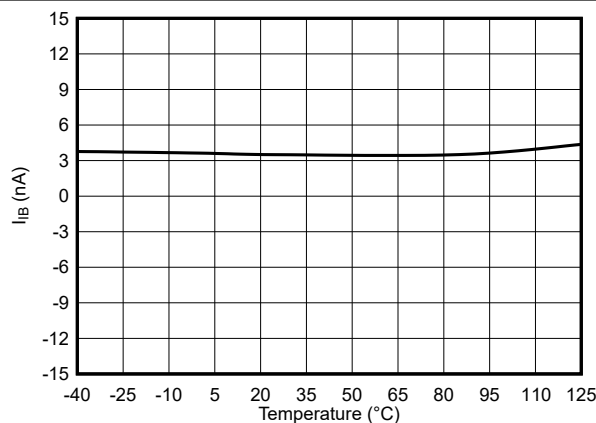

Figure 6-9. Input Bias Current vs Temperature

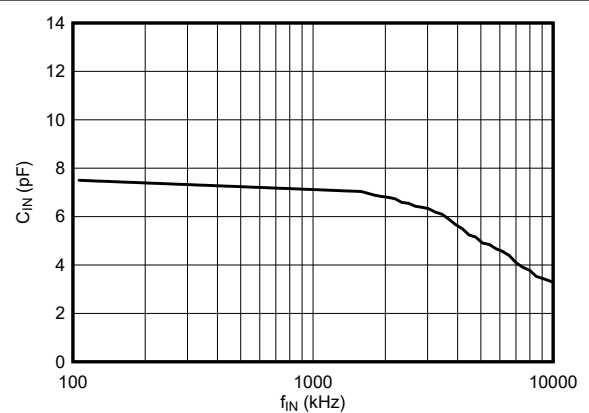

Figure 6-10. Input Capacitance vs Input Signal Frequency

6.13 Typical Characteristics (continued)

at VDD1 = 5 V, VDD2 = 3.3 V, SHTDN = 0 V, f_{IN} = 10 kHz, and BW = 100 kHz (unless otherwise noted)

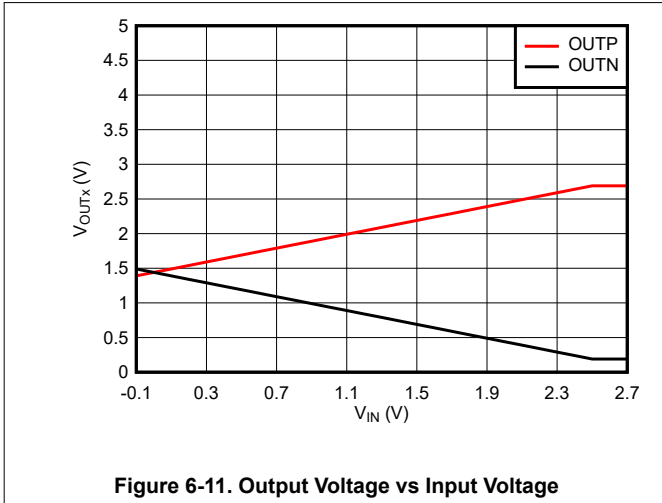

Figure 6-11. Output Voltage vs Input Voltage

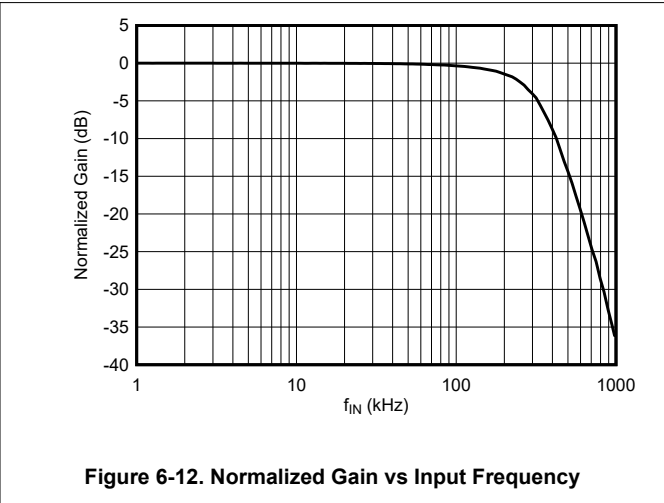

Figure 6-12. Normalized Gain vs Input Frequency

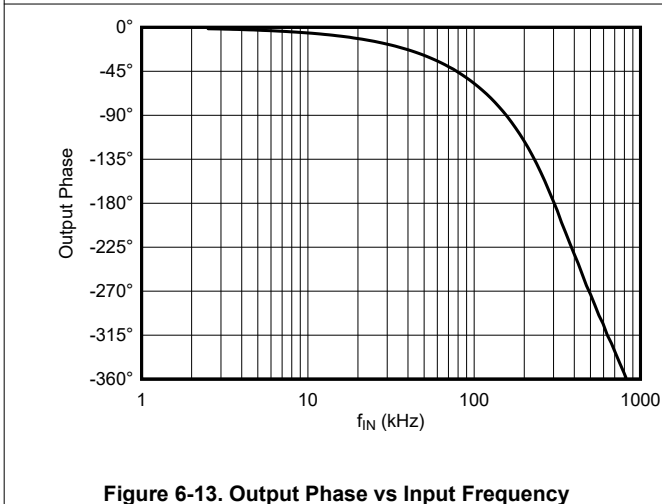

Figure 6-13. Output Phase vs Input Frequency

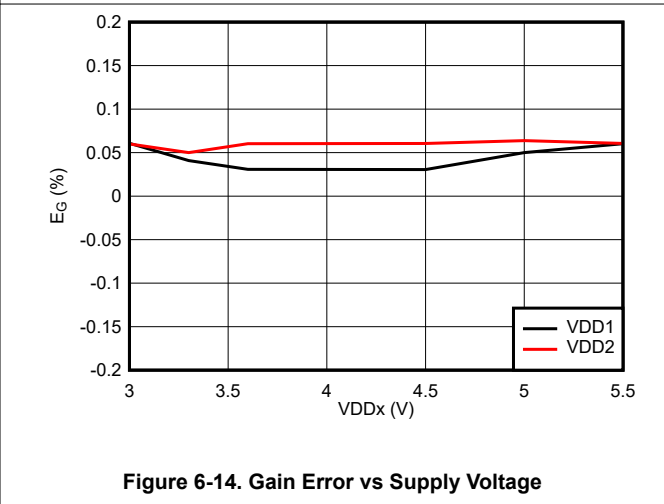

Figure 6-14. Gain Error vs Supply Voltage

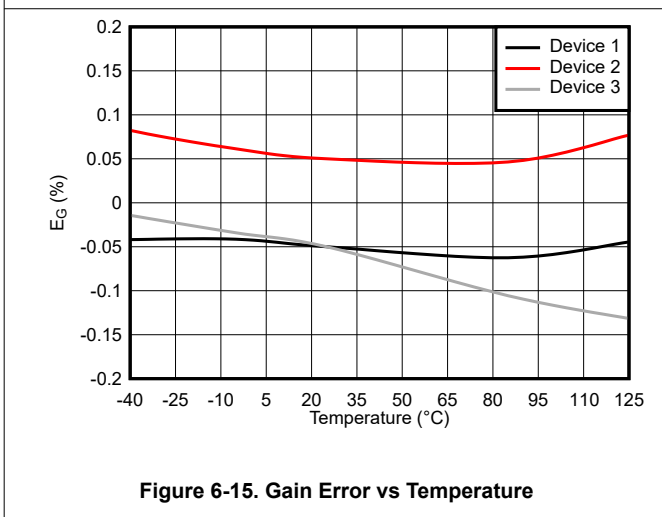

Figure 6-15. Gain Error vs Temperature

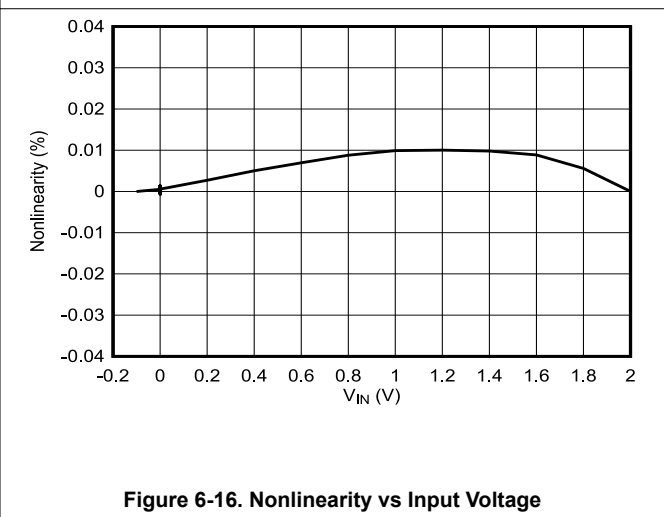

Figure 6-16. Nonlinearity vs Input Voltage

6.13 Typical Characteristics (continued)

at VDD1 = 5 V, VDD2 = 3.3 V, SHTDN = 0 V, f_{IN} = 10 kHz, and BW = 100 kHz (unless otherwise noted)

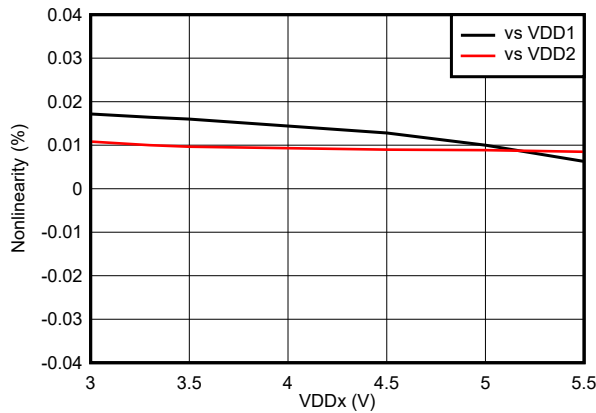

Figure 6-17. Nonlinearity vs Supply Voltage

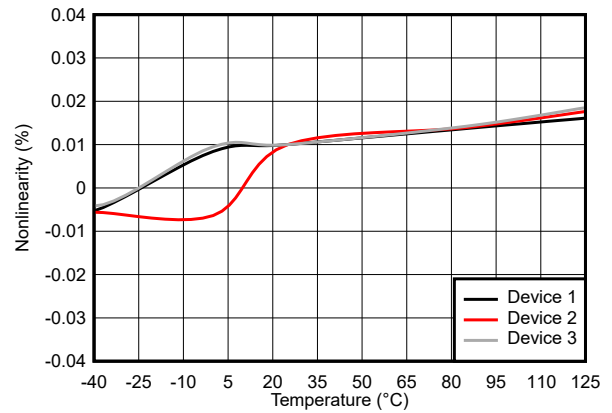

Figure 6-18. Nonlinearity vs Temperature

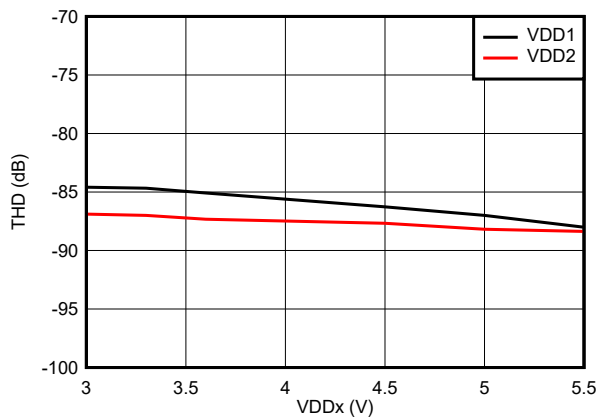

Figure 6-19. Total Harmonic Distortion vs Supply Voltage

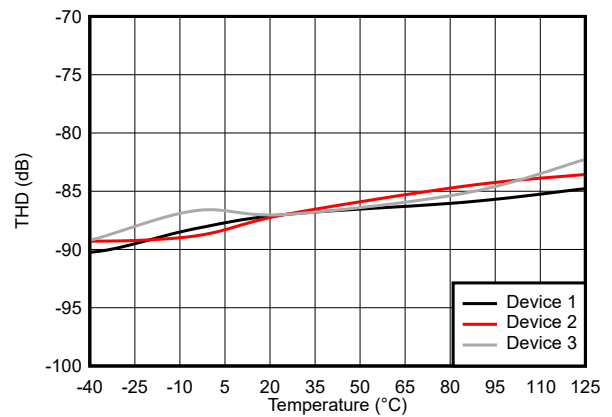

Figure 6-20. Total Harmonic Distortion vs Temperature

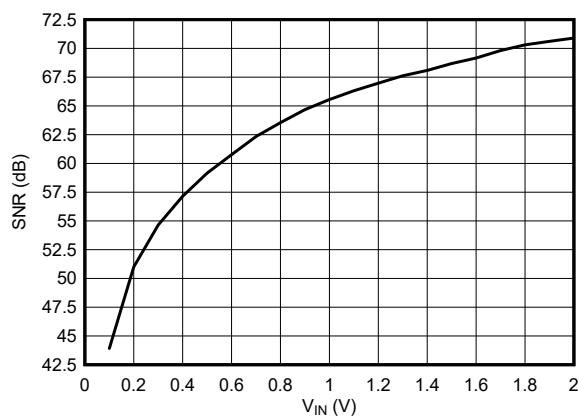

Figure 6-21. Signal-to-Noise Ratio vs Input Voltage

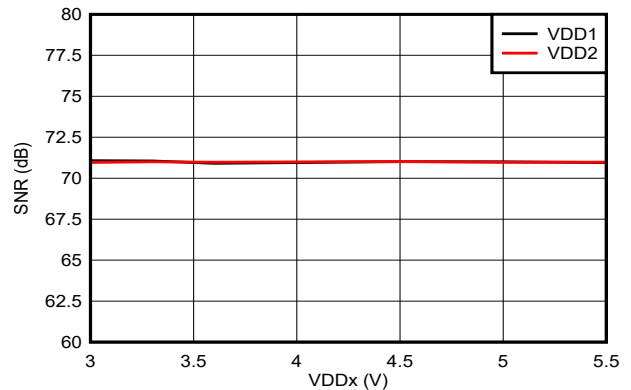

Figure 6-22. Signal-to-Noise Ratio vs Supply Voltage

6.13 Typical Characteristics (continued)

at VDD1 = 5 V, VDD2 = 3.3 V, SHTDN = 0 V, f_{IN} = 10 kHz, and BW = 100 kHz (unless otherwise noted)

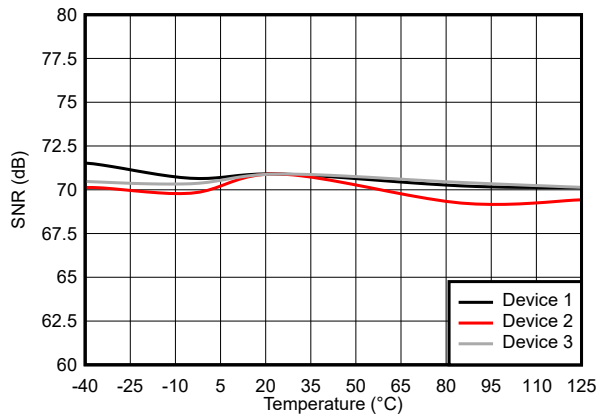

Figure 6-23. Signal-to-Noise Ratio vs Temperature

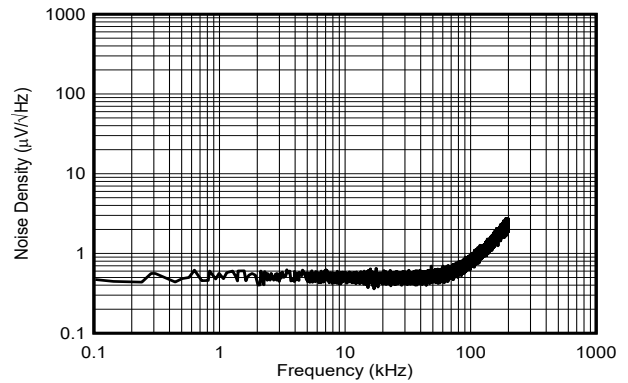

Figure 6-24. Input-Referred Noise Density vs Frequency

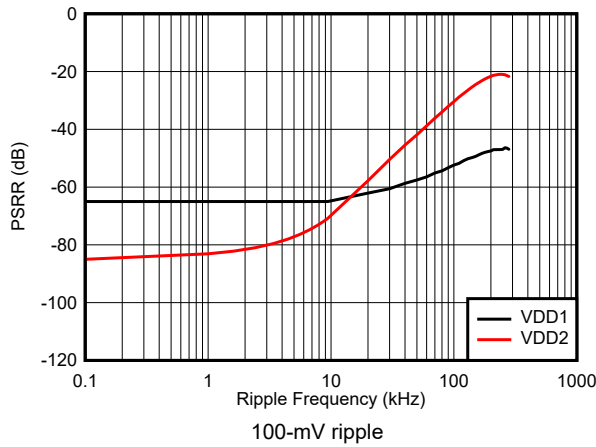

Figure 6-25. Power-Supply Rejection Ratio vs Ripple Frequency

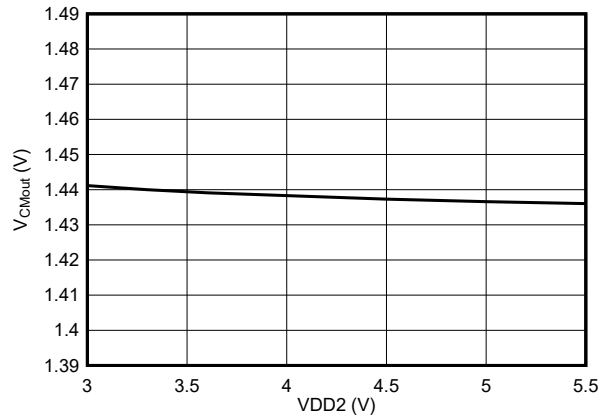

Figure 6-26. Output Common-Mode Voltage vs Low-Side Supply Voltage

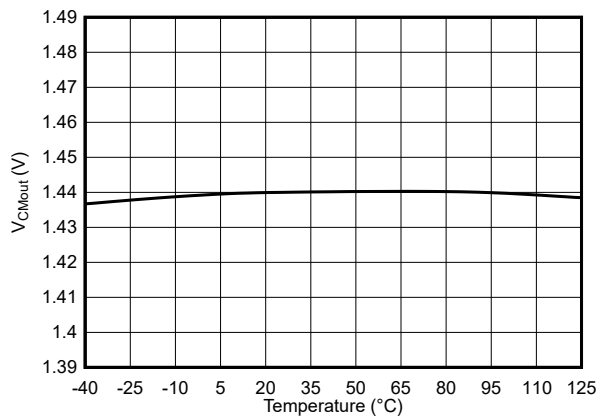

Figure 6-27. Output Common-Mode Voltage vs Temperature

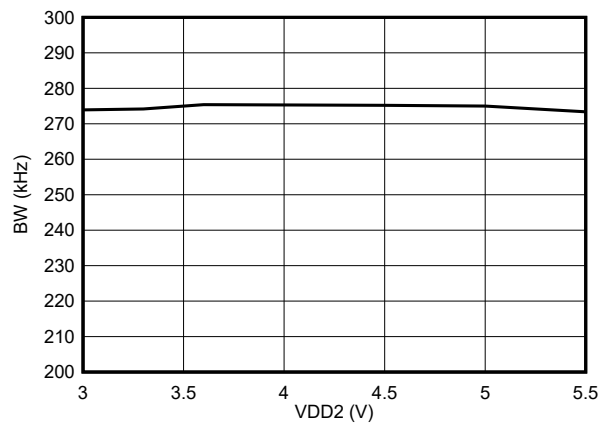

Figure 6-28. Output Bandwidth vs Low-Side Supply Voltage

6.13 Typical Characteristics (continued)

at VDD1 = 5 V, VDD2 = 3.3 V, SHTDN = 0 V, $f_{IN} = 10$ kHz, and BW = 100 kHz (unless otherwise noted)

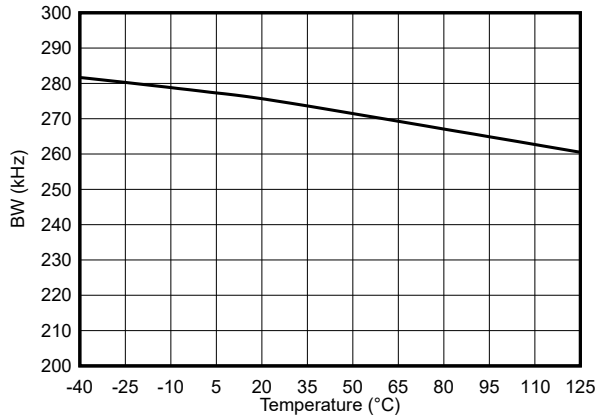

Figure 6-29. Output Bandwidth vs Temperature

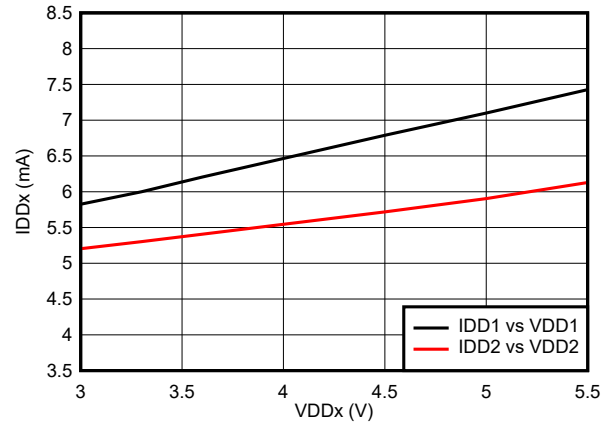

Figure 6-30. Supply Current vs Supply Voltage

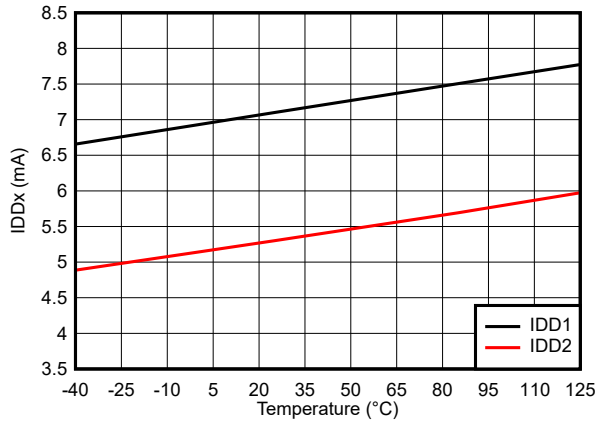

Figure 6-31. Supply Current vs Temperature

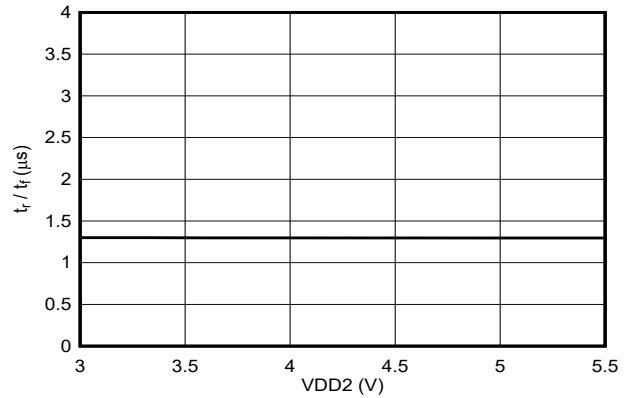

Figure 6-32. Output Rise and Fall Time vs Low-Side Supply Voltage

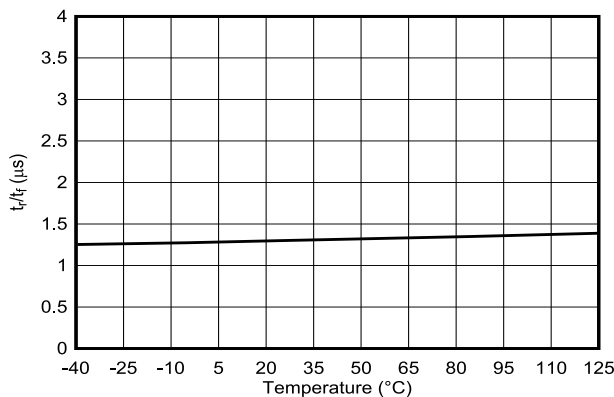

Figure 6-33. Output Rise and Fall Time vs Temperature

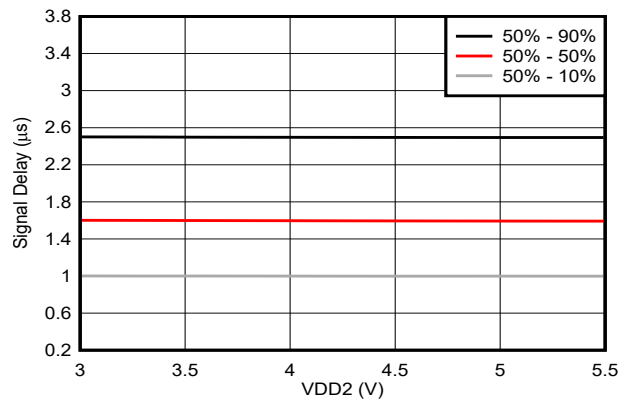

Figure 6-34. IN to OUTP, OUTN Signal Delay vs Low-Side Supply Voltage

6.13 Typical Characteristics (continued)

at VDD1 = 5 V, VDD2 = 3.3 V, SHTDN = 0 V, f_{IN} = 10 kHz, and BW = 100 kHz (unless otherwise noted)

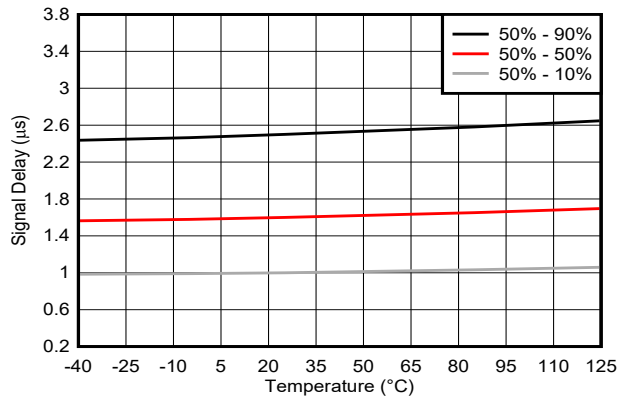

Figure 6-35. IN to OUTP, OUTN Signal Delay vs Temperature

7 Detailed Description

7.1 Overview

The AMC1411-Q1 is a precision, single-ended input, isolated amplifier with a high input-impedance and wide input voltage range. The input stage of the device drives a second-order, delta-sigma ($\Delta\Sigma$) modulator. The modulator converts the analog input signal into a digital bitstream that is transferred across the isolation barrier and separates the high-side from the low-side. On the low-side, the received bitstream is processed by a fourth-order analog filter that outputs a differential signal at the OUTP and OUTN pins proportional to the input signal.

The SiO₂-based, capacitive isolation barrier supports a high level of magnetic field immunity, as described in the [ISO72x Digital Isolator Magnetic-Field Immunity application report](#). The digital modulation used in the AMC1411-Q1 to transmit data across the isolation barrier, and the isolation barrier characteristics itself, result in high reliability and common-mode transient immunity.

7.2 Functional Block Diagram

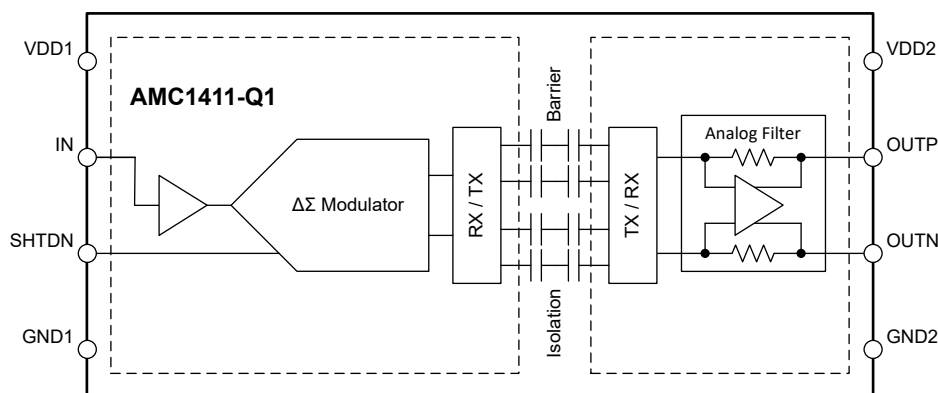

7.3 Feature Description

7.3.1 Analog Input

The single-ended, high-impedance input stage of the AMC1411-Q1 feeds a second-order, switched-capacitor, feed-forward $\Delta\Sigma$ modulator. The modulator converts the analog signal into a bitstream that is transferred across the isolation barrier, as described in the [Isolation Channel Signal Transmission](#) section.

There are two restrictions on the analog input signal IN. First, if the input voltage V_{IN} exceeds the range specified in the [Absolute Maximum Ratings](#) table, the input current must be limited to the absolute maximum value, because the electrostatic discharge (ESD) protection turns on. In addition, the linearity and parametric performance of the device is ensured only when the analog input voltage remains within the linear full-scale range (V_{FSR}) as specified in the [Recommended Operating Conditions](#) table.

7.3.2 Isolation Channel Signal Transmission

The AMC1411-Q1 uses an on-off keying (OOK) modulation scheme, as shown in Figure 7-1, to transmit the modulator output bitstream across the SiO₂-based isolation barrier. The transmit driver (TX) shown in the *Functional Block Diagram* transmits an internally-generated, high-frequency carrier across the isolation barrier to represent a digital *one* and does not send a signal to represent a digital *zero*. The nominal frequency of the carrier used inside the AMC1411-Q1 is 480 MHz.

The receiver (RX) on the other side of the isolation barrier recovers and demodulates the signal and provides the input to the fourth-order analog filter. The AMC1411-Q1 transmission channel is optimized to achieve the highest level of common-mode transient immunity (CMTI) and lowest level of radiated emissions caused by the high-frequency carrier and RX/TX buffer switching.

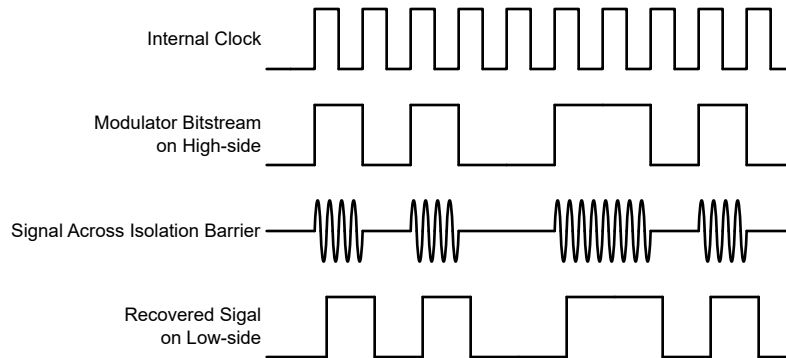

Figure 7-1. OOK-Based Modulation Scheme

7.3.3 Analog Output

The AMC1411-Q1 provides a differential analog output on the OUP_T and OUT_N pins. For input voltages V_{IN} in the range from -0.1 V to $+2$ V, the device provides a linear response with a nominal gain of 1. For example, for an input voltage of 2 V, the differential output voltage ($V_{OUTP} - V_{OUTN}$) is 2 V. At zero input (IN shorted to GND1), both pins output the same common-mode output voltage V_{CMout} , as specified in the [Electrical Characteristics](#) table. For input voltages greater than 2 V but less than approximately 2.5 V, the differential output voltage continues to increase but with reduced linearity performance. The outputs saturate at a differential output voltage of $V_{CLIPout}$, as shown in [Figure 7-2](#), if the input voltage exceeds the $V_{Clipping}$ value.

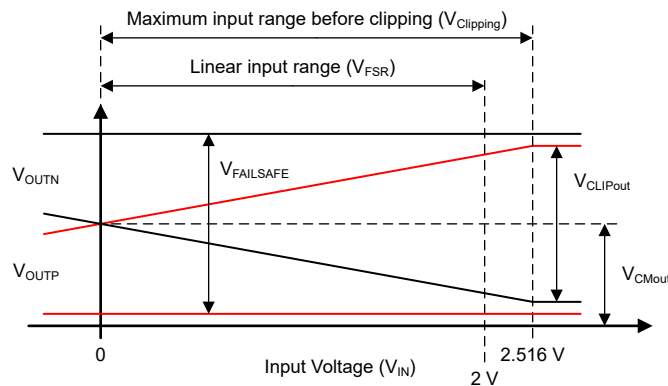

Figure 7-2. Output Behavior of the AMC1411-Q1

The AMC1411-Q1 output offers a fail-safe feature that simplifies diagnostics on system level. [Figure 7-2](#) shows the fail-safe mode, in which the AMC1411-Q1 outputs a negative differential output voltage that does not occur under normal operating conditions. The fail-safe output is active in three cases:

- When the high-side supply VDD1 of the AMC1411-Q1 device is missing
- When the high-side supply VDD1 falls below the undervoltage threshold $VDD1_{UV}$
- When the SHTDN pin is pulled high

Use the maximum $V_{FAILSAFE}$ voltage specified in the [Electrical Characteristics](#) table as a reference value for fail-safe detection on a system level.

7.4 Device Functional Modes

The AMC1411-Q1 is operational when the power supplies VDD1 and VDD2 are applied as specified in the [Recommended Operating Conditions](#) table.

8 Application and Implementation

Note

Information in the following applications sections is not part of the TI component specification, and TI does not warrant its accuracy or completeness. TI's customers are responsible for determining suitability of components for their purposes, as well as validating and testing their design implementation to confirm system functionality.

8.1 Application Information

The high input impedance, low input bias current, excellent accuracy, and low temperature drift make the AMC1411-Q1 a high-performance solution for automotive applications where voltage sensing in the presence of high common-mode voltage levels is required.

8.2 Typical Application

Reinforced isolated amplifiers are commonly offered in SOIC packages with less than 9 mm of clearance and creepage specification. Automotive systems supporting working voltages greater than 850 V, designed for altitudes greater than 2000 m or for environments with pollution degree 2 or higher, may require clearance and creepage distances greater than 9 mm. Examples are OBC, DC/DC converters, and traction inverters for 800-V automotive battery systems that support DC-bus voltages up to 1000 V.

The AMC1411-Q1 comes in a SOIC package with greater than 15.7 mm of creepage distance and is specifically designed for use in high-voltage systems that require accurate voltage monitoring and reinforced isolation between high-voltage and low-voltage parts of the system.

Figure 8-1 shows an OBC that uses the AMC1411-Q1 to monitor the DC-bus voltage that can be as high as 1000 V. The DC-bus voltage is divided down to an approximate 2-V level across the bottom resistor (RSNS) of a high-impedance resistive divider that is sensed by the AMC1411-Q1. The output of the AMC1411-Q1 is a differential analog output voltage of the same value as the input voltage but is galvanically isolated from the high-side by a reinforced isolation barrier.

The wide creepage and clearance, high isolation voltage rating, and high common-mode transient immunity (CMTI) of the AMC1411-Q1 ensure reliable and accurate operation in harsh and high-noise environments.

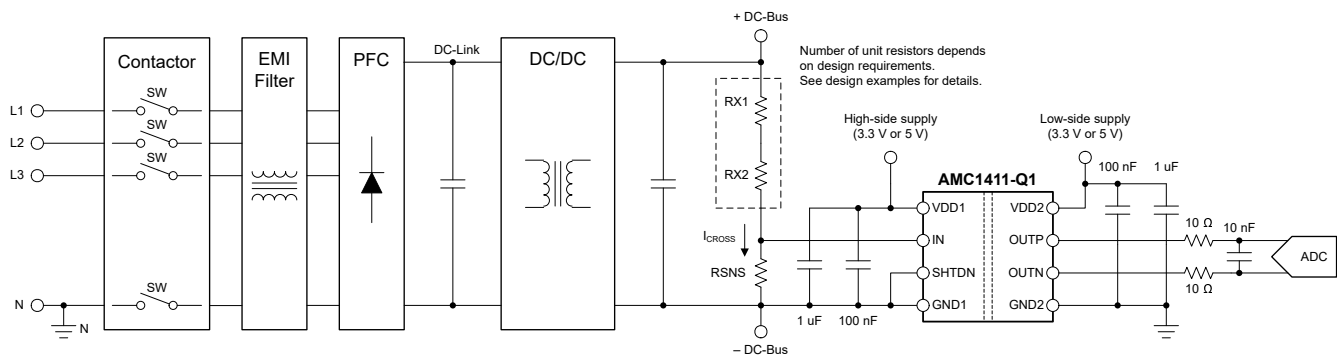

Figure 8-1. Using the AMC1411-Q1 for DC Bus Voltage Sensing in an OBC

8.2.1 Design Requirements

Table 8-1 lists the parameters for this typical application.

Table 8-1. Design Requirements

PARAMETER	VALUE
DC-bus voltage	1000 V (maximum)
Overtoltage category	II
Altitude	≤4000 m
High-side supply voltage	3.3 V or 5 V
Low-side supply voltage	3.3 V or 5 V
Maximum resistor operating voltage	100 V
Voltage drop across the sense resistor (RSNS) for a linear response	2 V (maximum)
Current through the resistive divider, I _{CROSS}	100 μA

8.2.2 Detailed Design Procedure

The 100-μA cross-current requirement at the maximum DC-bus voltage (1000 V) determines that the total impedance of the resistive divider is 10 MΩ. The impedance of the resistive divider is dominated by the top portion (shown exemplary as RX1 and RX2 in Figure 8-1) and the voltage drop across RSNS can be neglected for a moment. The maximum allowed voltage drop per unit resistor is specified as 100 V; therefore, the minimum number of unit resistors in the top portion of the resistive divider is 1000 V / 100 V = 10. The calculated unit value is 10 MΩ / 10 = 1 MΩ and matches a value from the E96 series.

RSNS is sized such that the voltage drop across the resistor at the maximum DC-bus voltage (1000 V) equals the linear full-scale range input voltage (V_{FSR}) of the AMC1411-Q1, which is 2 V. This voltage is calculated as $RSNS = V_{FSR} / (V_{DC-Bus, max} - V_{FSR}) \times R_{TOP}$, where R_{TOP} is the total value of the top resistor string (10 × 1 MΩ = 10 MΩ). RSNS is calculated as 20.04 kΩ. The next closest, lower value from the E96 series is 20 kΩ.

Table 8-2 summarizes the design of the resistive divider.

Table 8-2. Resistor Value Example

PARAMETER	VALUE
Unit resistor value, RX	1 MΩ
Number of unit resistors	10
Sense resistor value, RSNS	20 kΩ
Total resistance value	10.02 MΩ
Resulting current through resistive divider, I _{CROSS}	99.8 μA
Resulting full-scale voltage drop across sense resistor RSNS	1.996 V
Power dissipated in unit resistor RX	10 mW
Total power dissipated in resistive divider	99.8 mW

8.2.2.1 Insulation Coordination

In this example of an OBC, isolation between the high-voltage and low-voltage parts of the system is checked against the requirements of the IEC60664-1 *Insulation coordination for equipment within low-voltage systems* standard. Isolation must be designed to withstand the rated impulse voltage, temporary overvoltage, and the working voltage. In addition, the physical distance between exposed metal parts on the high- and low-voltage side must meet the minimum creepage and clearance requirements.

Table B.1 of the IEC60664-1 standard defines the impulse voltage for a 1000-V, unearthed system with OVC II as 6000 V. This value is lower than the maximum V_{IOSM} (8000 V_{PK}) rating of the AMC1411-Q1.

Table B.1 of the IEC60664-1 standard also defines the system voltage of a 1000-V, unearthed system as 1000 V. The temporary overvoltage for a system voltage of 1000 V is 2200 V and is derived using the formula (1200 V + system voltage) from IEC60664-1. The value must be doubled for reinforced isolation, resulting in 4400 V_{RMS} or 6250 V_{PK} . This value is lower than the maximum V_{IOTM} (10500 V_{PK}) rating of the AMC1411-Q1.

The working voltage in this example is 1000 V_{DC} and is also lower than V_{IOWM} (2260 V_{DC}) of the AMC1411-Q1.

The minimum clearance for a 6000-V impulse voltage according the IEC60664-1, table F.2, is 8.0 mm for reinforced isolation. For reinforced insulation, the minimum clearance value is taken from the line corresponding to the next higher impulse voltage rating (8000 V), following the guidelines for reinforced isolation. The equipment is designed to operate at altitudes up to 4000 m above sea level and the minimum clearance must be increased to $1.29 \times 8 \text{ mm} = 10.4 \text{ mm}$ (rounded up). The factor of 1.29 is taken from table A.2 of the IEC60664-1 standard. The AMC1411-Q1 provides a minimum clearance of 14.7 mm and meets the requirement.

Finally, the minimum creepage distance for a working voltage of 1000 V_{DC} , insulating material group I, pollution degree 2, reinforced isolation is $2 \times 5 \text{ mm} = 10 \text{ mm}$ according to IEC60664-1 table F.4. 5 mm is the value for 1000-V basic insulation and is doubled for reinforced isolation. The AMC1411-Q1 provides a minimum creepage of 15.7 mm and provides significant margin against the minimum requirement.

8.2.2.2 Input Filter Design

Placing an RC filter in front of the isolated amplifier improves signal-to-noise performance of the signal path. In practice, however, the impedance of the resistor divider is so high that adding a filter capacitor on the IN pin limits the signal bandwidth to an unacceptable low limit, such that the filter capacitor is omitted. When used, design the input filter such that:

- The cutoff frequency of the filter is at least one order of magnitude lower than the sampling frequency (20 MHz) of the internal $\Delta\Sigma$ modulator
- The input bias current does not generate significant voltage drop across the DC impedance of the input filter

Most voltage-sensing applications use high-impedance resistor dividers in front of the isolated amplifier to scale down the input voltage. In this case, a single capacitor (as shown in [Figure 8-2](#)) is sufficient to filter the input signal.

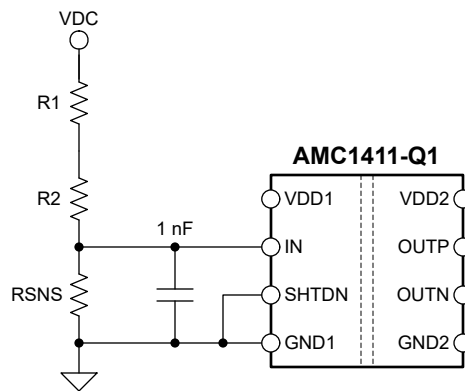

Figure 8-2. Input Filter

8.2.2.3 Differential-to-Single-Ended Output Conversion

Figure 8-3 shows an example of a TLV313-Q1-based signal conversion and filter circuit for systems using single-ended input ADCs to convert the analog output voltage into digital. With $R1 = R2 = R3 = R4$, the output voltage equals $(V_{OUTP} - V_{OUTN}) + V_{REF}$. Tailor the bandwidth of this filter stage to the bandwidth requirement of the system and use NP0-type capacitors for best performance. For most applications, $R1 = R2 = R3 = R4 = 3.3\text{ k}\Omega$ and $C1 = C2 = 330\text{ pF}$ yields good performance.

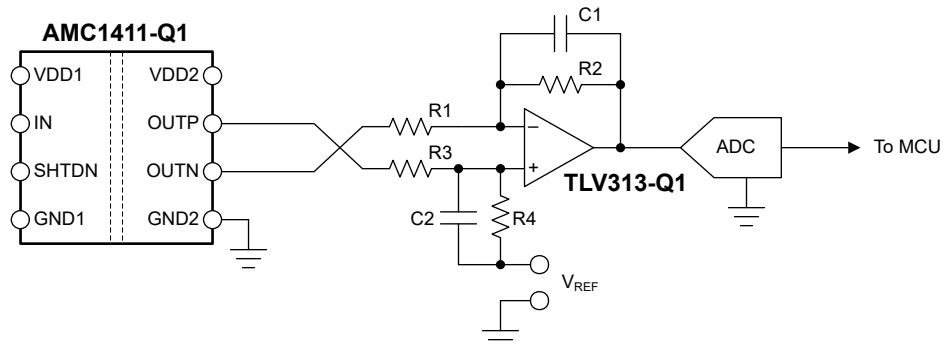

Figure 8-3. Connecting the AMC1411-Q1 Output to a Single-Ended Input ADC

For more information on the general procedure to design the filtering and driving stages of SAR ADCs, see the [18-Bit, 1MSPS Data Acquisition Block \(DAQ\) Optimized for Lowest Distortion and Noise](#) and [18-Bit Data Acquisition Block \(DAQ\) Optimized for Lowest Power](#) reference guides, available for download at www.ti.com.

8.2.3 Application Curve

One important aspect of system design is the effective detection of an overvoltage condition to protect switching devices and passive components from damage. To power off the system quickly in the event of an overvoltage condition, a low delay caused by the isolated amplifier is required. Figure 8-4 shows the typical full-scale step response of the AMC1411-Q1.

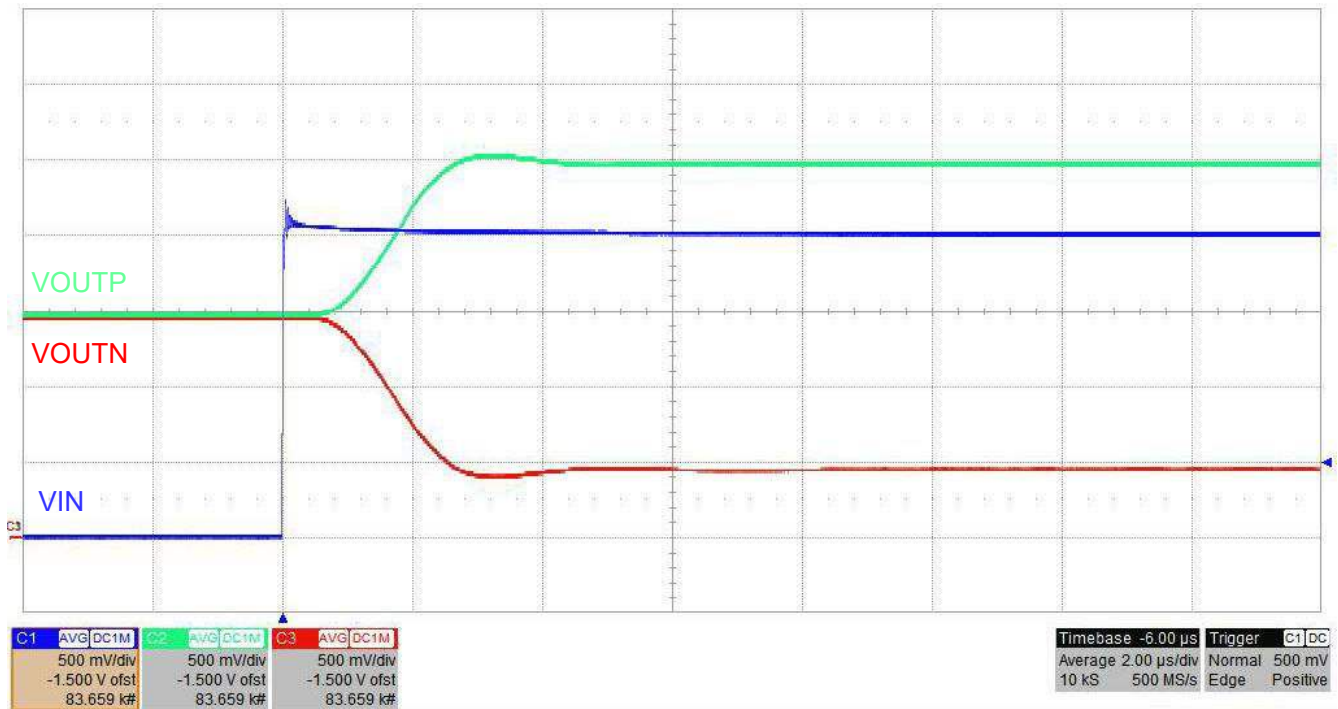

Figure 8-4. Step Response of the AMC1411-Q1

8.3 What To Do and What Not To Do

Do not leave the analog input (IN) of the AMC1411-Q1 unconnected (floating) when the device is powered up on the high-side. If the device input is left floating, the bias current may generate a negative input voltage that exceeds the specified input voltage range and the output of the device is invalid.

Do not connect protection diodes to the input (IN) of the AMC1411-Q1. Diode leakage current can introduce significant measurement error especially at high temperatures. The input pin is protected against high voltages by its ESD protection circuit and the high impedance of the external resistive divider.

9 Power Supply Recommendations

In a typical application, the high-side (VDD1) of the AMC1411-Q1 is powered from an already existing, high-side-ground referenced 3.3-V or 5-V power supply in the system. Alternatively, the high-side supply can be generated from the low-side supply (VDD2) by an isolated DC/DC converter. A low-cost solution is based on the push-pull driver [SN6501](#) and a transformer that supports the desired isolation voltage ratings.

The AMC1411-Q1 does not require any specific power-up sequencing. The high-side power supply (VDD1) is decoupled with a low-ESR, 100-nF capacitor (C1) parallel to a low-ESR, 1- μ F capacitor (C2). The low-side power supply (VDD2) is equally decoupled with a low-ESR, 100-nF capacitor (C3) parallel to a low-ESR, 1- μ F capacitor (C4). Place all four capacitors (C1, C2, C3, and C4) as close to the device as possible. [Figure 9-1](#) shows the proper decoupling layout for the AMC1411-Q1.

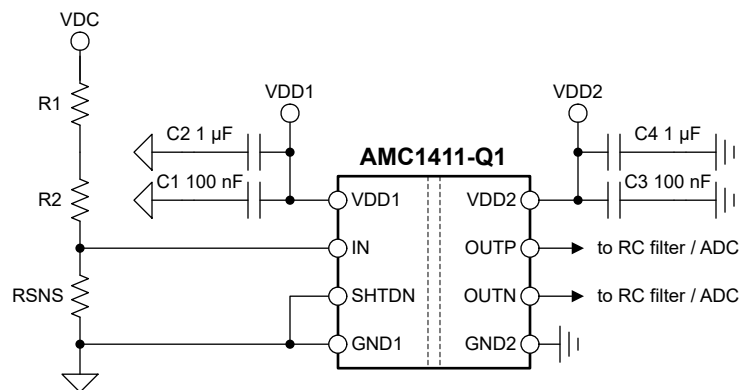

Figure 9-1. Decoupling of the AMC1411-Q1

Capacitors must provide adequate effective capacitance under the applicable DC bias conditions they experience in the application. Multilayer ceramic capacitors (MLCC) typically exhibit only a fraction of their nominal capacitance under real-world conditions and this factor must be taken into consideration when selecting these capacitors. This problem is especially acute in low-profile capacitors, in which the dielectric field strength is higher than in taller components. Reputable capacitor manufacturers provide capacitance versus DC bias curves that greatly simplify component selection.

10 Layout

10.1 Layout Guidelines

Figure 10-1 shows a layout recommendation with the critical placement of the decoupling capacitors (as close as possible to the AMC1411-Q1 supply pins) and placement of the other components required by the device. For best performance, place the sense resistor close to the device input pin (IN).

10.2 Layout Example

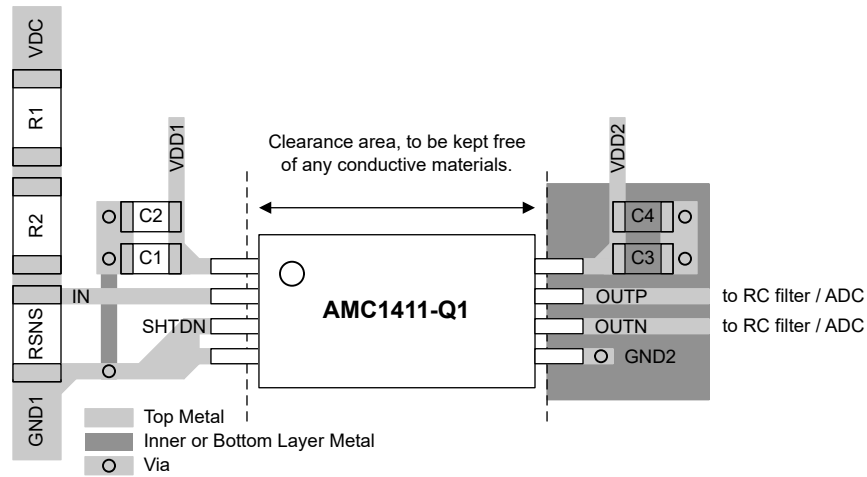

Figure 10-1. Recommended Layout of the AMC1411-Q1

11 Device and Documentation Support

11.1 Documentation Support

11.1.1 Related Documentation

For related documentation, see the following:

- Texas Instruments, [Isolation Glossary application report](#)
- Texas Instruments, [Semiconductor and IC Package Thermal Metrics application report](#)
- Texas Instruments, [ISO72x Digital Isolator Magnetic-Field Immunity application report](#)
- Texas Instruments, [TLVx313-Q1 Low-Power, Rail-to-Rail In/Out, 750- \$\mu\$ V Typical Offset, 1-MHz Operational Amplifier for Cost-Sensitive Systems data sheet](#)
- Texas Instrument, [SN6501-Q1 Transformer Driver for Isolated Power Supplies data sheet](#)
- Texas Instruments, [18-Bit, 1-MSPS Data Acquisition Block \(DAQ\) Optimized for Lowest Distortion and Noise design guide](#)
- Texas Instruments, [18-Bit, 1-MSPS Data Acquisition Block \(DAQ\) Optimized for Lowest Power reference guide](#)
- Texas Instruments, [Isolated Amplifier Voltage Sensing Excel Calculator design tool](#)
- Texas Instruments, [Best in Class Radiated Emissions EMI Performance with the AMC1300B-Q1 Isolated Amplifier application note](#)

11.2 Receiving Notification of Documentation Updates

To receive notification of documentation updates, navigate to the device product folder on ti.com. Click on [Subscribe to updates](#) to register and receive a weekly digest of any product information that has changed. For change details, review the revision history included in any revised document.

11.3 Support Resources

[TI E2E™ support forums](#) are an engineer's go-to source for fast, verified answers and design help — straight from the experts. Search existing answers or ask your own question to get the quick design help you need.

Linked content is provided "AS IS" by the respective contributors. They do not constitute TI specifications and do not necessarily reflect TI's views; see TI's [Terms of Use](#).

11.4 Trademarks

TI E2E™ is a trademark of Texas Instruments.

All trademarks are the property of their respective owners.

11.5 Electrostatic Discharge Caution



This integrated circuit can be damaged by ESD. Texas Instruments recommends that all integrated circuits be handled with appropriate precautions. Failure to observe proper handling and installation procedures can cause damage.

ESD damage can range from subtle performance degradation to complete device failure. Precision integrated circuits may be more susceptible to damage because very small parametric changes could cause the device not to meet its published specifications.

11.6 Glossary

[TI Glossary](#) This glossary lists and explains terms, acronyms, and definitions.

12 Mechanical, Packaging, and Orderable Information

The following pages include mechanical, packaging, and orderable information. This information is the most current data available for the designated devices. This data is subject to change without notice and revision of this document. For browser-based versions of this data sheet, refer to the left-hand navigation.

PACKAGING INFORMATION

Orderable Device	Status (1)	Package Type	Package Drawing	Pins	Package Qty	Eco Plan (2)	Lead finish/ Ball material (6)	MSL Peak Temp (3)	Op Temp (°C)	Device Marking (4/5)	Samples
AMC1411QDWLRQ1	ACTIVE	SOIC	DWL	8	500	RoHS & Green	NIPDAU	Level-3-260C-168 HR	-40 to 125	1411Q	Samples

(1) The marketing status values are defined as follows:

ACTIVE: Product device recommended for new designs.

LIFEBUY: TI has announced that the device will be discontinued, and a lifetime-buy period is in effect.

NRND: Not recommended for new designs. Device is in production to support existing customers, but TI does not recommend using this part in a new design.

PREVIEW: Device has been announced but is not in production. Samples may or may not be available.

OBSOLETE: TI has discontinued the production of the device.

(2) **RoHS:** TI defines "RoHS" to mean semiconductor products that are compliant with the current EU RoHS requirements for all 10 RoHS substances, including the requirement that RoHS substance do not exceed 0.1% by weight in homogeneous materials. Where designed to be soldered at high temperatures, "RoHS" products are suitable for use in specified lead-free processes. TI may reference these types of products as "Pb-Free".

RoHS Exempt: TI defines "RoHS Exempt" to mean products that contain lead but are compliant with EU RoHS pursuant to a specific EU RoHS exemption.

Green: TI defines "Green" to mean the content of Chlorine (Cl) and Bromine (Br) based flame retardants meet JS709B low halogen requirements of <=1000ppm threshold. Antimony trioxide based flame retardants must also meet the <=1000ppm threshold requirement.

(3) MSL, Peak Temp. - The Moisture Sensitivity Level rating according to the JEDEC industry standard classifications, and peak solder temperature.

(4) There may be additional marking, which relates to the logo, the lot trace code information, or the environmental category on the device.

(5) Multiple Device Markings will be inside parentheses. Only one Device Marking contained in parentheses and separated by a "-" will appear on a device. If a line is indented then it is a continuation of the previous line and the two combined represent the entire Device Marking for that device.

(6) Lead finish/Ball material - Orderable Devices may have multiple material finish options. Finish options are separated by a vertical ruled line. Lead finish/Ball material values may wrap to two lines if the finish value exceeds the maximum column width.

Important Information and Disclaimer:The information provided on this page represents TI's knowledge and belief as of the date that it is provided. TI bases its knowledge and belief on information provided by third parties, and makes no representation or warranty as to the accuracy of such information. Efforts are underway to better integrate information from third parties. TI has taken and continues to take reasonable steps to provide representative and accurate information but may not have conducted destructive testing or chemical analysis on incoming materials and chemicals. TI and TI suppliers consider certain information to be proprietary, and thus CAS numbers and other limited information may not be available for release.

In no event shall TI's liability arising out of such information exceed the total purchase price of the TI part(s) at issue in this document sold by TI to Customer on an annual basis.

OTHER QUALIFIED VERSIONS OF AMC1411-Q1 :

- Catalog : [AMC1411](#)

NOTE: Qualified Version Definitions:

- Catalog - TI's standard catalog product

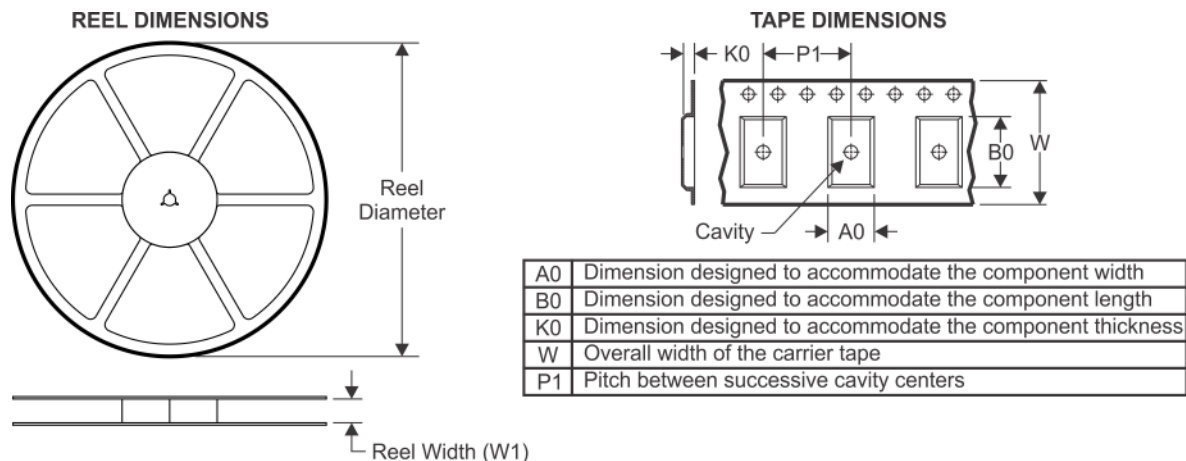
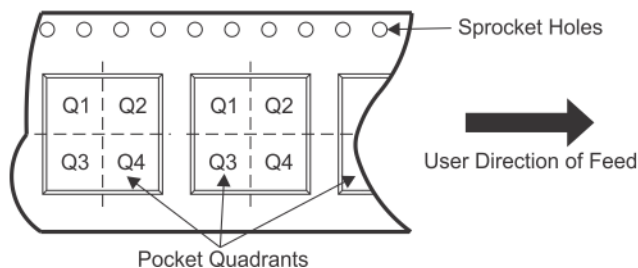
TAPE AND REEL INFORMATION

QUADRANT ASSIGNMENTS FOR PIN 1 ORIENTATION IN TAPE

*All dimensions are nominal

Device	Package Type	Package Drawing	Pins	SPQ	Reel Diameter (mm)	Reel Width W1 (mm)	A0 (mm)	B0 (mm)	K0 (mm)	P1 (mm)	W (mm)	Pin1 Quadrant
AMC1411QDWLRQ1	SOIC	DWL	8	500	330.0	24.4	18.55	7.2	4.5	24.0	24.0	Q1

TAPE AND REEL BOX DIMENSIONS

*All dimensions are nominal

Device	Package Type	Package Drawing	Pins	SPQ	Length (mm)	Width (mm)	Height (mm)
AMC1411QDWLRQ1	SOIC	DWL	8	500	367.0	367.0	45.0

DWL0008A

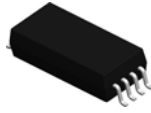

PACKAGE OUTLINE

SOIC - 4.034 mm max height

PLASTIC SMALL OUTLINE

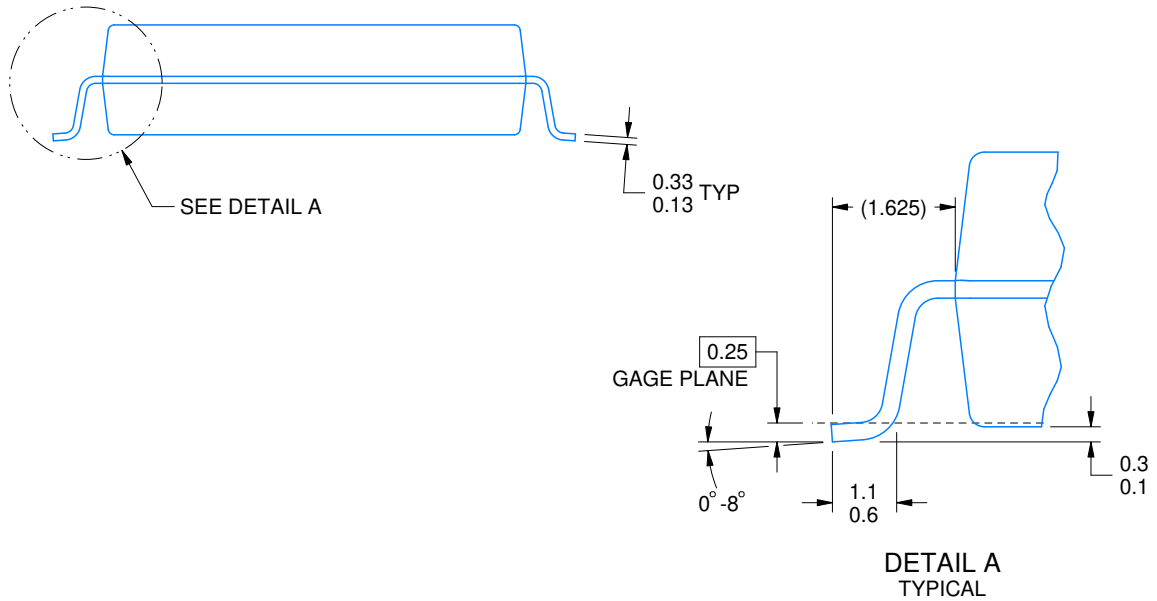
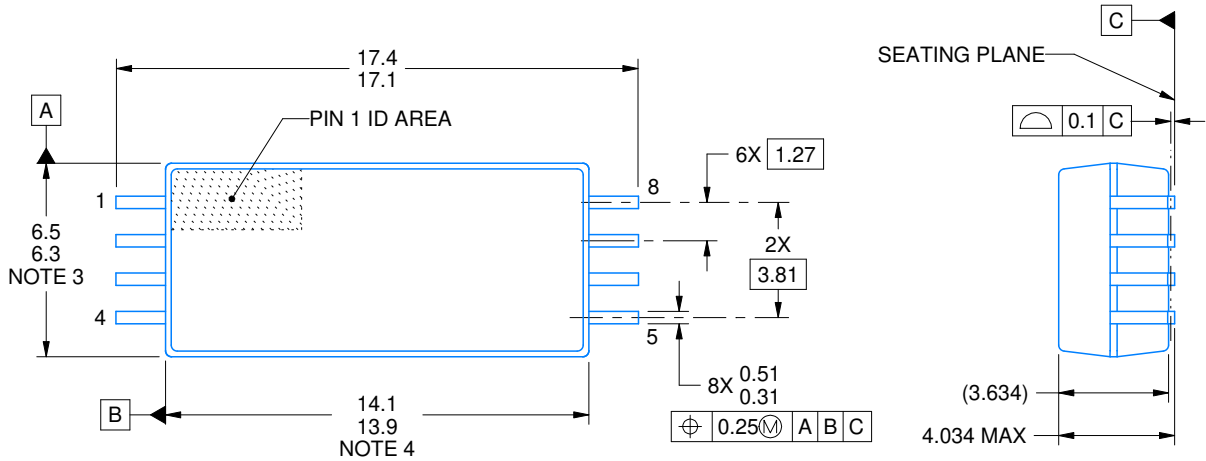

4224743/A 01/2019

NOTES:

1. All linear dimensions are in millimeters. Any dimensions in parenthesis are for reference only. Dimensioning and tolerancing per ASME Y14.5M.
2. This drawing is subject to change without notice.
3. This dimension does not include mold flash, protrusions, or gate burrs. Mold flash, protrusions, or gate burrs shall not exceed 0,15 mm per side.
4. This dimension does not include interlead flash.

EXAMPLE BOARD LAYOUT

DWL0008A

SOIC - 4.034 mm max height

PLASTIC SMALL OUTLINE

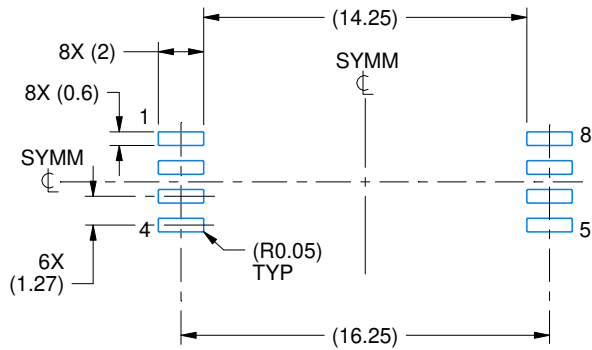

LAND PATTERN EXAMPLE
STANDARD
EXPOSED METAL SHOWN
SCALE:3X

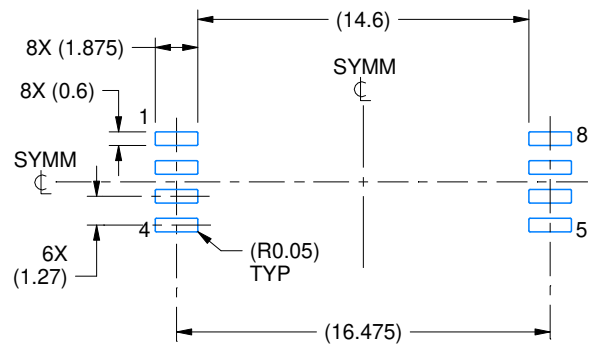

LAND PATTERN EXAMPLE
PCB CLEARANCE & CREEPAGE OPTIMIZED
EXPOSED METAL SHOWN
SCALE:3X

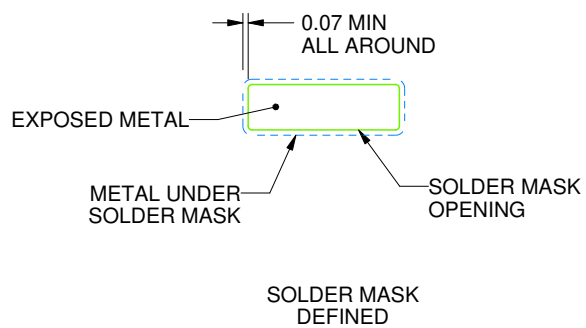
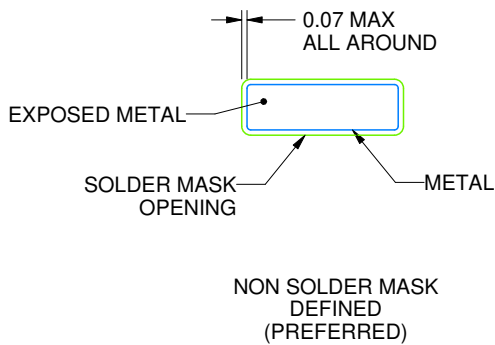

SOLDER MASK DETAILS

4224743/A 01/2019

NOTES: (continued)

5. Publication IPC-7351 may have alternate designs.
6. Solder mask tolerances between and around signal pads can vary based on board fabrication site.

EXAMPLE STENCIL DESIGN

DWL0008A

SOIC - 4.034 mm max height

PLASTIC SMALL OUTLINE

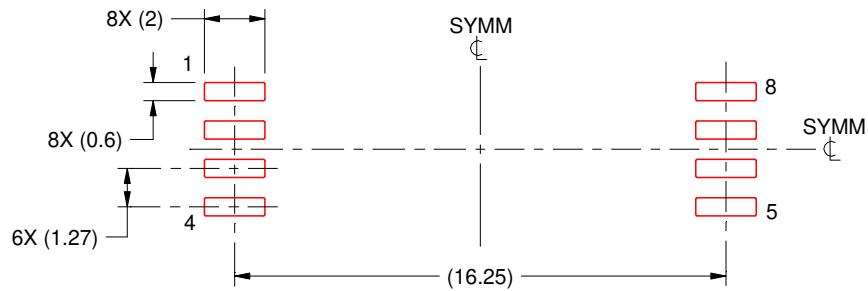

SOLDER PASTE EXAMPLE
STANDARD
BASED ON 0.125 mm THICK STENCIL
SCALE:4X

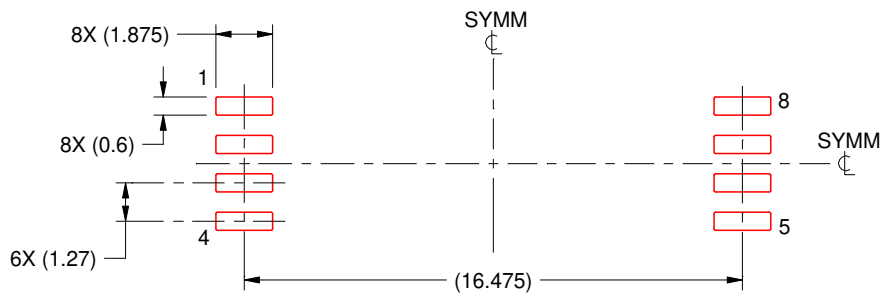

SOLDER PASTE EXAMPLE
PCB CLEARANCE & CREEPAGE OPTIMIZED
BASED ON 0.125 mm THICK STENCIL
SCALE:4X

4224743/A 01/2019

NOTES: (continued)

7. Laser cutting apertures with trapezoidal walls and rounded corners may offer better paste release. IPC-7525 may have alternate design recommendations.
8. Board assembly site may have different recommendations for stencil design.

IMPORTANT NOTICE AND DISCLAIMER

TI PROVIDES TECHNICAL AND RELIABILITY DATA (INCLUDING DATA SHEETS), DESIGN RESOURCES (INCLUDING REFERENCE DESIGNS), APPLICATION OR OTHER DESIGN ADVICE, WEB TOOLS, SAFETY INFORMATION, AND OTHER RESOURCES "AS IS" AND WITH ALL FAULTS, AND DISCLAIMS ALL WARRANTIES, EXPRESS AND IMPLIED, INCLUDING WITHOUT LIMITATION ANY IMPLIED WARRANTIES OF MERCHANTABILITY, FITNESS FOR A PARTICULAR PURPOSE OR NON-INFRINGEMENT OF THIRD PARTY INTELLECTUAL PROPERTY RIGHTS.

These resources are intended for skilled developers designing with TI products. You are solely responsible for (1) selecting the appropriate TI products for your application, (2) designing, validating and testing your application, and (3) ensuring your application meets applicable standards, and any other safety, security, regulatory or other requirements.

These resources are subject to change without notice. TI grants you permission to use these resources only for development of an application that uses the TI products described in the resource. Other reproduction and display of these resources is prohibited. No license is granted to any other TI intellectual property right or to any third party intellectual property right. TI disclaims responsibility for, and you will fully indemnify TI and its representatives against, any claims, damages, costs, losses, and liabilities arising out of your use of these resources.

TI's products are provided subject to [TI's Terms of Sale](#) or other applicable terms available either on ti.com or provided in conjunction with such TI products. TI's provision of these resources does not expand or otherwise alter TI's applicable warranties or warranty disclaimers for TI products.

TI objects to and rejects any additional or different terms you may have proposed.

Mailing Address: Texas Instruments, Post Office Box 655303, Dallas, Texas 75265
Copyright © 2021, Texas Instruments Incorporated