

3.3V, 50mA Linear Voltage Regulator with Ultra Low Quiescent Current

IFX30081LDV33

Industrial Linear Voltage Regulator

Data Sheet

Rev.1.0, 2015-09-14

Standard Power

IFX30081LDV33



1 Overview

Features

- Ultra Low Quiescent Current of typ. 5.5 μ A
- Wide Input Voltage Range of 2.75 V to 42 V
- Output Current Capability up to 50 mA
- Shutdown Current less than 1 μ A
- Low Drop Out Voltage of typ. 100mV @ 50mA
- Output Current Limit Protection
- Over temperature Shutdown
- Enable Feature
- Available in PG-TSON-10
- Wide temperature range $-40^{\circ}\text{C} \leq T_j \leq 125^{\circ}\text{C}$
- Green Product (RoHS compliant)



PG-TSON-10

Applications

- Battery Operated Systems
- Sensor Supplies
- Smoke and Fire Detectors

Description

The IFX30081LDV33 is a wide input voltage, low drop out voltage and ultra low quiescent current linear voltage regulator.

With a wide input voltage range of 2.75 V to 42 V and ultra low quiescent current of only 5.5 μ A this regulator is perfectly suitable for battery operated systems as well as supplies for sensors.

The IFX30081LDV33 is available in a fixed 3.3V output voltage with an accuracy of 2 % and maximum output current up to 50 mA.

The regulation concept implemented in the IFX30081LDV33 combines fast regulation and very good stability while requiring only a small ceramic capacitor of 1 μ F at the output.

Internal protection features like output current limitation and over temperature shutdown are implemented to protect the device against failures like output short circuit to GND, over-current and over-temperature. The device can be switched on and off by the enable feature. When the device is switched off, the current consumption is less than 1 μ A.

Type	Package	Marking
IFX30081LDV33	PG-TSON-10	381LD33

Overview

Choosing External Components

An input capacitor C_{IN} is recommended to compensate line influences. The output capacitor C_{OUT} is necessary for the stability of the regulating circuit. Stability is guaranteed at values $C_{OUT} \geq 1\mu\text{F}$ and an $\text{ESR} \leq 100\ \Omega$ within the whole operating range.

The qualification of this product is based on JEDEC JESD47 and may reference existing qualification results of similar products. Such referring is justified by structural similarity of the products. The product is not qualified and manufactured according to the requirements of Infineon Technologies with regard to automotive and/or transportation applications. Infineon Technologies administrates a comprehensive quality management system according to the latest version of the ISO9001 and ISO/TS 16949. The most updated certificates of the aforesaid ISO9001 and ISO/TS 16949 are available on the Infineon Technologies webpage <http://www.infineon.com/cms/en/product/technology/quality/>

Pin Configuration

3 Pin Configuration

3.1 Pin Assignment in PG-TSON-10 Package

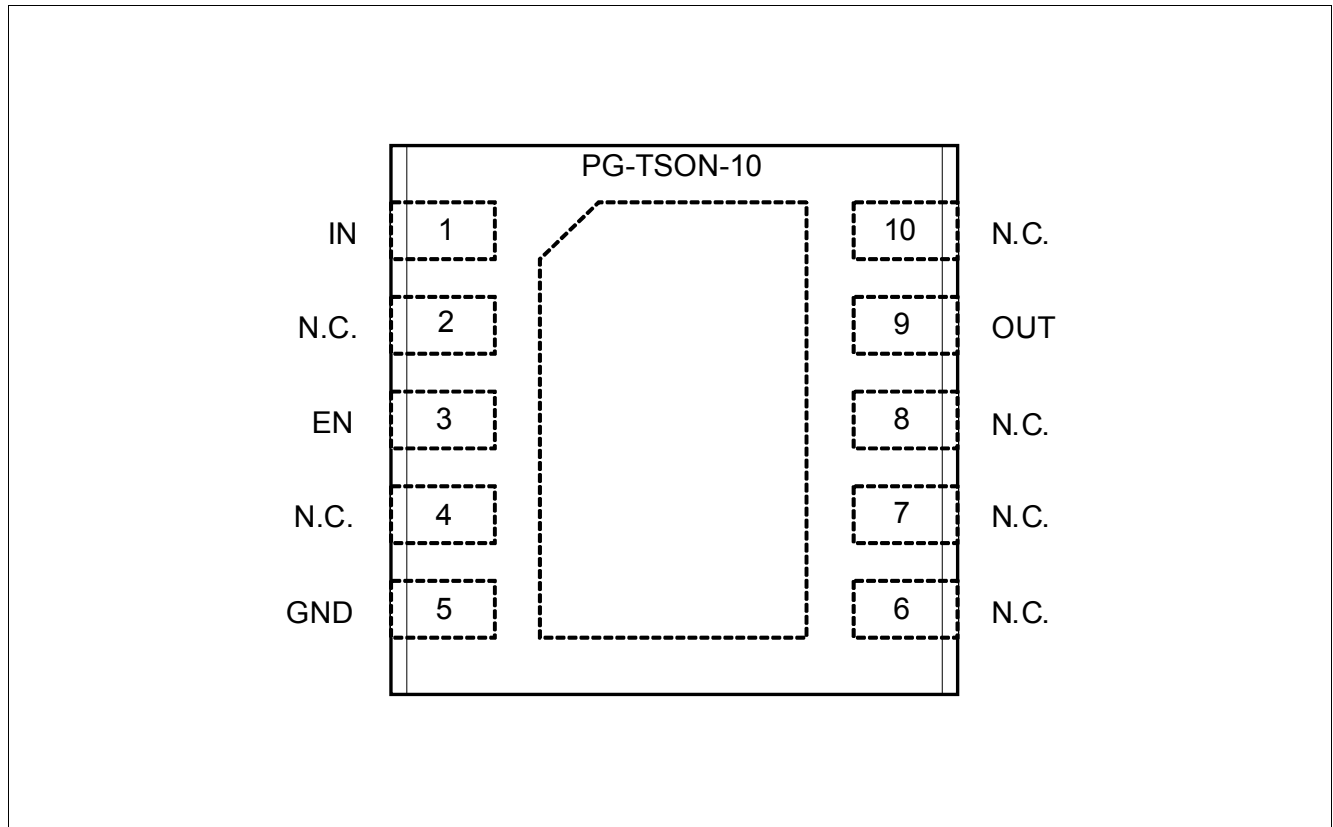

Figure 2 Pin Configuration IFX30081LDV33 in PG-TSON-10 package

3.2 Pin Definitions and Functions in PG-TSON-10 Package

Pin	Symbol	Function
1	IN	Input Compensating line influences by placing a small ceramic capacitor (e.g. 100 nF), to GND, close to the IC terminals is recommended.
2	N.C.	Not Connected
3	EN	Enable (Integrated pull-down resistor) Enable the IC with high level input signal. Disable the IC with low level input signal.
4	N.C.	Not Connected
5	GND	Ground

Pin Configuration

Pin	Symbol	Function
6	N.C.	Not Connected
7	N.C.	Not Connected
8	N.C.	Not Connected
9	OUT	Output Connect an output capacitor C_{OUT} to GND close to the IC's terminals, respecting the values specified for its capacitance and ESR in Table 2 "Functional Range" on Page 8 .
10	N.C.	Not Connected
Exposed Pad	–	Connect to heatsink area. Connect to GND.

Block Diagram

2 Block Diagram

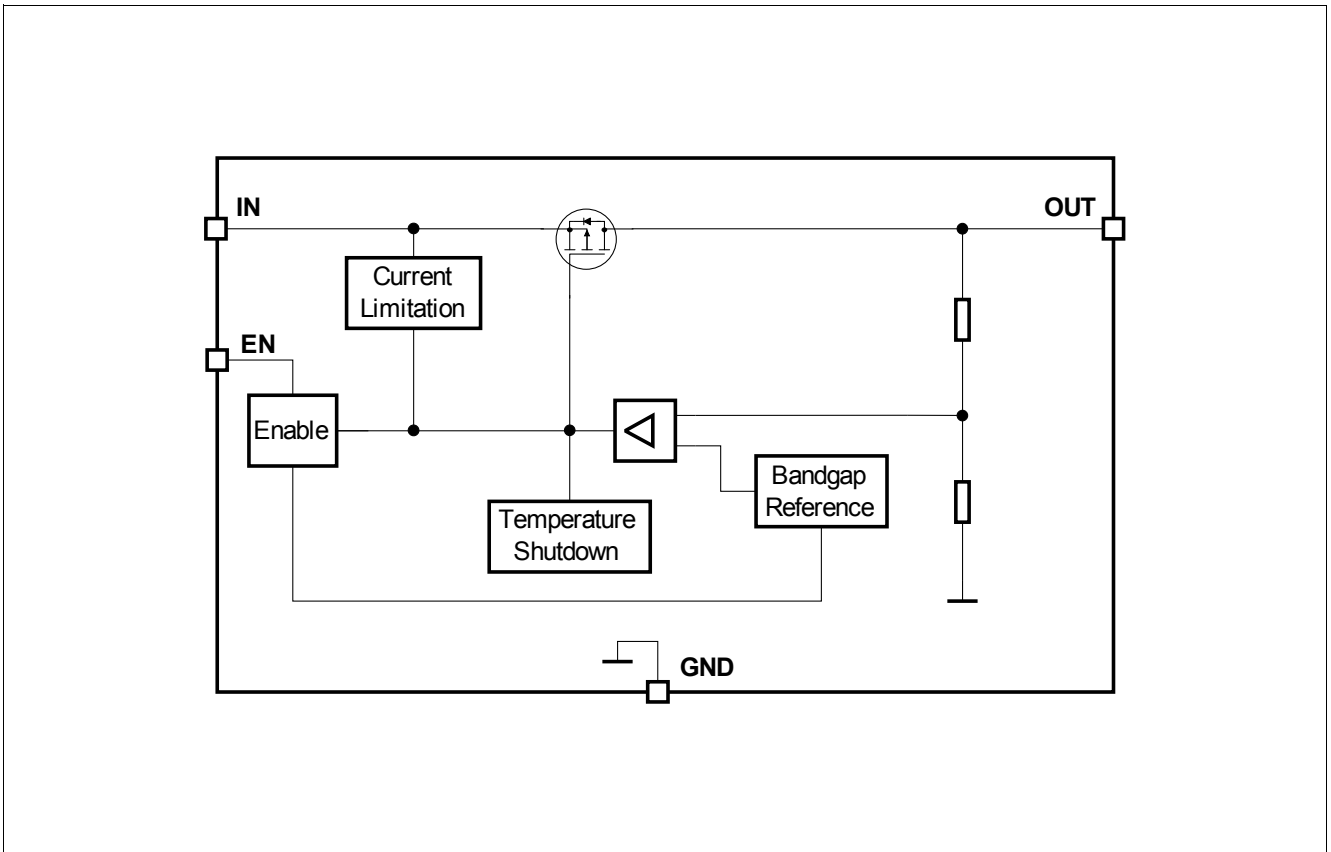

Figure 1 Block Diagram IFX30081LDV33

 General Product Characteristics

4 General Product Characteristics

4.1 Absolute Maximum Ratings

Table 1 Absolute Maximum Ratings¹⁾
 $T_j = -40\text{ °C to }+125\text{ °C}$; all voltages with respect to ground (unless otherwise specified)

Parameter	Symbol	Values			Unit	Note or Test Condition	Number
		Min.	Typ.	Max.			
Voltage Input , Enable EN							
Voltage	$V_{IN}; V_{EN}$	-0.3	–	45	V	–	P_4.1.1
Voltage Output OUT							
Voltage	V_{OUT}	-0.3	–	7	V	–	P_4.1.2
Temperatures							
Junction Temperature	T_j	-40	–	150	°C	–	P_4.1.4
Storage Temperature	T_{stg}	-55	–	150	°C	–	P_4.1.5
ESD Absorption							
ESD Absorption	$V_{ESD,HBM}$	-2	–	2	kV	HBM ²⁾	P_4.1.6
ESD Absorption	$V_{ESD,CDM}$	-750	–	750	V	CDM ³⁾ at all pins	P_4.1.7

1) Not subject to production testing, specified by design.

2) ESD susceptibility, HBM Test according to ANSI/ESDA/JEDEC JS-001 (1.5kOhm, 100pF).

3) ESD susceptibility, Charged Device Model “CDM” according to JEDEC JESD22-C101

Note:

1. Stresses above the ones listed here may cause permanent damage to the device. Exposure to absolute maximum rating conditions for extended periods may affect device reliability.
2. Integrated protection functions are designed to prevent IC destruction under fault conditions described in the data sheet. Fault conditions are considered as “outside” normal operating range. Protection functions are not designed for continuous repetitive operation.

 General Product Characteristics

4.2 Functional Range

Table 2 Functional Range

Parameter	Symbol	Values			Unit	Note or Test Condition	Number
		Min.	Typ.	Max.			
Input Voltage Range	V_{IN}	$V_{OUT,nom} + V_{dr}$	–	42	V	– ¹⁾	P_4.2.1
Extended Input Voltage Range	$V_{IN,ext}$	2.75	–	42	V	– ²⁾	P_4.2.2
Enable Voltage Range	V_{EN}	0	–	42	V	–	P_4.2.3
Output Capacitor	C_{OUT}	1	–	–	μ F	– ³⁾	P_4.2.4
Output Capacitor's ESR	$ESR(C_{OUT})$	–	–	100	Ω	– ⁴⁾	P_4.2.5
Junction temperature	T_j	-40	–	125	$^{\circ}$ C	–	P_4.2.6

- 1) Output current is limited internally and depends on the input voltage, see Electrical Characteristics for more details.
- 2) Between min. value and $V_{OUT,nom} + V_{dr}$: $V_{OUT} = V_{IN} - V_{dr}$. Below min. value: V_{OUT} can drop down to 0 V.
- 3) The minimum output capacitance requirement is applicable for a worst case capacitance tolerance of 30%.
- 4) Relevant ESR value at $f = 10$ kHz.

Note: Within the functional or operating range, the IC operates as described in the circuit description. The electrical characteristics are specified within the conditions given in the Electrical Characteristics table.

General Product Characteristics

4.3 Thermal Resistance

Note: This thermal data was generated in accordance with JEDEC JESD51 standards. For more information, go to www.jedec.org.

Table 3 Thermal Resistance

Parameter	Symbol	Values			Unit	Note or Test Condition	Number
		Min.	Typ.	Max.			
Junction to Case ¹⁾	R_{thJC}	–	13	–	K/W	–	P_4.3.1
Junction to Ambient	R_{thJA}	–	60	–	K/W	2s2p board ²⁾	P_4.3.2
Junction to Ambient	R_{thJA}	–	188	–	K/W	footprint only ³⁾	P_4.3.3
Junction to Ambient	R_{thJA}	–	76	–	K/W	300 mm ² heatsink area on PCB ³⁾	P_4.3.4
Junction to Ambient	R_{thJA}	–	64	–	K/W	600 mm ² heatsink area on PCB ³⁾	P_4.3.5

1) Not subject to production test, specified by design.

2) Specified R_{thJA} value is according to JEDEC JESD51-2,-5,-7 at natural convection on FR4 2s2p board; The product (Chip+Package) was simulated on a 76.2 x 114.3 x 1.5 mm³ board with two inner copper layers (2 x 70µm Cu, 2 x 35µm Cu). Wherever applicable a thermal via array under the exposed pad contacted the first inner copper layer.

3) Specified R_{thJA} value is according to JEDEC JESD51-3 at natural convection on FR4 1s0p board; The product (Chip+Package) was simulated on a 76.2 x 114.3 x 1.5 mm³ board with one inner copper layers (1 x 70µm Cu)

5 Block Description and Electrical Characteristics

5.1 Voltage Regulation

The output voltage V_{OUT} is divided by an internal resistor network. This fractional voltage is compared to an internal voltage reference and drives the pass transistor accordingly.

The control loop stability depends on the output capacitor C_{OUT} , the load current, the chip temperature and the internal circuit design. To ensure stable operation, the output capacitor's capacitance and its equivalent series resistor ESR requirements given in "Functional Range" on Page 8 have to be maintained. For further details please refer to the typical performance graph "Output Capacitor Series Resistor ESR(C_{OUT}) versus Output Current I_{OUT} " on Page 13. Since the output capacitor is used to buffer load steps, it should be sized according to the application's needs.

An input capacitor C_{IN} is not required for stability, but is recommended to compensate line fluctuations. An additional reverse polarity protection diode and a combination of several capacitors for filtering should be used. Connect the capacitors close to the regulator terminals.

In order to prevent overshoots during start-up, a smooth ramping up function is implemented. This ensures almost no overshoots during start-up, mostly independent from load and output capacitance.

Whenever the load current exceeds the specified limit, e.g. in case of a short circuit, the output current is limited and the output voltage decreases.

The over temperature shutdown circuit prevents the IC from immediate destruction under fault conditions (e.g. output continuously short-circuit) by switching off the power stage. After the chip has cooled down, the regulator restarts. This oscillatory thermal behavior causes the junction temperature to exceed the 150° C maximum and significantly reducing the IC's life.

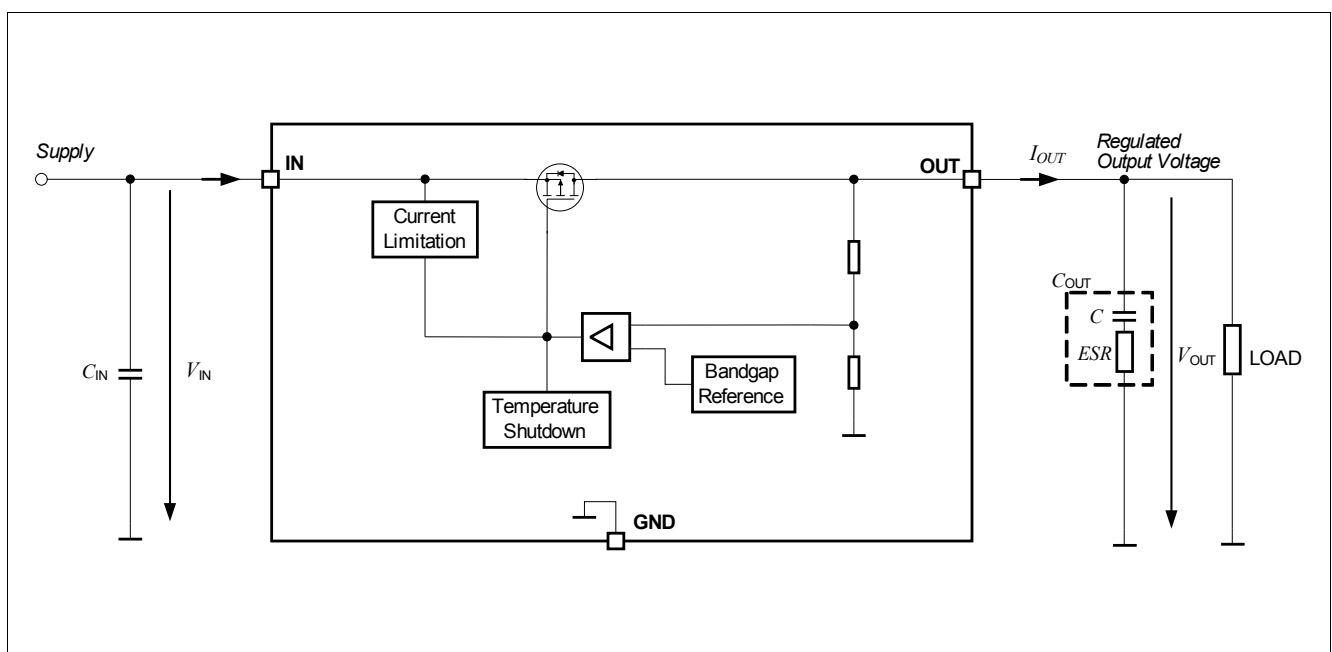

Figure 3 Block Diagram Voltage Regulation

Block Description and Electrical Characteristics

Table 4 Electrical Characteristics

$T_j = -40\text{ }^\circ\text{C}$ to $+125\text{ }^\circ\text{C}$, $V_{IN} = 13.5\text{ V}$ all voltages with respect to ground (unless otherwise specified). Typical values are given at $T_j = 25\text{ }^\circ\text{C}$, $V_{IN} = 13.5\text{ V}$

Parameter	Symbol	Values			Unit	Note or Test Condition	Number
		Min.	Typ.	Max.			
Output Voltage Precision	V_{OUT}	3.23	3.30	3.37	V	$50\text{ }\mu\text{A} \leq I_{OUT} \leq 50\text{ mA}$, $4\text{ V} \leq V_{IN} \leq 28\text{ V}$	P_5.1.2
Output Voltage Precision	V_{OUT}	3.23	3.30	3.37	V	$50\text{ }\mu\text{A} \leq I_{OUT} \leq 25\text{ mA}$, $4 \leq V_{IN} \leq 42\text{ V}$	P_5.1.3
Output Current Limitation	$I_{OUT,lim}$	51	85	120	mA	$0\text{ V} \leq V_{OUT} \leq V_{OUT,nom} - 0.1\text{ V}$	P_5.1.4
Line Regulation steady-state	$\Delta V_{OUT,line}$	-	1	20	mV	$I_{OUT} = 1\text{ mA}$, $6\text{ V} \leq V_{IN} \leq 32\text{ V}$	P_5.1.6
Load Regulation steady-state	$\Delta V_{OUT,load}$	-20	-1	-	mV	$V_{IN} = 6\text{ V}$, $50\text{ }\mu\text{A} \leq I_{OUT} \leq 50\text{ mA}$	P_5.1.7
Dropout Voltage ¹⁾ $V_{dr} = V_{IN} - V_{OUT}$	V_{dr}	-	100	300	mV	$I_{OUT} = 50\text{ mA}$	P_5.1.11
Ripple Rejection ²⁾	PSRR	-	57	-	dB	$I_{OUT} = 50\text{ mA}$, $f_{ripple} = 100\text{ Hz}$, $V_{ripple} = 0.5\text{ V}_{p-p}$	P_5.1.13
Over temperature Shutdown Threshold	$T_{j,sd}$	151	175	-	$^\circ\text{C}$	T_j increasing	P_5.1.14
Over temperature Shutdown Threshold Hysteresis	$T_{j,sdh}$	-	10	-	K	T_j decreasing	P_5.1.15

1) Measured when the output voltage V_{OUT} has dropped 100mV from the nominal value obtained at $V_{IN} = 12\text{ V}$

2) Not subject to production test, guaranteed by design

Block Description and Electrical Characteristics

5.2 Typical Performance Characteristics Voltage Regulation

Typical Performance Characteristics

Output Voltage V_{OUT} versus Junction Temperature T_j

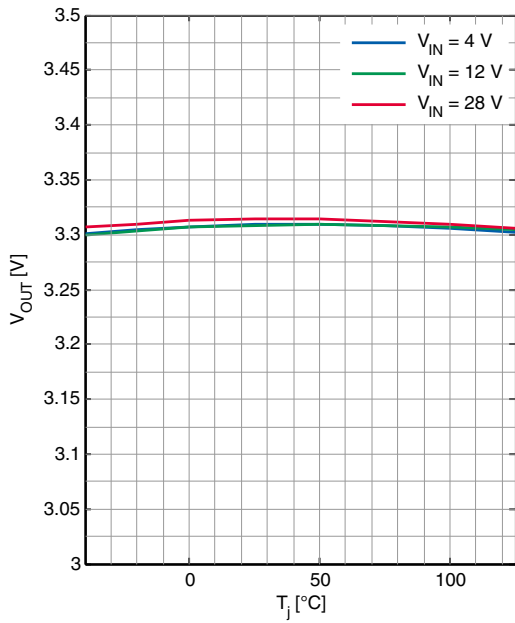

Output Voltage V_{OUT} versus Input Voltage V_{IN}

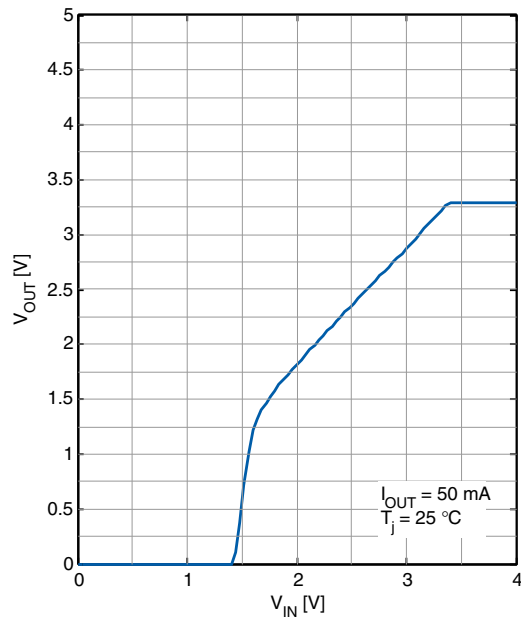

Dropout Voltage V_{dr} versus Junction Temperature T_j

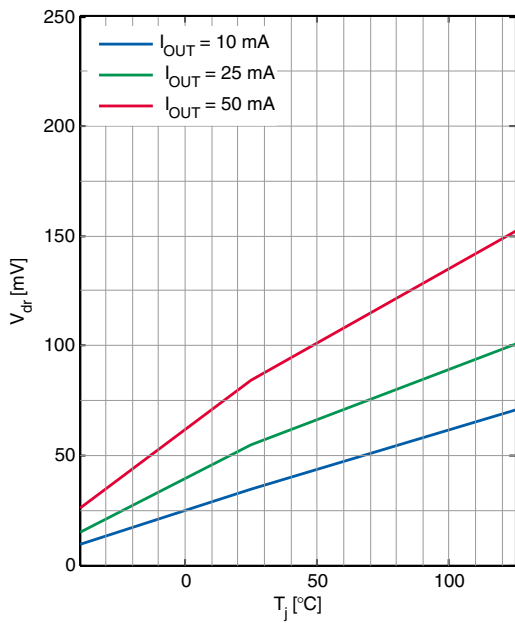

Dropout Voltage V_{dr} versus Output Current I_{OUT}

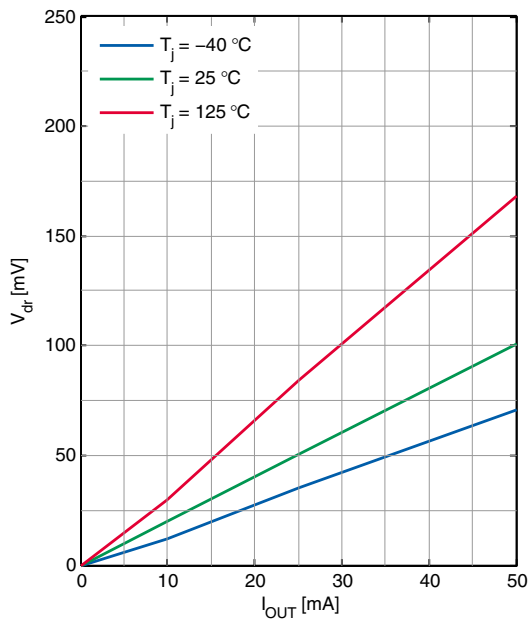

Block Description and Electrical Characteristics

Load Regulation $\Delta V_{OUT,load}$ versus Output Current Change ΔI_{OUT}

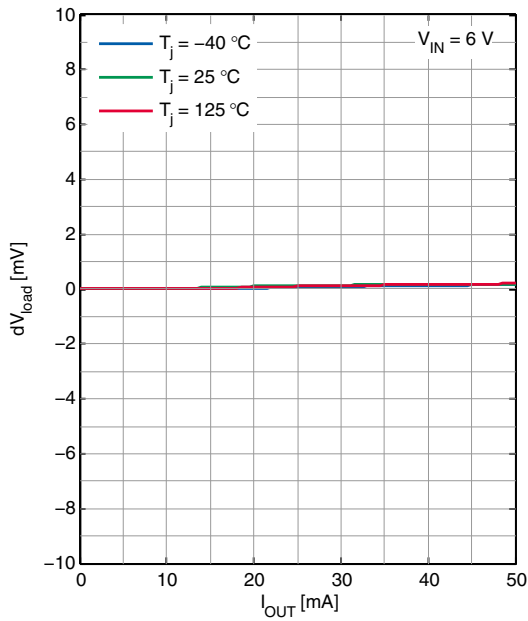

Line Regulation $\Delta V_{OUT,line}$ versus Input Voltage V_{IN}

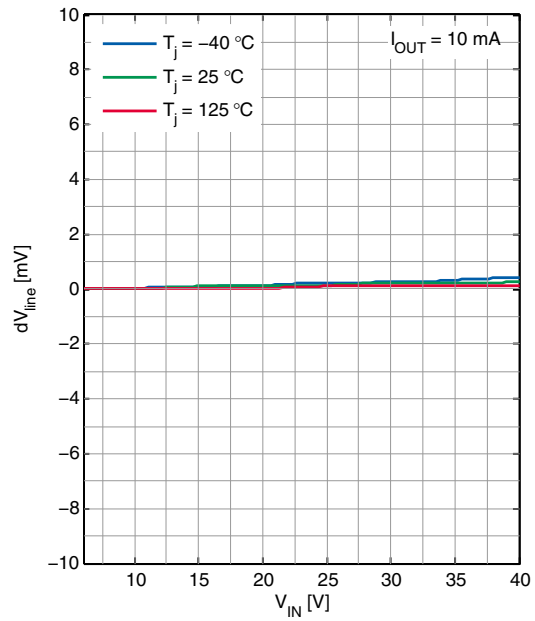

Power Supply Ripple Rejection $PSRR$ versus ripple frequency f_r

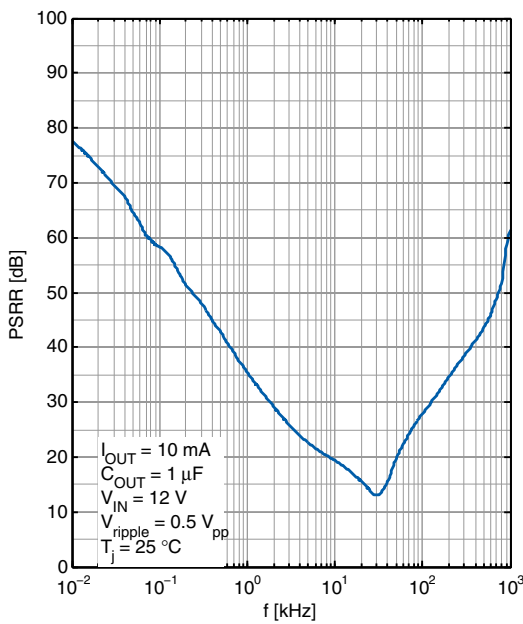

Output Capacitor Series Resistor $ESR(C_{OUT})$ versus Output Current I_{OUT}

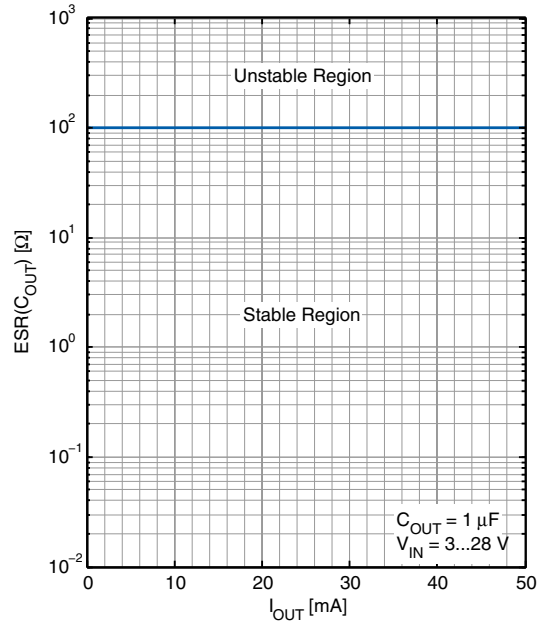

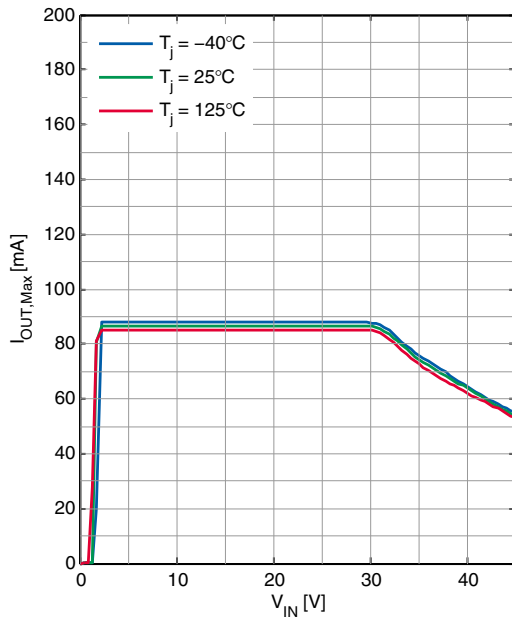
Block Description and Electrical Characteristics**Maximum Output Current $I_{OUT,Max}$ versus
Input Voltage V_{IN}** 

 Block Description and Electrical Characteristics

5.3 Current Consumption

Table 5 Electrical Characteristics Current Consumption IFX30081LDV33

$T_j = -40\text{ °C}$ to $+125\text{ °C}$, $V_{IN} = 13.5\text{ V}$, all voltages with respect to ground (unless otherwise specified). Typical values are given at $T_j = 25\text{ °C}$, $V_{IN} = 13.5\text{ V}$

Parameter	Symbol	Values			Unit	Note or Test Condition	Number
		Min.	Typ.	Max.			
Current Consumption $I_q = I_{IN}$	$I_{q,OFF}$	–	–	1	μA	$V_{EN} \leq 0.4\text{ V}$, $T_j < 105\text{ °C}$	P_5.3.1
Current Consumption $I_q = I_{IN} - I_{OUT}$	I_q	–	5.5	8.5	μA	$I_{OUT} = 50\mu\text{A}$, $T_j = 25\text{ °C}$	P_5.3.2
Current Consumption $I_q = I_{IN} - I_{OUT}$	I_q	–	7	11.5	μA	$I_{OUT} = 50\mu\text{A}$, $T_j < 105\text{ °C}$	P_5.3.3
Current Consumption $I_q = I_{IN} - I_{OUT}$	I_q	–	7.5	12.5	μA	$I_{OUT} = 50\mu\text{A}$, $T_j < 125\text{ °C}$	P_5.3.4
Current Consumption $I_q = I_{IN} - I_{OUT}$	I_q	–	7.5	12.5	μA	$I_{OUT} = 50\text{ mA}$, $T_j < 125\text{ °C}$	P_5.3.5

Block Description and Electrical Characteristics

5.4 Typical Performance Characteristics Current Consumption

Typical Performance Characteristics

Current Consumption in OFF mode $I_{q,OFF}$ versus Junction Temperature T_j

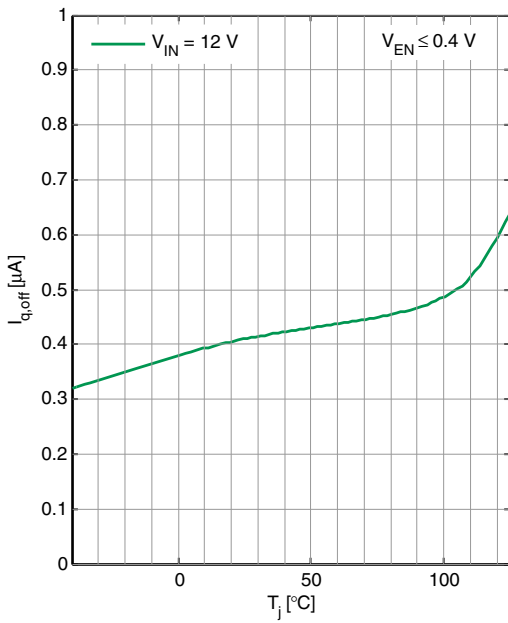

Current Consumption in OFF mode $I_{q,OFF}$ versus Input Voltage V_{IN}

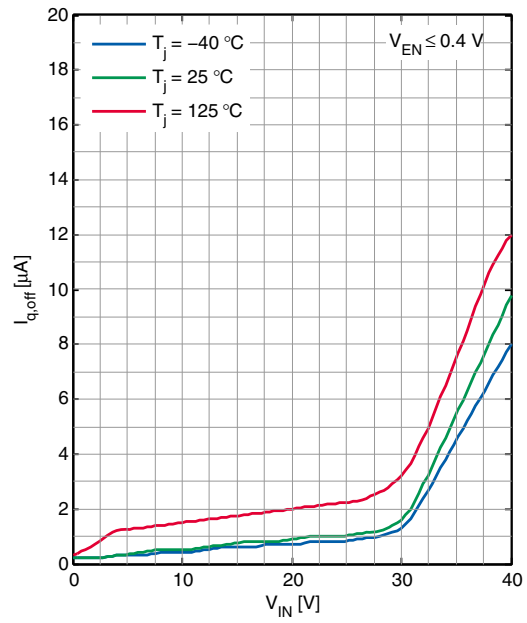

Current Consumption I_q versus Input Voltage V_{IN}

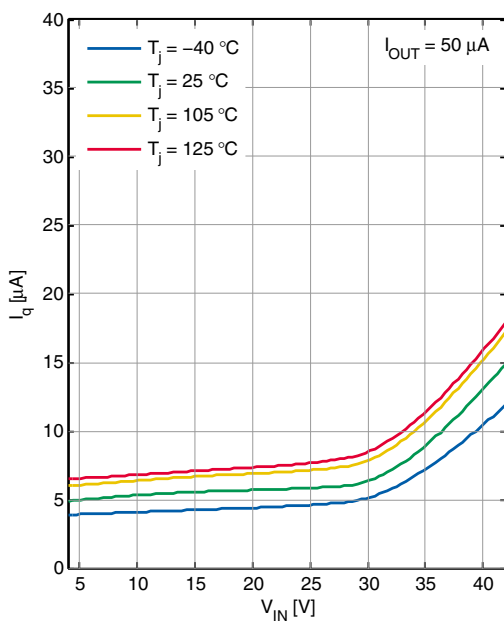

Current Consumption I_q versus Input Voltage V_{IN}

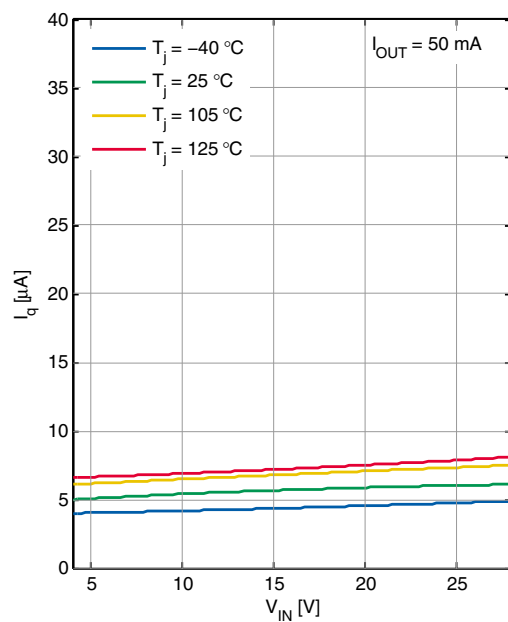

Block Description and Electrical Characteristics

Current Consumption I_q versus
Junction Temperature T_j

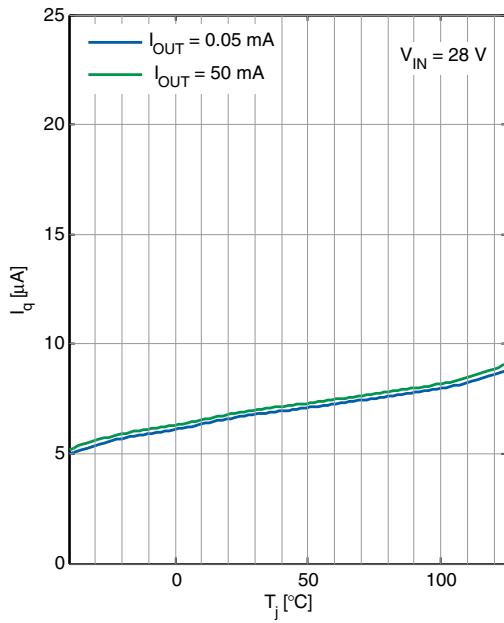

Current Consumption I_q versus
Output Current I_{OUT}

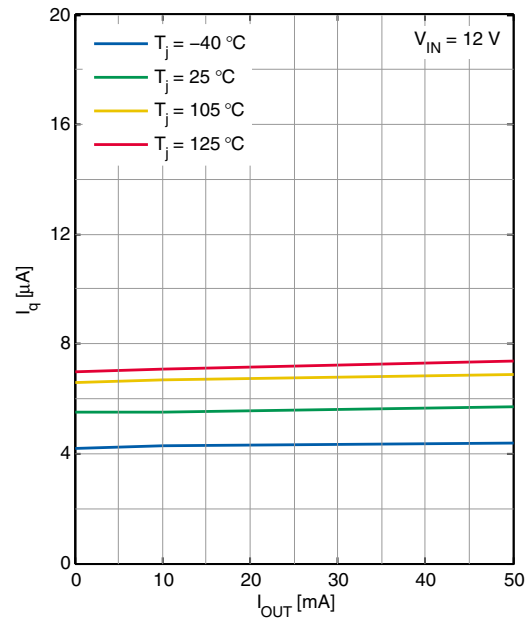

Block Description and Electrical Characteristics

5.5 Enable

The device IFX30081LDV33 can be switched on and off by the Enable feature: Connect a HIGH level as specified below (e.g. the battery voltage) to pin EN to enable the device; connect a LOW level as specified below (e.g. GND) to shut it down. The enable has a build in hysteresis to avoid toggling between ON/OFF state, if signals with slow slopes are applied to the enable input.

Table 6 Electrical Characteristics Enable

$T_j = -40\text{ °C}$ to $+125\text{ °C}$, $V_{IN} = 13.5\text{ V}$ all voltages with respect to ground (unless otherwise specified). Typical values are given at $T_j = 25\text{ °C}$, $V_{IN} = 13.5\text{ V}$

Parameter	Symbol	Values			Unit	Note or Test Condition	Number
		Min.	Typ.	Max.			
High Level Enable Input Voltage	$V_{EN,H}$	2	–	–	V	V_{OUT} settled	P_5.5.1
Low Level Enable Input Voltage	$V_{EN,L}$	–	–	0.8	V	$V_{OUT} \leq 0.1\text{ V}$	P_5.5.2
High Level Input Current	$I_{EN,H}$	–	–	4	μA	$V_{EN} = 5\text{ V}$	P_5.5.4
Enable Internal Pull-down Resistor	R_{EN}	1.25	2	3.5	$\text{M}\Omega$		P_5.5.6

Block Description and Electrical Characteristics

5.6 Typical Performance Characteristics Enable

Typical Performance Characteristics

Enable Input Voltage V_{EN} versus
Junction Temperature T_j

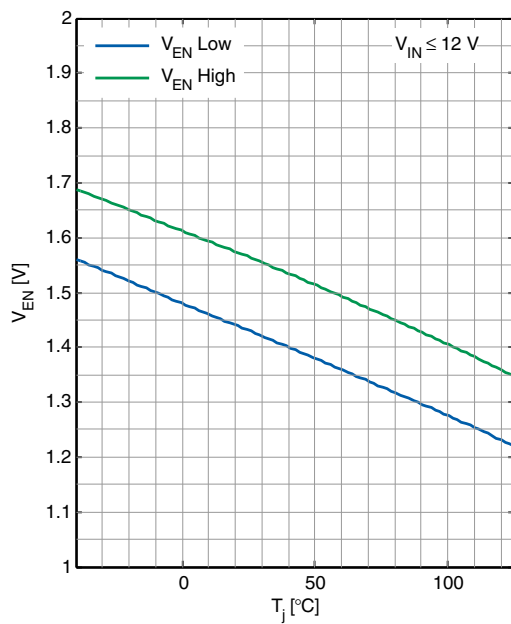

Enable Input Current I_{EN} versus
Enable Input Voltage V_{EN}

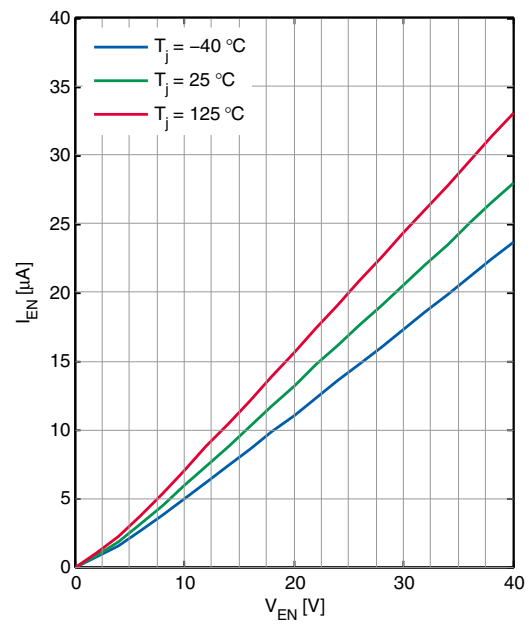

Application Information

6 Application Information

Note: The following information is given as a hint for the implementation of the device only and shall not be regarded as a description or warranty of a certain functionality, condition or quality of the device.

6.1 Application Diagram

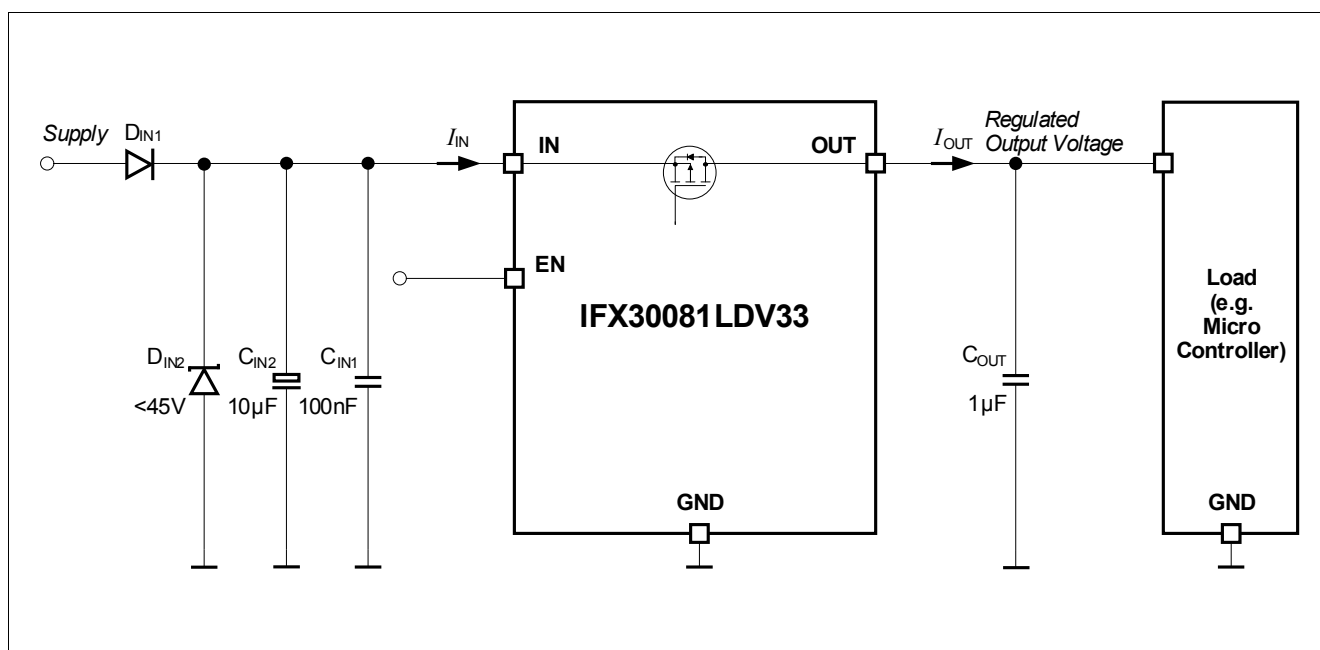

Figure 4 Application Diagram IFX30081LDV33

6.2 Selection of External Components

6.2.1 Input Pin

The typical input circuitry for a linear voltage regulator is shown in the application diagram above i.e. [Figure 4](#). A ceramic capacitor at the input, in the range of 100 nF to 470 nF, is recommended to filter out the high frequency disturbances imposed by the line. The capacitor must be placed very close to the input pin of the linear voltage regulator on the PCB.

An aluminium electrolytic capacitor in the range of 10 μF to 470 μF is recommended as an input buffer to smooth out high energy pulses. The capacitor should be placed close to the input pin of the linear voltage regulator on the PCB.

An overvoltage suppressor diode can be used to further suppress any high voltage beyond the maximum rating of the linear voltage regulator and protect the device against any damage due to over-voltage. The external components at the input are not mandatory for the operation of the voltage regulator, but they are recommended in case of possible external disturbances.

Application Information

6.2.2 Output Pin

An output capacitor is mandatory for the stability of linear voltage regulators. The requirement of the output capacitor is given in [“Functional Range” on Page 8](#). The graph [“Output Capacitor Series Resistor ESR\(C_{OUT}\) versus Output Current I_{OUT}” on Page 13](#) shows the stable operation range of the device. IFX30081LDV33 is designed to be stable with extremely low ESR capacitors. The output capacitor should be placed as close as possible to the regulator’s output and GND pins, on the same side of the PCB as the regulator itself.

In case of rapid transients of input voltage or load current, the capacitance should be dimensioned in accordance and verified in the real application to make sure that the stability requirements are fulfilled.

6.3 Thermal Considerations

Knowing the input voltage, the output voltage and the load profile of the application, the total power dissipation can be calculated:

(6.1)

$$P_D = (V_{IN} - V_{OUT}) \times I_{OUT} + V_{IN} \times I_q$$

where,

P_D : Continuous power dissipation

V_{IN} : Input Voltage

V_{OUT} : Output Voltage

I_{OUT} : Output Current

I_q : Quiescent Current

The maximum acceptable thermal resistance R_{thJA} can then be calculated as:

(6.2)

$$R_{thJA, \max} = \frac{T_{j, \max} - T_a}{P_D}$$

where,

$T_{j, \max}$: Maximum allowed junction temperature

T_a : Ambient temperature of the application

Based on the above calculation the proper PCB type and the necessary heat sink area can be determined with reference to the specification in [“Thermal Resistance” on Page 9](#).

Application Information

Example

Application Conditions:

$$V_{IN} = 12 \text{ V}$$

$$V_{OUT} = 3.3 \text{ V}$$

$$I_{OUT} = 30 \text{ mA}$$

$$T_a = 85 \text{ }^\circ\text{C}$$

Based on the equation (6.1), we can calculate the power dissipation for the above application example.

$$P_D = (12 - 3.3) \times 0.03 + 12 \times 0.0115 = 0.261 + 0.138 = 0.4 \text{ W}$$

According to equation (6.2), $R_{thJA,max}$ can be calculated as $(125^\circ\text{C} - 85^\circ\text{C})/0.4 = 40/0.4 = 100\text{K/W}$

As a result, for the above application example the PCB design must ensure a thermal resistance lower than 100K/W. According to **“Thermal Resistance” on Page 9**, at least 300mm² heatsink area is needed on a FR4 1s0p PCB for this application.

6.4 Reverse Polarity Protection

IFX30081LDV33 is not self protected against reverse polarity faults. To protect the device against negative supply voltage, an external reverse polarity diode is needed. The absolute maximum ratings of the device as specified in **“Absolute Maximum Ratings” on Page 7** must be kept.

6.5 Further Application Information

For further information please refer to <http://www.infineon.com>

7 Package Outlines

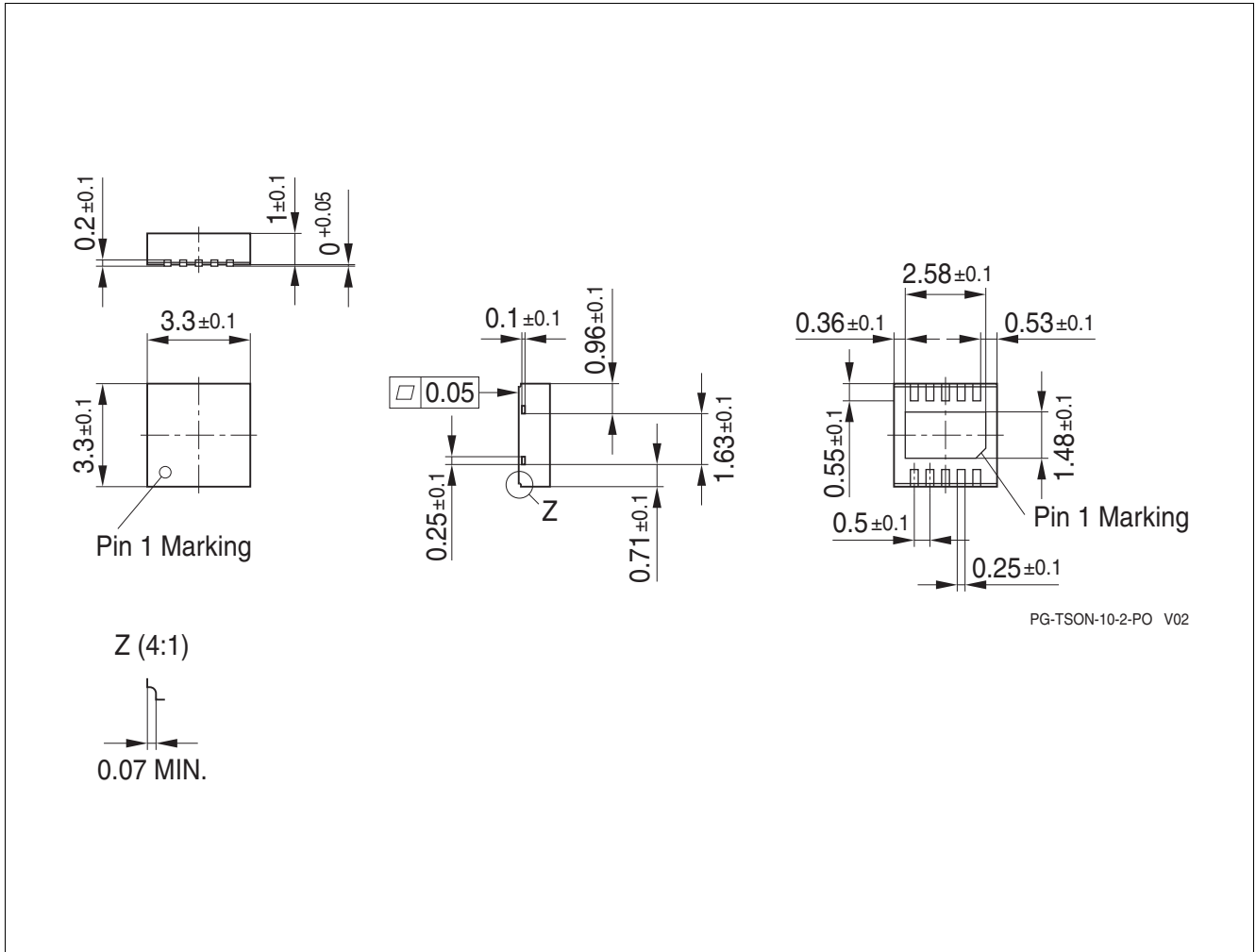

Figure 5 PG-TSON-10 (IFX30081LDV33) Package Outline

Package Outlines

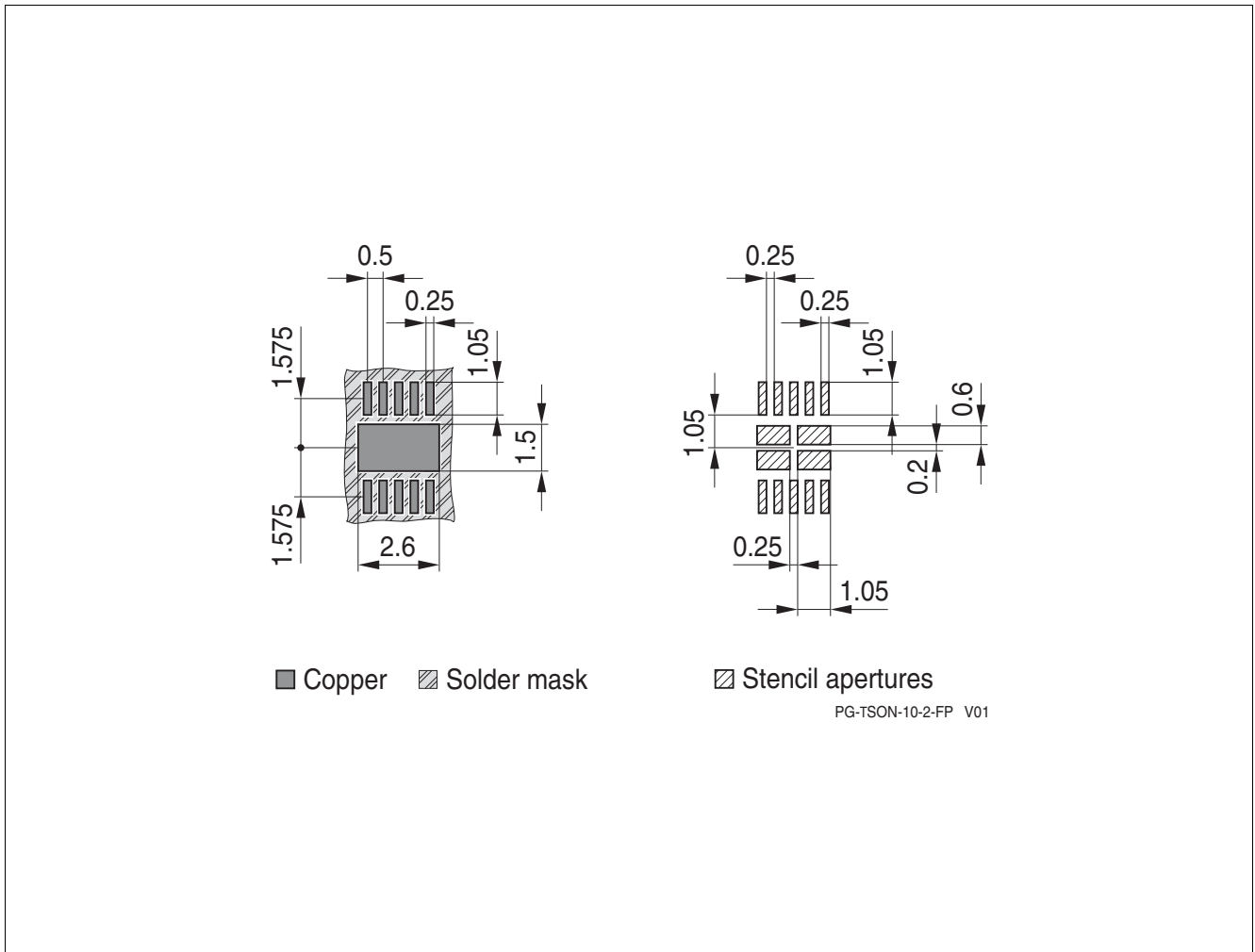

Figure 6 PG-TSON-10 (IFX30081LDV33) Package Footprint

Green Product (RoHS compliant)

To meet the world-wide customer requirements for environmentally friendly products and to be compliant with government regulations the device is available as a green product. Green products are RoHS-Compliant (i.e Pb-free finish on leads and suitable for Pb-free soldering according to IPC/JEDEC J-STD-020).

For further information on alternative packages, please visit our website:
<http://www.infineon.com/packages>.

Dimensions in mm

Revision History**8 Revision History**

Revision	Date	Changes
1.0	2015-09-14	Data sheet - Initial Release

Trademarks of Infineon Technologies AG

AURIX™, C166™, CanPAK™, CIPOST™, CIPURSE™, CoolGaN™, CoolMOS™, CoolSET™, CoolSiC™, CORECONTROL™, CROSSAVE™, DAVE™, DI-POL™, DrBLADE™, EasyPIM™, EconoBRIDGE™, EconoDUAL™, EconoPACK™, EconoPIM™, EiceDRIVER™, eupec™, FCOS™, HITFET™, HybridPACK™, ISOFACE™, IsoPACK™, i-Wafer™, MIPAQ™, ModSTACK™, my-d™, NovalithIC™, OmniTune™, OPTIGA™, OptiMOS™, ORIGA™, POWERCODE™, PRIMARION™, PrimePACK™, PrimeSTACK™, PROFET™, PRO-SIL™, RASIC™, REAL3™, ReverSave™, SatRIC™, SIEGET™, SIPMOS™, SmartLEWIS™, SOLID FLASH™, SPOC™, TEMPFET™, thinQ!™, TRENCHSTOP™, TriCore™.

Other Trademarks

Advance Design System™ (ADS) of Agilent Technologies, AMBA™, ARM™, MULTI-ICE™, KEIL™, PRIMECELL™, REALVIEW™, THUMB™, µVision™ of ARM Limited, UK. ANSI™ of American National Standards Institute. AUTOSAR™ of AUTOSAR development partnership. Bluetooth™ of Bluetooth SIG Inc. CAT-iq™ of DECT Forum. COLOSSUS™, FirstGPS™ of Trimble Navigation Ltd. EMV™ of EMVCo, LLC (Visa Holdings Inc.). EPCOS™ of Epcos AG. FLEXGO™ of Microsoft Corporation. HYPERTERMINAL™ of Hilgraeve Incorporated. MCS™ of Intel Corp. IEC™ of Commission Electrotechnique Internationale. IrDA™ of Infrared Data Association Corporation. ISO™ of INTERNATIONAL ORGANIZATION FOR STANDARDIZATION. MATLAB™ of MathWorks, Inc. MAXIM™ of Maxim Integrated Products, Inc. MICROTEC™, NUCLEUS™ of Mentor Graphics Corporation. MIPI™ of MIPI Alliance, Inc. MIPS™ of MIPS Technologies, Inc., USA. muRata™ of MURATA MANUFACTURING CO., MICROWAVE OFFICE™ (MWO) of Applied Wave Research Inc., OmniVision™ of OmniVision Technologies, Inc. Openwave™ of Openwave Systems Inc. RED HAT™ of Red Hat, Inc. RFMD™ of RF Micro Devices, Inc. SIRIUS™ of Sirius Satellite Radio Inc. SOLARIS™ of Sun Microsystems, Inc. SPANSION™ of Spansion LLC Ltd. Symbian™ of Symbian Software Limited. TAIYO YUDEN™ of Taiyo Yuden Co. TEAKLITE™ of CEVA, Inc. TEKTRONIX™ of Tektronix Inc. TOKO™ of TOKO KABUSHIKI KAISHA TA. UNIX™ of X/Open Company Limited. VERILOG™, PALLADIUM™ of Cadence Design Systems, Inc. VLYNQ™ of Texas Instruments Incorporated. VXWORKS™, WIND RIVER™ of WIND RIVER SYSTEMS, INC. ZETEX™ of Diodes Zetex Limited.

Trademarks Update 2014-07-17

www.infineon.com

Edition 2015-09-14

Published by

**Infineon Technologies AG
81726 Munich, Germany**

© 2014 Infineon Technologies AG.

All Rights Reserved.

Do you have a question about any aspect of this document?

Email: erratum@infineon.com

**Document reference
Doc_Number**

Legal Disclaimer

The information given in this document shall in no event be regarded as a guarantee of conditions or characteristics. With respect to any examples or hints given herein, any typical values stated herein and/or any information regarding the application of the device, Infineon Technologies hereby disclaims any and all warranties and liabilities of any kind, including without limitation, warranties of non-infringement of intellectual property rights of any third party.

Information

For further information on technology, delivery terms and conditions and prices, please contact the nearest Infineon Technologies Office (www.infineon.com).

Warnings

Due to technical requirements, components may contain dangerous substances. For information on the types in question, please contact the nearest Infineon Technologies Office. The Infineon Technologies component described in this Data Sheet may be used in life-support devices or systems and/or automotive, aviation and aerospace applications or systems only with the express written approval of Infineon Technologies, if a failure of such components can reasonably be expected to cause the failure of that life-support automotive, aviation and aerospace device or system or to affect the safety or effectiveness of that device or system. Life support devices or systems are intended to be implanted in the human body or to support and/or maintain and sustain and/or protect human life. If they fail, it is reasonable to assume that the health of the user or other persons may be endangered.