

MSC080SMA120B Silicon Carbide N-Channel Power MOSFET

1 Product Overview

The silicon carbide (SiC) power MOSFET product line from Microsemi increases the performance over silicon MOSFET and silicon IGBT solutions while lowering the total cost of ownership for high-voltage applications. The MSC080SMA120B device is a 1200 V, 80 mΩ SiC MOSFET in a TO-247 package.

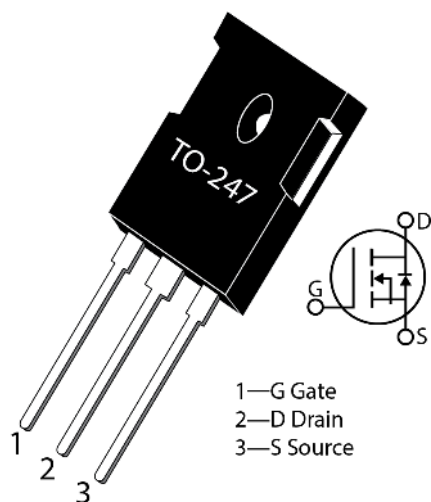

1.1 Features

The following are key features of the MSC080SMA120B device:

- Low capacitances and low gate charge
- Fast switching speed due to low internal gate resistance (ESR)
- Stable operation at high junction temperature, $T_{j(max)} = 175\text{ °C}$
- Fast and reliable body diode
- Superior avalanche ruggedness
- RoHS compliant

1.2 Benefits

The following are benefits of the MSC080SMA120B device:

- High efficiency to enable lighter, more compact system
- Simple to drive and easy to parallel
- Improved thermal capabilities and lower switching losses
- Eliminates the need for external freewheeling diode
- Lower system cost of ownership

1.3 Applications

The MSC080SMA120B device is designed for the following applications:

- PV inverter, converter, and industrial motor drives
- Smart grid transmission and distribution
- Induction heating and welding
- H/EV powertrain and EV charger
- Power supply and distribution

2 Device Specifications

This section shows the device specifications for the MSC080SMA120B device.

2.1 Absolute Maximum Ratings

The following table shows the absolute maximum ratings for the MSC080SMA120B device.

Table 1 • Absolute Maximum Ratings

Symbol	Parameter	Ratings	Unit
V _{DSS}	Drain source voltage	1200	V
I _D	Continuous drain current at T _c = 25 °C	37	A
	Continuous drain current at T _c = 100 °C	26	
I _{DM}	Pulsed drain current ¹	91	
V _{GS}	Gate-source voltage	23 to -10	V
P _D	Total power dissipation at T _c = 25 °C	200	W
	Linear derating factor	1.33	

Note:

1. Repetitive rating: pulse width and case temperature limited by maximum junction temperature.

The following table shows the thermal and mechanical characteristics of the MSC080SMA120B device.

Table 2 • Thermal and Mechanical Characteristics

Symbol	Characteristic	Min	Typ	Max	Unit
R _{θJC}	Junction-to-case thermal resistance		0.50	0.75	°C/W
T _J	Operating junction temperature	-55		175	°C
T _{STG}	Storage temperature	-55		150	
T _L	Soldering temperature for 10 seconds (1.6 mm from case)			260	
	Mounting torque, 6-32 or M3 screw			10	lbf-in
					1.1
Wt	Package weight		0.22		oz
			6.2		g

2.2 Electrical Performance

The following table shows the static characteristics for the MSC080SMA120B device. T_J = 25 °C unless otherwise specified.

Table 3 • Static Characteristics

Symbol	Characteristic	Test Conditions	Min	Typ	Max	Unit
V _{(BR) DSS}	Drain-source breakdown voltage	V _{GS} = 0 V, I _D = 100 μA	1200			V

Symbol	Characteristic	Test Conditions	Min	Typ	Max	Unit
$R_{DS(on)}$	Drain-source on resistance ¹	$V_{GS} = 20\text{ V}, I_D = 15\text{ A}$		80	100	m Ω
$V_{GS(th)}$	Gate-source threshold voltage	$V_{GS} = V_{DS}, I_D = 1\text{ mA}$	1.8	2.8		V
$\Delta V_{GS(th)}/\Delta T_J$	Threshold voltage coefficient	$V_{GS} = V_{DS}, I_D = 1\text{ mA}$		-4.5		mV/ $^{\circ}\text{C}$
I_{DSS}	Zero gate voltage drain current	$V_{DS} = 1200\text{ V}, V_{GS} = 0\text{ V}$			100	μA
		$V_{DS} = 1200\text{ V}, T_J = 125\text{ }^{\circ}\text{C}$ $V_{GS} = 0\text{ V}$			500	
I_{GSS}	Gate-source leakage current	$V_{GS} = 20\text{ V} / -10\text{ V}$			± 100	nA

Note:

1. Pulse test: pulse width < 380 μs , duty cycle < 2%.

The following table shows the dynamic characteristics for the MSC080SMA120B device. $T_J = 25\text{ }^{\circ}\text{C}$ unless otherwise specified.

Table 4 • Dynamic Characteristics

Symbol	Characteristic	Test Conditions	Min	Typ	Max	Unit
C_{iss}	Input capacitance	$V_{GS} = 0\text{ V}$		838		pF
C_{rss}	Reverse transfer capacitance	$V_{DD} = 1000\text{ V}$ $V_{AC} = 25\text{ mV}$		9		
C_{oss}	Output capacitance	$f = 1\text{ MHz}$		84		
Q_g	Total gate charge	$V_{GS} = -5\text{ V}/20\text{ V}$		64		nC
Q_{gs}	Gate-source charge	$V_{DD} = 800\text{ V}$ $I_D = 15\text{ A}$		12		
Q_{gd}	Gate-drain charge			19		
$t_{d(on)}$	Turn-on delay time	$V_{DD} = 800\text{ V}$ $V_{GS} = -5\text{ V}/20\text{ V}$		5		ns
t_r	Current rise time	$I_D = 15\text{ A}$		4		
$t_{d(off)}$	Turn-off delay time	$R_{G(ext)} = 4\text{ }\Omega^{\dagger}$		21		
t_f	Current fall time	Freewheeling diode = MSC080SMA120B ($V_{GS} = -5\text{ V}$)		15		
E_{on}	Turn-on switching energy ²			319		μJ
E_{off}	Turn-off switching energy			52		
$t_{d(on)}$	Turn-on delay time	$V_{DD} = 800\text{ V}$ $V_{GS} = -5\text{ V}/20\text{ V}$		4		ns
t_r	Current rise time	$I_D = 15\text{ A}$		4		
$t_{d(off)}$	Turn-off delay time	$R_{G(ext)} = 4\text{ }\Omega^{\dagger}$		24		
t_f	Current fall time	Freewheeling diode = MSC015SDA120B		19		
E_{on}	Turn-on switching energy ²			199		μJ
E_{off}	Turn-off switching energy			50		
ESR	Equivalent series resistance	$f = 1\text{ MHz}, 25\text{ mV}, \text{ drain short}$		1.9		Ω
SCWT	Short circuit withstand time	$V_{DS} = 960\text{ V}, V_{GS} = 20\text{ V},$		3		μs
E_{AS}	Avalanche energy, single pulse	$V_{DS} = 150\text{ V}, I_D = 15\text{ A},$		1000		mJ

Notes:

1. R_G is total gate resistance excluding internal gate driver impedance.
2. E_{on} includes energy of the freewheeling diode.

2.3 Body Diode Characteristics

The following table shows the body diode characteristics for the MSC080SMA120B device. $T_J = 25\text{ }^\circ\text{C}$ unless otherwise specified.

Table 5 • Body Diode Characteristics

Symbol	Parameter	Test Conditions	Min	Typ	Max	Unit
V_{SD}	Diode forward voltage	$I_{SD} = 15\text{ A}$, $V_{GS} = 0\text{ V}$		4.0		V
V_{SD}	Diode forward voltage	$I_{SD} = 15\text{ A}$, $V_{GS} = -5\text{ V}$		4.2		V
t_{rr}	Reverse recovery time	$I_{SD} = 15\text{ A}$, $V_{GS} = -5\text{ V}$		34		ns
Q_{rr}	Reverse recovery charge	$V_{DD} = 800\text{ V}$ $dI/dt = -1000\text{ A}/\mu\text{s}$		200		nC
I_{rrm}	Reverse recovery current			6.5		A

2.4 Typical Performance Curves

This section shows the typical performance curves for the MSC080SMA120B device.

Figure 1 • Drain Current vs. Drain-to-Source Voltage

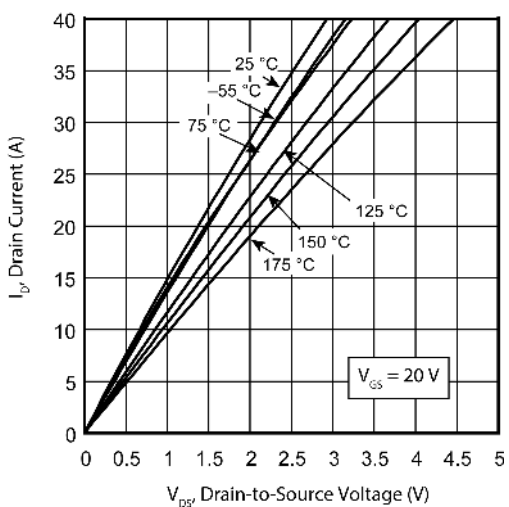

Figure 2 • Drain Current vs. Drain-to-Source Voltage

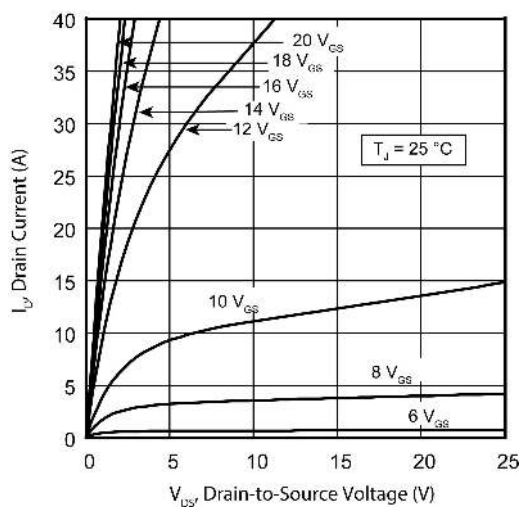

Figure 3 • Drain Current vs. Drain-to-Source Voltage

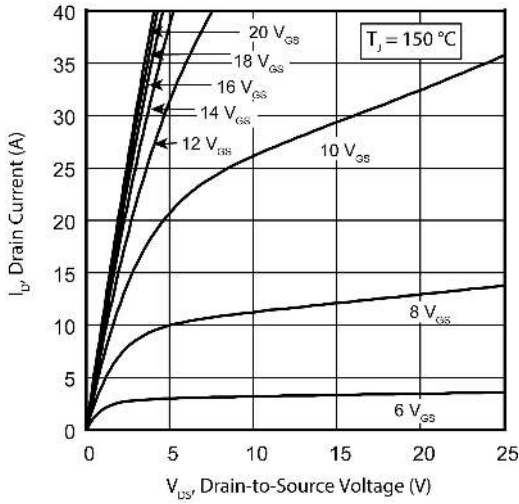

Figure 4 • Drain Current vs. Drain-to-Source Voltage

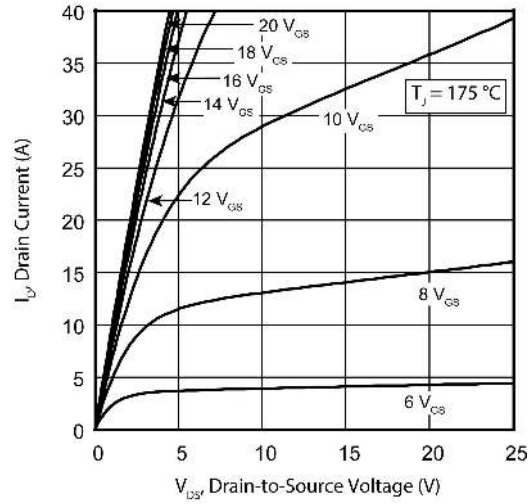

Figure 5 • RDS(on) vs. Junction Temperature

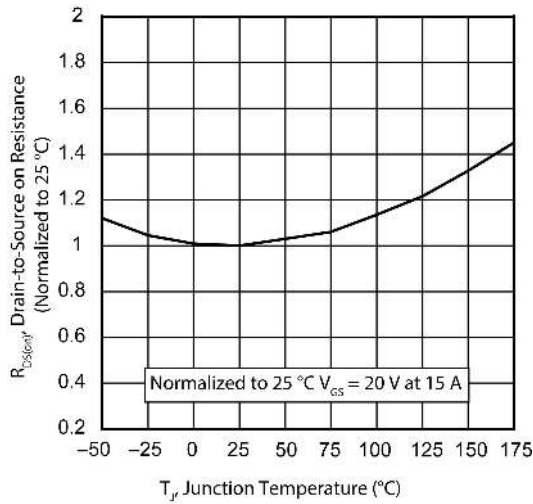

Figure 6 • Gate Charge Characteristics

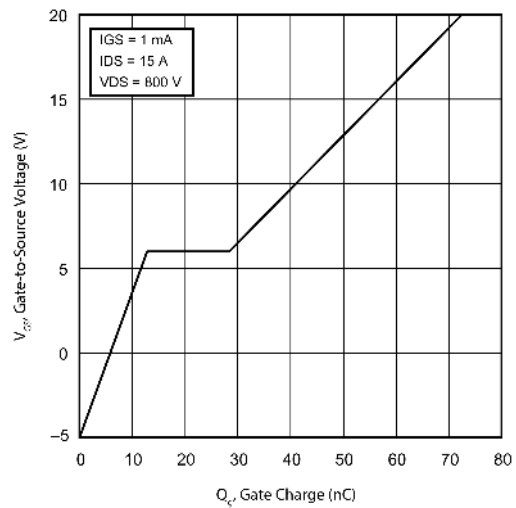

Figure 7 • Capacitance vs. Drain-to-Source Voltage

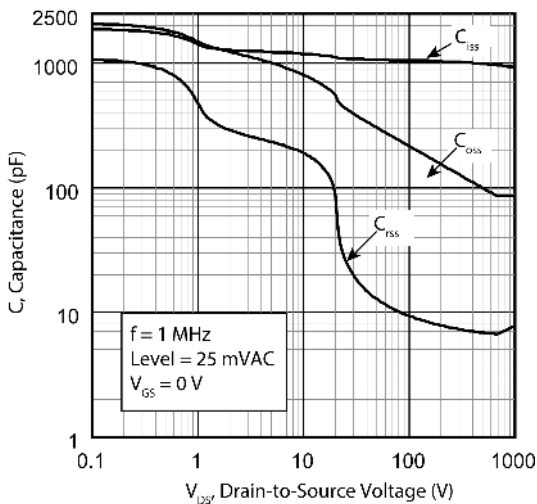

Figure 8 • IDM vs. Gate-to-Source Voltage

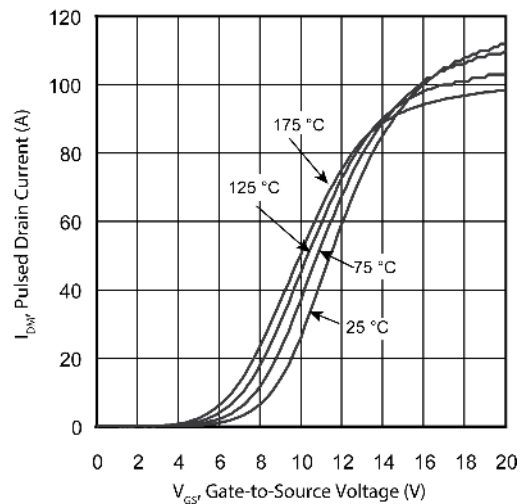

Figure 9 • IDM vs. VDS Third Quadrant Conduction

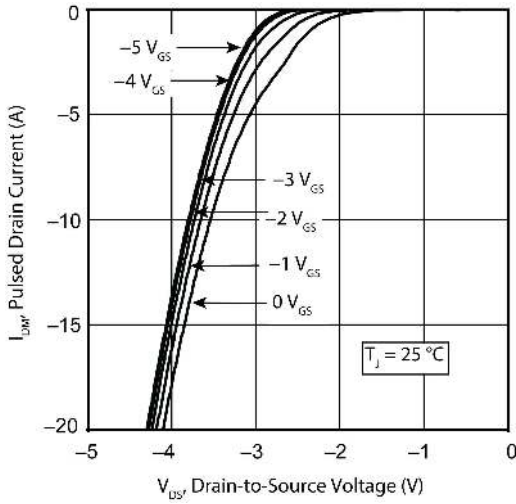

Figure 10 • IDM vs. VDS Third Quadrant Conduction

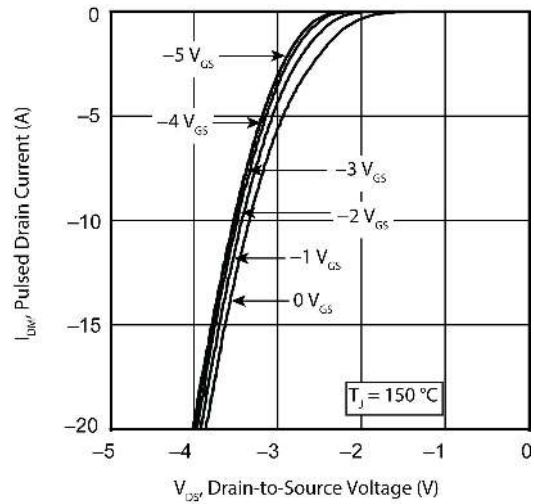

Figure 11 • VGS(th) vs. Junction Temp.

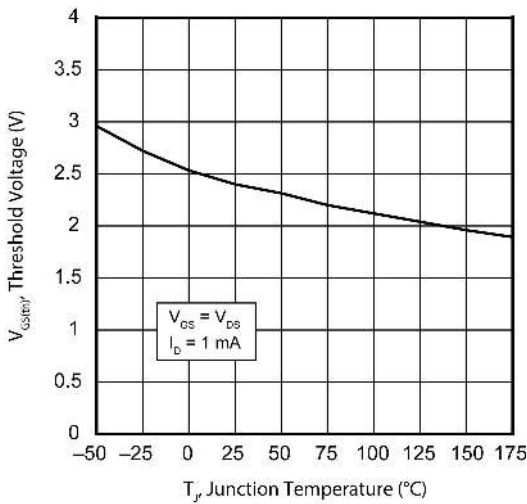

Figure 12 • Forward Safe Operating Area

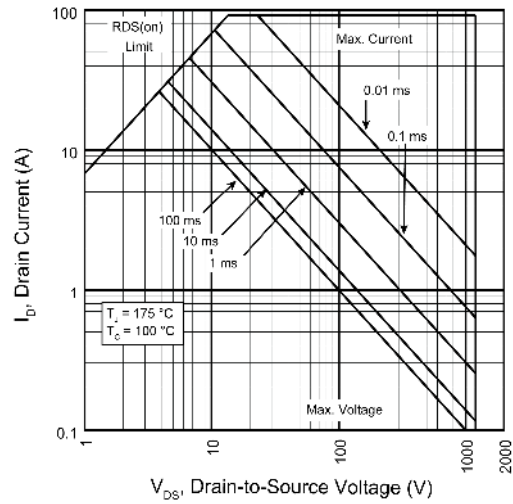
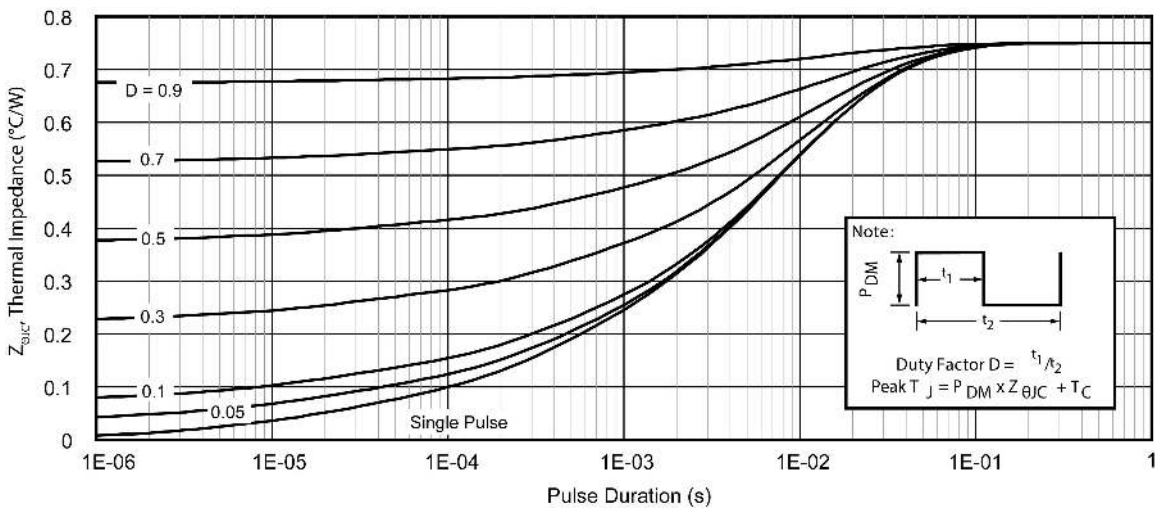

Figure 13 • Maximum Transient Thermal Impedance



3 Package Specification

This section shows the package specification for the MSC080SMA120B device.

3.1 Package Outline Drawing

This section shows the TO-247 package drawing for the MSC080SMA120B device. The dimensions in the figure below are in millimeters and (inches).

Figure 13 • Package Outline Drawing

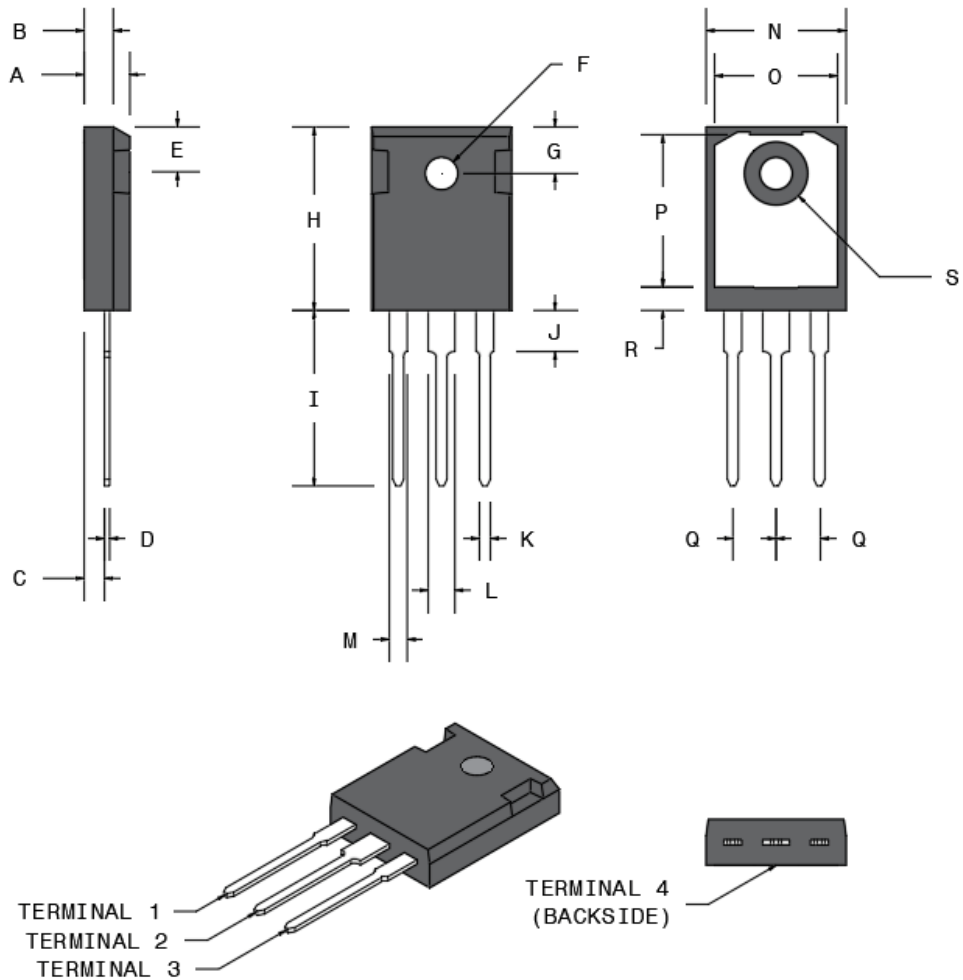

The following table shows the MSC040SMA120B dimensions and should be used in conjunction with the package outline drawing.

Table 6 • TO-247 Dimensions

Symbol	Min (mm)	Max (mm)	Min (in.)	Max (in.)
A	4.69	5.31	0.185	0.209
B	1.49	2.49	0.059	0.098
C	2.21	2.59	0.087	0.102
D	0.40	0.79	0.016	0.031
E	5.38	6.20	0.212	0.244
F	3.50	3.81	0.138	0.150
G	6.15 BSC		0.242 BSC	
H	20.80	21.46	0.819	0.845
I	19.81	20.32	0.780	0.800
J	4.00	4.50	0.157	0.177
K	1.01	1.40	0.040	0.055
L	2.87	3.12	0.113	0.123
M	1.65	2.13	0.065	0.084
N	15.49	16.26	0.610	0.640
O	13.50	14.50	0.531	0.571
P	16.50	17.50	0.650	0.689
Q	5.45 BSC		0.215 BSC	
R	2.00	2.75	0.079	0.108
S	7.10	7.50	0.280	0.295
Terminal 1	Gate			
Terminal 2	Drain			
Terminal 3	Source			
Terminal 4	Drain			

**Microsemi Headquarters**

One Enterprise, Aliso Viejo,
CA 92656 USA
Within the USA: +1 (800) 713-4113
Outside the USA: +1 (949) 380-6100
Sales: +1 (949) 380-6136
Fax: +1 (949) 215-4996
Email: sales.support@microsemi.com
www.microsemi.com

© 2019 Microsemi. All rights reserved. Microsemi and the Microsemi logo are trademarks of Microsemi Corporation. All other trademarks and service marks are the property of their respective owners.

Microsemi makes no warranty, representation, or guarantee regarding the information contained herein or the suitability of its products and services for any particular purpose, nor does Microsemi assume any liability whatsoever arising out of the application or use of any product or circuit. The products sold hereunder and any other products sold by Microsemi have been subject to limited testing and should not be used in conjunction with mission-critical equipment or applications. Any performance specifications are believed to be reliable but are not verified, and Buyer must conduct and complete all performance and other testing of the products, alone and together with, or installed in, any end-products. Buyer shall not rely on any data and performance specifications or parameters provided by Microsemi. It is the Buyer's responsibility to independently determine suitability of any products and to test and verify the same. The information provided by Microsemi hereunder is provided "as is, where is" and with all faults, and the entire risk associated with such information is entirely with the Buyer. Microsemi does not grant, explicitly or implicitly, to any party any patent rights, licenses, or any other IP rights, whether with regard to such information itself or anything described by such information. Information provided in this document is proprietary to Microsemi, and Microsemi reserves the right to make any changes to the information in this document or to any products and services at any time without notice.

Microsemi, a wholly owned subsidiary of Microchip Technology Inc. (Nasdaq: MCHP), offers a comprehensive portfolio of semiconductor and system solutions for aerospace & defense, communications, data center and industrial markets. Products include high-performance and radiation-hardened analog mixed-signal integrated circuits, FPGAs, SoCs and ASICs; power management products; timing and synchronization devices and precise time solutions, setting the world's standard for time; voice processing devices; RF solutions; discrete components; enterprise storage and communication solutions; security technologies and scalable anti-tamper products; Ethernet solutions; Power-over-Ethernet ICs and midspans; as well as custom design capabilities and services. Microsemi is headquartered in Aliso Viejo, California, and has approximately 4,800 employees globally. Learn more at www.microsemi.com.

050-7736 | November 2019 | Released