

REVISIONS					
REV	ECO	DESCRIPTION	DATE	BY	APPR
A1	--	RELEASED DRAWING	Jun-20-2018	Blink	Tommy

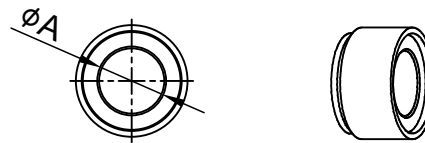
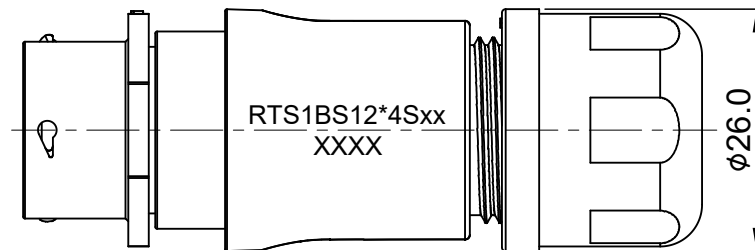
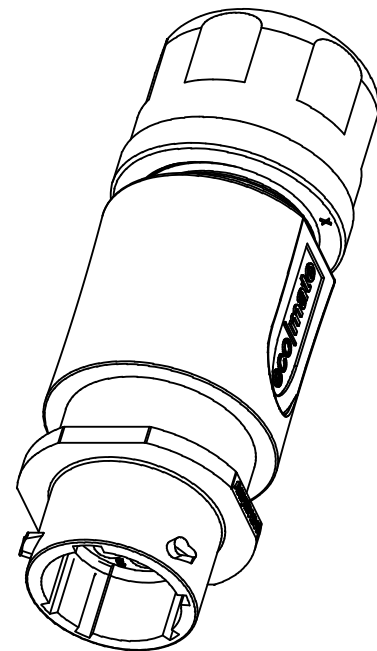
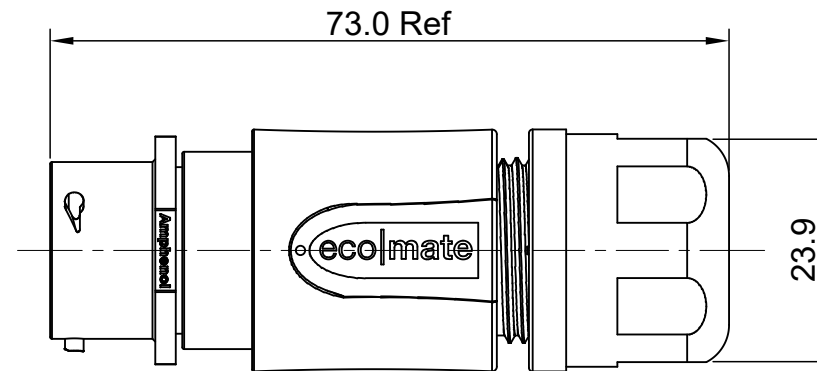
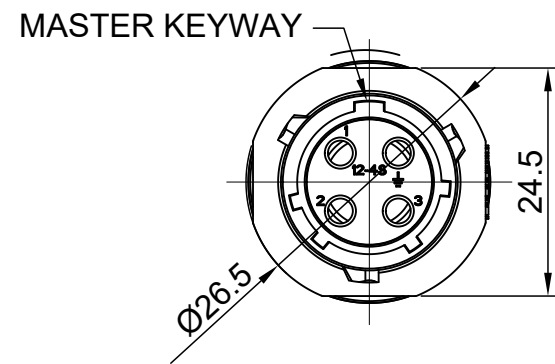

NOTES: (UNLESS OTHERWISE SPECIFIED)

- MATERIAL:
 - SHELL: THERMOPLASTIC, UL94 V-0.
 - INSERT: THERMOPLASTIC, UL94 V-0.
 - O-RING: NBR/SILICONE RUBBER.
 - BACK SHELL: THERMOPLASTIC, UL94 V-0.
 - CLAMP NUT: THERMOPLASTIC, UL94 V-0.
 - CLAMP RING: THERMOPLASTIC, UL94 V-0.
 - CABLE SEAL: EPDM.
- SPECIFICATIONS:
 - RATED CURRENT: 13A (MAX).
 - RATED VOLTAGE: 500V(AC/DC).
 - OPERATING TEMPERATURE: SEE TABLE.
 - DIELECTRIC WITHSTANDING VOLTAGE: LESS THAN 2 MILLIAMPS CURRENT LEAKAGE@2000 VOLTS AC.
 - INSULATION RESISTANCE: 5000 MEGOHMS MIN.
 - IP-CLASS: IP67 AND IP69K IN THE MATED CONDITION.
 - MATING CYCLES DURABILITY: 500 CYCLES MIN.
 - RoHS COMPLIANT.
- SUITABLE CONTACTS : 16# CONTACT.
- ALL DIMENSIONS ARE FOR REFERENCE USE ONLY.
- ADD LOCTITE TO RETAIN BACKSHELL DURING UN-MATING AND TO PROVIDE ADDITIONAL PROTECTION AGAINST VIBRATION.

DIMENSION ϕA	CABLE OD RANGE
9.5MM	6.0-9.0mm
12.2MM	8.5-12.0mm

KEY	PART NUMBER	
	-40°C ~ 105°C	-40°C ~ 125°C
N	RTS1BS12N4S	RTS1BS12N4S03

QUANTITY	PART NUMBER	DESCRIPTION	ITEM
MATERIALS LIST			
UNLESS OTHERWISE SPECIFIED 1) All dimensions are in metric(mm). 2) Tolerances are as follows: 1 PL DEC ±0.30 2 PL DEC ±0.15 3 PL DEC ±0.08 3) Note reference =		SIGNATURES DRAWN: Blink CHECKED: Tod ENGINEER: APPROVAL: Tommy	DATE Jun-20-2018 Jun-20-2018 Jun-20-2018
MATERIAL SPECIFICATIONS:		Amphenol	
PROCESS SPECIFICATIONS:		Sine Systems - www.amphenol-sine.com 44724 Morley Drive Clinton Township, MI 48036	
NEXT ASSY:		CUSTOMER: ECO-MATE, RECPTACLE, BACK SHELL, SIZE 12,4POS, SOCKET	
THIS DRAWING IS SUPPLIED FOR INFORMATION ONLY. DESIGN FEATURES, SPECIFICATIONS AND PERFORMANCE DATA SHOWN HEREON ARE THE PROPERTY OF THE AMPHENOL CORPORATION. NO RIGHTS OF REPRODUCTION ARE IMPLIED. ALL DIMENSIONS ARE SUBJECT TO NORMAL MANUFACTURING VARIATIONS.		SIZE: B TYPE: C- SCALE: NONE	DWG NO: RTS1BS12*4Sxx REVISION: A1
		SHEET 1 OF 1	

TITLE: ECO-MATE, RECPTACLE, BACK SHELL, SIZE 12,4POS, SOCKET
DWG NO: RTS1BS12*4Sxx
REV: A1
SH: 1
OF: 1

ecomate® RM/RSSM/Aquarius™ - Contact Size 16 Options

Crimp Contacts, Machined				
Part Number		AWG	Wire Range (mm ²)	Plating
Male	Female			
MP14M23F	MS14M23F	14	2.0-2.5	Gold Flash
MP14M23G5	MS14M23G5	14	2.0-2.5	Gold 5μ"
MP14M23G10	MS14M23G10	14	2.0-2.5	Gold 10μ"
MP14M23G15	MS14M23G15	14	2.0-2.5	Gold 15μ"
MP14M23G30	MS14M23G30	14	2.0-2.5	Gold 30μ"
MP16M23F	MS16M23F	18-16	0.75-1.5	Gold Flash
MP16M23G5	MS16M23G5	18-16	0.75-1.5	Gold 5μ"
MP16M23G10	MS16M23G10	18-16	0.75-1.5	Gold 10μ"
MP16M23G15	MS16M23G15	18-16	0.75-1.5	Gold 15μ"
MP16M23G30	MS16M23G30	18-16	0.75-1.5	Gold 30μ"
MP20M23F	MS20M23F	22-20	0.34-0.50	Gold Flash
MP20M23G5	MS20M23G5	22-20	0.34-0.50	Gold 5μ"
MP20M23G10	MS20M23G10	22-20	0.34-0.50	Gold 10μ"
MP20M23G15	MS20M23G15	22-20	0.34-0.50	Gold 15μ"
MP20M23G30	MS20M23G30	22-20	0.34-0.50	Gold 30μ"
MP24M23F	MS24M23F	26-24	0.14-0.25	Gold Flash
MP24M23G5	MS24M23G5	26-24	0.14-0.25	Gold 5μ"
MP24M23G10	MS24M23G10	26-24	0.14-0.25	Gold 10μ"
MP24M23G15	MS24M23G15	26-24	0.14-0.25	Gold 15μ"
MP24M23G30	MS24M23G30	26-24	0.14-.025	Gold 30μ"

Tooling, Machined	
Part Number	Description
QXRT16	Contact Extraction Tool, #16 (Ø 1.6) Contact
MFx-3959	Hand Crimp Tool for Machined Contacts
MFx-3960	Pneumatic Crimp Tool for Machined Contact

Plating Options, All	
Symbol	Plating
T	Tin Plated (for Stamped & Formed Contacts)
S	Silver Plated 5Um (for Machined Contacts)
F	Gold Plated
G5	Gold Plated (Thickness 5μ")
G10	Gold Plated (Thickness 10μ")
G15	Gold Plated (Thickness 15μ")
G30	Gold Plated (Thickness 30μ")

Crimp Contacts, Stamped & Formed				
Part Number		AWG	Wire Range (mm ²)	Plating
Male	Female			
SP14M2F	SS14M2F	14	2.0-2.5	Gold Flash
SP14M2G5	SS14M2G5	14	2.0-2.5	Gold 5μ"
SP14M2G10	SS14M2G10	14	2.0-2.5	Gold 10μ"
SP14M2G15	SS14M2G15	14	2.0-2.5	Gold 15μ"
SP14M2G30	SS14M2G30	14	2.0-2.5	Gold 30μ"
SP16M2F	SS16M2F	18-16	0.75-1.5	Gold Flash
SP16M2G5	SS16M2G5	18-16	0.75-1.5	Gold 5μ"
SP16M2G10	SS16M2G10	18-16	0.75-1.5	Gold 10μ"
SP16M2G15	SS16M2G15	18-16	0.75-1.5	Gold 15μ"
SP16M2G30	SS16M2G30	18-16	0.75-1.5	Gold 30μ"
SP20M2F	SS20M2F	22-20	0.34-0.50	Gold Flash
SP20M2G5	SS20M2G5	22-20	0.34-0.50	Gold 5μ"
SP20M2G10	SS20M2G10	22-20	0.34-0.50	Gold 10μ"
SP20M2G15	SS20M2G15	22-20	0.34-0.50	Gold 15μ"
SP20M2G30	SS20M2G30	22-20	0.34-0.50	Gold 30μ"
SP24M2F	SS24M2F	26-24	0.14-0.25	Gold Flash
SP24M2G5	SS24M2G5	26-24	0.14-0.25	Gold 5μ"
SP24M2G10	SS24M2G10	26-24	0.14-0.25	Gold 10μ"
SP24M2G15	SS24M2G15	26-24	0.14-0.25	Gold 15μ"
SP24M2G30	SS24M2G30	26-24	0.14-0.25	Gold 30μ"

Tooling, Stamped & Formed	
Part Number	Description
QXRT16	Contact Extraction Tool, #16 (Ø 1.6) Contact
MFx-3954	Hand Tool, Stamped & Formed Contact, Size 16, 20-14AWG
MFx-3957	Crimp Die, Stamped & Formed Contact

Misc Tooling, All	
Part Number	Description
CA-4020-59	Sealing Plug, Size 16 & 20

Standard Quantity Order Options	
Machined	Stamped & Formed
Bulk Package, 500 Pieces	Reel, 3000 Pieces