

1-583717-1 ✓ ACTIVE

AMP | AMP Twin-Leaf

TE Internal #: 1-583717-1

Housing, Receptacle, Wire-to-Board, 25 Position, .1 in [2.54 mm]
Centerline, Crimp, 2 Row, Black, Printed Circuit Board, Power &
Signal, AMP Twin-Leaf

[View on TE.com >](#)



Connectors > PCB Connectors > Wire-to-Board Connectors > Wire-to-Board Connector Assemblies & Housings

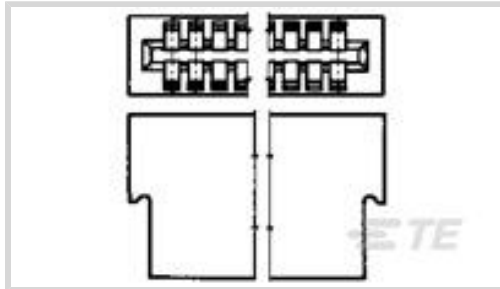

Connector Product Type: **Housing**

Connector & Housing Type: **Receptacle**

Connector System: **Wire-to-Board**

Number of Positions: **25**

Centerline (Pitch): **2.54 mm [.1 in]**

Features

Product Type Features

Connector Product Type	Housing
Connector & Housing Type	Receptacle
Connector System	Wire-to-Board
Connector & Contact Terminates To	Printed Circuit Board

Configuration Features

Number of Dual Positions	25
Number of Positions	25
Number of Rows	2

Body Features

Primary Product Color	Black
-----------------------	-------

Contact Features

Contact Current Rating (Max)	5 A
------------------------------	-----

Termination Features

Termination Method to Wire & Cable	Crimp
------------------------------------	-------

Mechanical Attachment

Strain Relief	Without
PCB Mount Retention	Without
Mating Retention	Without



Connector Mounting Type	Board Mount
-------------------------	-------------

Housing Features

Housing Material	Polyester GF
Centerline (Pitch)	2.54 mm[.1 in]

Dimensions

	.75 in
--	--------

Usage Conditions

Operating Temperature Range	-55 – 105 °C[-67 – 221 °F]
-----------------------------	----------------------------

Operation/Application

Circuit Application	Power & Signal
---------------------	----------------

Industry Standards

Glow Wire Rating	Standard Part - Not Glow Wire
UL Flammability Rating	UL 94V-0

Packaging Features

Packaging Quantity	200
Packaging Method	Carton

Product Compliance

[For compliance documentation, visit the product page on TE.com>](#)

EU RoHS Directive 2011/65/EU	Compliant
EU ELV Directive 2000/53/EC	Compliant
China RoHS 2 Directive MIIT Order No 32, 2016	No Restricted Materials Above Threshold
EU REACH Regulation (EC) No. 1907/2006	Current ECHA Candidate List: JUNE 2023 (235) Candidate List Declared Against: JAN 2023 (233) Does not contain REACH SVHC
Halogen Content	Not Low Halogen - contains Br or Cl > 900 ppm.
Solder Process Capability	Not applicable for solder process capability













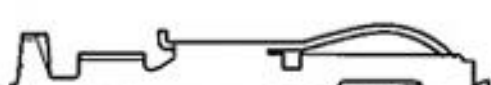

Product Compliance Disclaimer

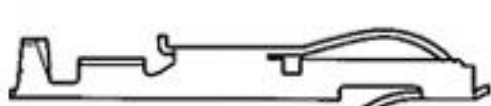
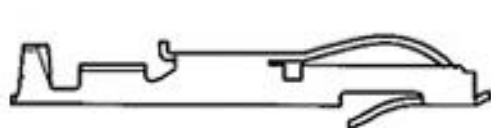
This information is provided based on reasonable inquiry of our suppliers and represents our current actual knowledge based on the information they provided. This information is subject to change. The part numbers that TE has identified as EU RoHS compliant have a maximum concentration of 0.1% by weight in homogenous materials for lead, hexavalent chromium, mercury, PBB, PBDE, DBP, BBP, DEHP, DIBP, and 0.01% for cadmium, or qualify for an exemption to these

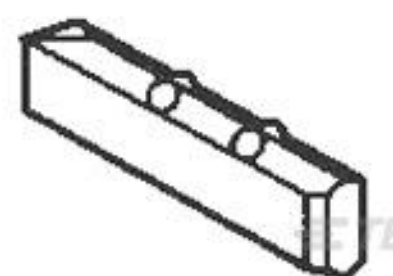

limits as defined in the Annexes of Directive 2011/65/EU (RoHS2). Finished electrical and electronic equipment products will be CE marked as required by Directive 2011/65/EU. Components may not be CE marked. Additionally, the part numbers that TE has identified as EU ELV compliant have a maximum concentration of 0.1% by weight in homogenous materials for lead, hexavalent chromium, and mercury, and 0.01% for cadmium, or qualify for an exemption to these limits as defined in the Annexes of Directive 2000/53/EC (ELV). Regarding the REACH Regulation, the information TE provides on SVHC in articles for this part number is based on the latest European Chemicals Agency (ECHA) 'Guidance on requirements for substances in articles' posted at this URL: <https://echa.europa.eu/guidance-documents/guidance-on-reach>

Compatible Parts

 <p>TE Part # 5-583649-3 CONT.CRP.SNAP TW.LF.STRIP</p>	 <p>TE Part # 583854-3 TWIN LF SOLD EYE CONTACT</p>	 <p>TE Part # 583879-1 CONTACT CSTL 15AU 50SN/PB</p>	 <p>TE Part # 583649-3 CONT.CRP.SNAP TW.LF.STRIP</p>
 <p>TE Part # 1-583649-1 TWIN LEAF STRIP TERM</p>	 <p>TE Part # 1-583884-5 CONTACT CSTL 15AU 50SN/PB</p>	 <p>TE Part # 1-881099-3 TWIN LEAF CONTACT</p>	 <p>TE Part # 5-583649-2 CONT.CRP.SNAP TW.LF.STRIP</p>
 <p>TE Part # 5-583854-3 TWIN LF SOLD EYE CONTACT</p>	 <p>TE Part # 5-583857-1 CONT TW-LF CRP SANP</p>	 <p>TE Part # 5-583879-4 CONTACT CSTL 15AU 50SN/PB</p>	 <p>TE Part # 5-583879-8 CONTACT CSTL 15AU 50SN/PB</p>
 <p>TE Part # 5-583879-9 CONTACT CSTL 15AU 50SN/PB</p>	 <p>TE Part # 531477-4 CONT.MINI-LEAF STRIP</p>	 <p>TE Part # 583274-3 KEYING PLUG</p>	 <p>TE Part # 583649-2 CONT.CRP.SNAP TW.LF.STRIP</p>

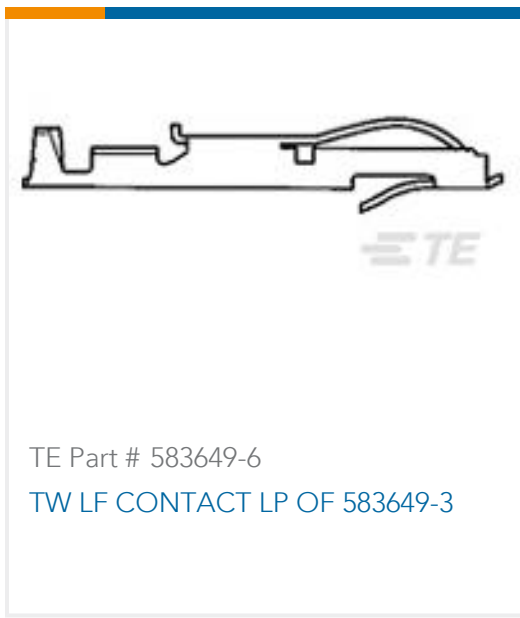

TE Part # 583649-6
TW LF CONTACT LP OF 583649-3



TE Part # 583879-4
CONTACT CSTL 15AU 50SN/PB



TE Part # 583879-8
CONTACT CSTL 15AU 50SN/PB



TE Part # 583879-9
CONTACT CSTL 15AU 50SN/PB

Also in the Series | AMP Twin-Leaf

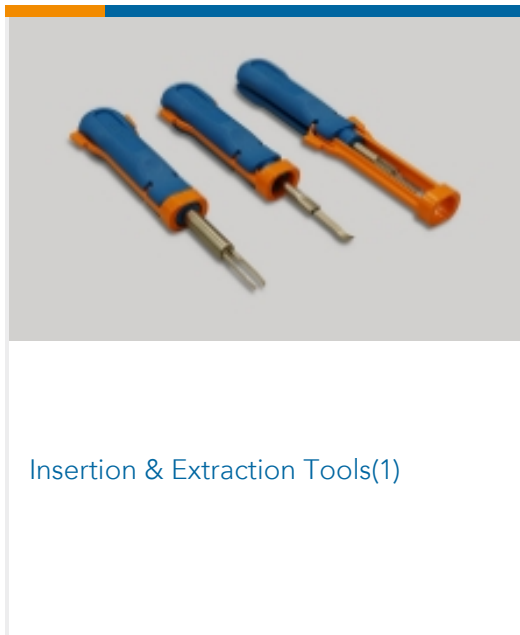

Insertion & Extraction Tools(1)

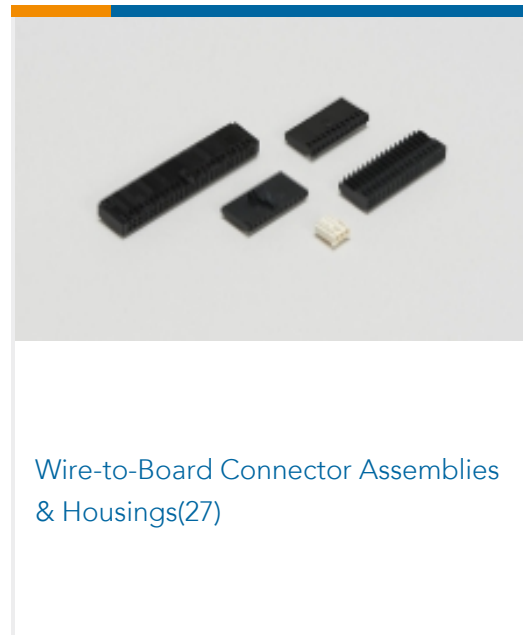

Wire-to-Board Connector Assemblies & Housings(27)

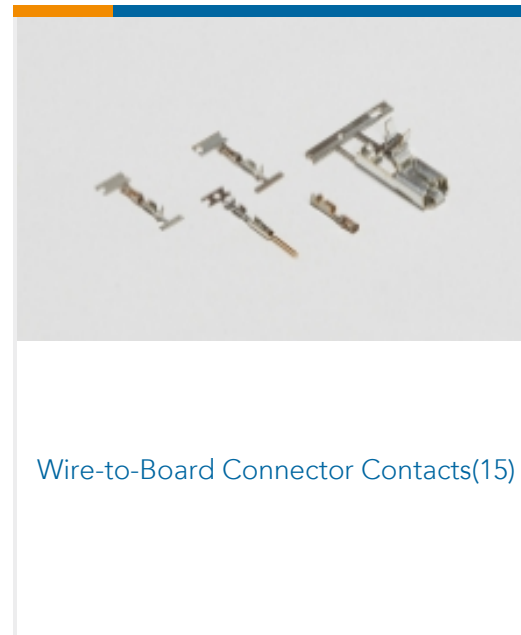

Wire-to-Board Connector Contacts(15)

Customers Also Bought



TE Part #205204-4
CRIMP SNAP PLUG ASSY,SIZE 1



TE Part #1-2834075-3
3P REC, MINIATURE WATERPROOF CONN.WHITE



TE Part #102387-2
14 MODIV HSG COMP DR .100 POL



TE Part #172333-1
MINI UNIVERSAL M-N-L HOUSING

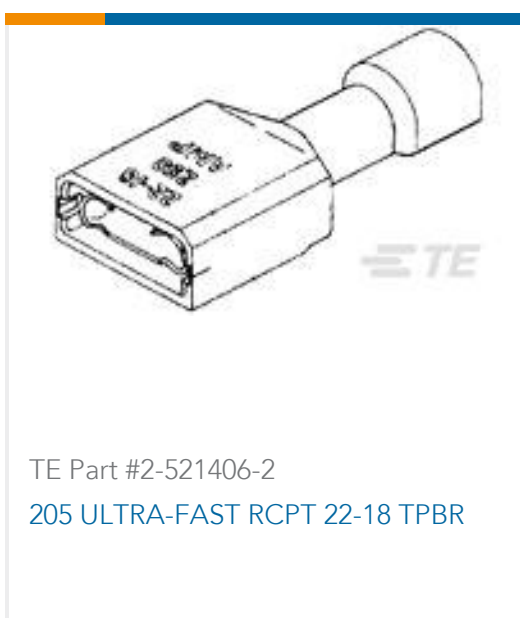

TE Part #2-521406-2
205 ULTRA-FAST RCPT 22-18 TPBR

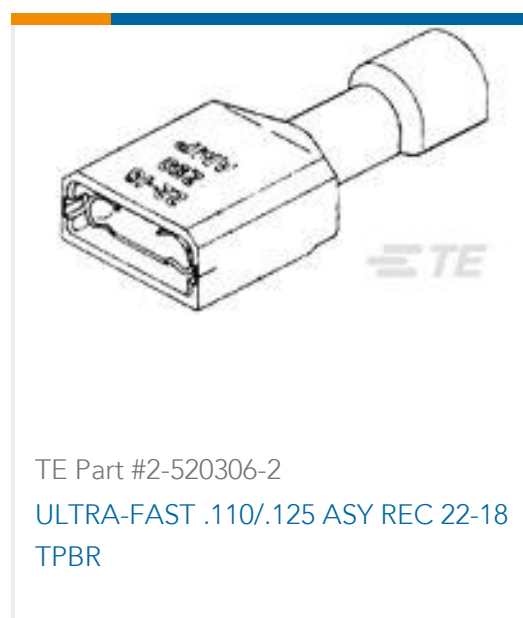

TE Part #2-520306-2
ULTRA-FAST .110/.125 ASY REC 22-18 TPBR



TE Part #5-583853-3
TWIN LEAF TERM. STRIP CSTL



TE Part #1-770902-0
MINI UMNL SOK 26-22 AWG AU



TE Part #178125-4
U/POWER PLUG HSG 2P 7.29MM

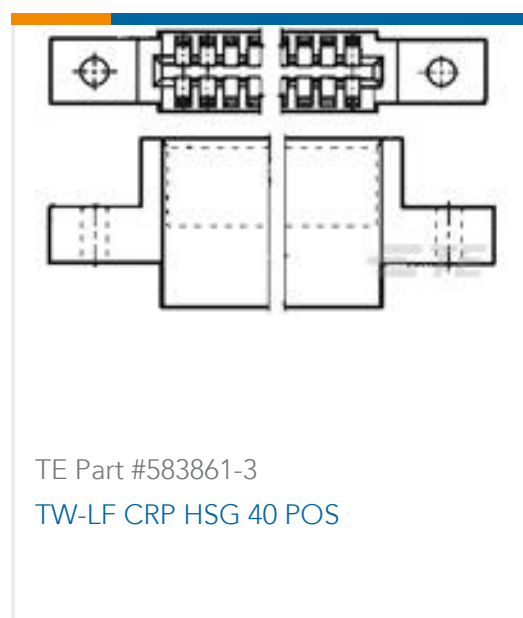

TE Part #583861-3
TW-LF CRP HSG 40 POS



Documents

Product Drawings

[TW-LEAF CRP HSG 25 POS 100 C/L](#)

English

CAD Files

Customer View Model

[ENG_CVM_CVM_1-583717-1_AU.2d_dxf.zip](#)

English

[3D PDF](#)

3D

Customer View Model

[ENG_CVM_CVM_1-583717-1_AU.3d_igs.zip](#)

English

Customer View Model

[ENG_CVM_CVM_1-583717-1_AU.3d_stp.zip](#)

English

By downloading the CAD file I accept and agree to the [Terms and Conditions](#) of use.

Product Specifications

[Product Specification](#)

English

[Product Specification](#)

English

Instruction Sheets

[Instruction Sheet \(U.S.\)](#)

English

Agency Approvals

[UL](#)

English