

THESE DRAWINGS ARE THE PROPERTY OF QUALTEK ELECTRONICS AND NOT TO BE REPRODUCED FOR OR COMMUNICATED TO A THIRD PARTY WITHOUT THE EXPRESS WRITTEN PERMISSION OF AN OFFICER OF QUALTEK ELECTRONICS.

REVISION			
REV.	DESCRIPTION	DATE	APPROVED

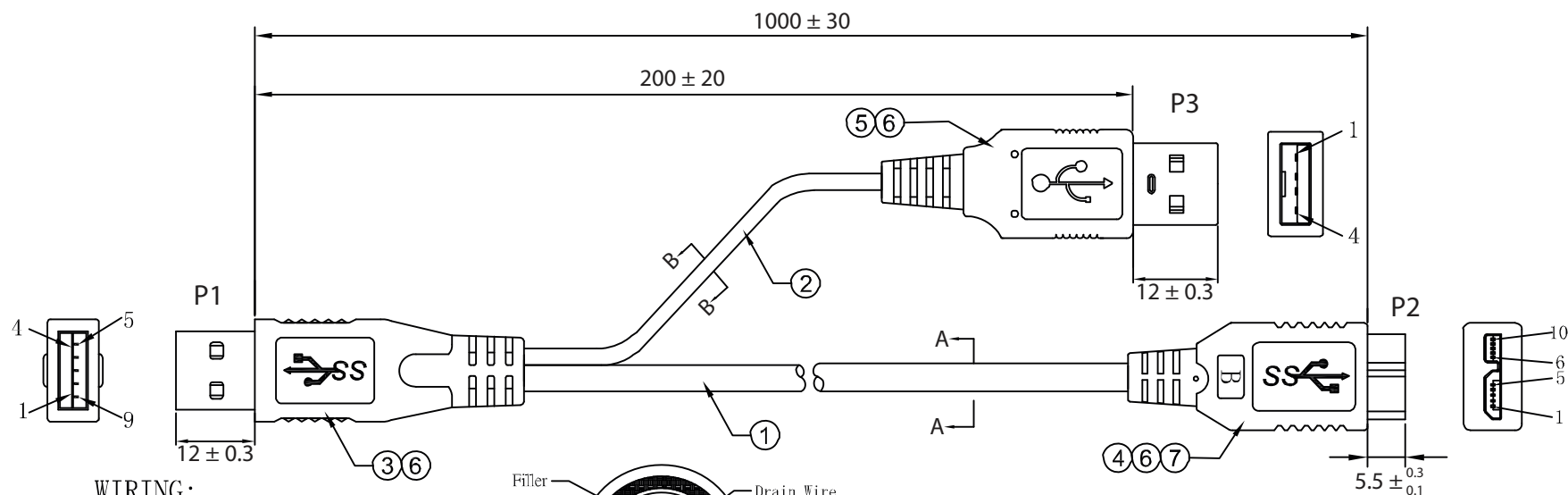

WIRING:

P3	P1	COLOR	P2
1 — RED	1 — RED	1 — RED	1
4 — BLACK	2 — WHITE	2 — WHITE	2
	3 — GREEN	3 — GREEN	3
	4 — BLACK	4 — BLACK	5
	5 — BLUE	5 — BLUE	6
	6 — YELLOW	6 — YELLOW	7
	7 — DRAIN WIRE	7 — DRAIN WIRE	8
	8 — PURPLE	8 — PURPLE	9
	9 — ORANGE	9 — ORANGE	10
SHIELD — BRAID — SHIELD	BRAID	SHIELD	SHIELD

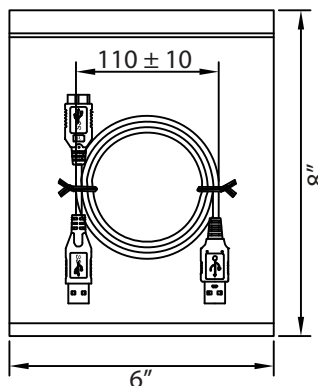
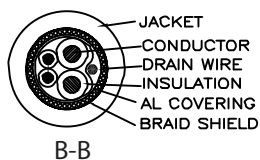
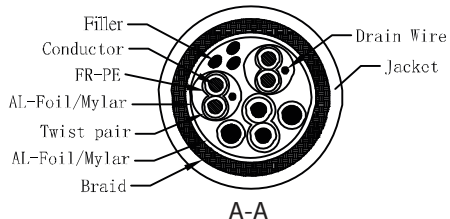

CONTROLLED

No.	PARTS NAME	SPECIFICATION STANDARD	QTY	REMARKS
①	CABLE	UL 20276 O.D. 5.5mm COLOR: BLACK	1	
②	CABLE	UL 2725 O.D. 3.5mm COLOR: BLACK	1	
③	USB 3.0 A M 9PIN GOLD PLATED	30U" SHELL NICKEL PLATED INSULATOR BLUE	1	
④	MICRO USB3.0 B M 10PIN GOLD PLATED	15U" SHELL NICKEL PLATED INSULATOR BLACK	1	
⑤	USB A/M 4PIN GOLD PLATED FLASH	SHELL NICKEL PLATED INSULATOR BLACK	1	
⑥	PVC	45P PVC BLACK	20	g
⑦	PE	CLEAR PE	3	g
⑧	CABLE TIE	L=9cm COLOR: BLACK	2	

NOTES:

- CABLE 1: UL20276
(1Px30AWG+D+AL+MY)x2C+1Px30AWG+2Cx24AWG+AL+B
OUTER JACKET: BLACK, O.D.: 5.5mm
- CABLE 2: UL2725
(1Px30AWG+28AWGx2C)+A+B(32B AM)+D
OUTER JACKET: BLACK, O.D.: 3.5mm
- CONNECTORS: USB 3.0 A MALE TO MICRO USB 3.0 B MALE + POWER
- HOOD: MOLDED TYPE, COLOR: BLACK
- PACKING: 1PC/POLYBAG
- RoHS COMPLIANT

Qualtek Electronics Corp.
WCI DIVISION

Part Number: **3023011-01M**



Description:
USB 3.0 A/M - MICRO USB 3.0 B/M + POWER CABLE

Dim range (mm)	Tolerance +/- (mm)	UNIT: mm		
0-1	0.15	Drawn / Date	Checked / Date	Approved / Date
1-6	0.20			
6-18	0.30			
18-50	0.50			
50-120	0.70			
120-250	0.90			
250-500	1.20	R.Nuti 06-25-10	06-25-10	LY / 06-25-10