

# MMBT4403L, SMMBT4403L

## Switching Transistor

### PNP Silicon

#### Features

- S Prefix for Automotive and Other Applications Requiring Unique Site and Control Change Requirements; AEC-Q101 Qualified and PPAP Capable
- These Devices are Pb-Free, Halogen Free/BFR Free and are RoHS Compliant

#### MAXIMUM RATINGS

Rating	Symbol	Value	Unit
Collector-Emitter Voltage	$V_{CEO}$	-40	Vdc
Collector-Base Voltage	$V_{CBO}$	-40	Vdc
Emitter-Base Voltage	$V_{EBO}$	-5.0	Vdc
Collector Current - Continuous	$I_C$	-600	mAdc
Collector Current - Peak	$I_{CM}$	-900	mAdc

#### THERMAL CHARACTERISTICS

Characteristic	Symbol	Max	Unit
Total Device Dissipation FR-5 Board (Note 1) @ $T_A = 25^\circ\text{C}$ Derate above $25^\circ\text{C}$	$P_D$	225 1.8	mW mW/ $^\circ\text{C}$
Thermal Resistance, Junction-to-Ambient	$R_{\theta JA}$	556	$^\circ\text{C}/\text{W}$
Total Device Dissipation Alumina Substrate, (Note 2) @ $T_A = 25^\circ\text{C}$ Derate above $25^\circ\text{C}$	$P_D$	300 2.4	mW mW/ $^\circ\text{C}$
Thermal Resistance, Junction-to-Ambient	$R_{\theta JA}$	417	$^\circ\text{C}/\text{W}$
Junction and Storage Temperature	$T_J, T_{stg}$	-55 to +150	$^\circ\text{C}$

Stresses exceeding those listed in the Maximum Ratings table may damage the device. If any of these limits are exceeded, device functionality should not be assumed, damage may occur and reliability may be affected.

\*Transient pulses must not cause the junction temperature to be exceeded.

1. FR-5 =  $1.0 \times 0.75 \times 0.062$  in.
2. Alumina =  $0.4 \times 0.3 \times 0.024$  in. 99.5% alumina.



**ON Semiconductor®**

[www.onsemi.com](http://www.onsemi.com)

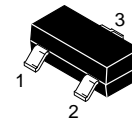
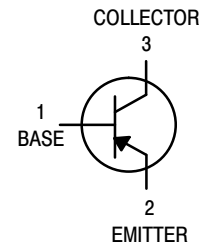

**SOT-23 (TO-236)  
CASE 318  
STYLE 6**

#### MARKING DIAGRAM

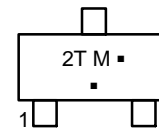

2T = Specific Device Code\*  
M = Date Code\*  
■ = Pb-Free Package

(Note: Microdot may be in either location)

\*Specific Device Code, Date Code or overbar orientation and/or location may vary depending upon manufacturing location. This is a representation only and actual devices may not match this drawing exactly.

#### ORDERING INFORMATION

Device	Package	Shipping†
MMBT4403LT1G	SOT-23 (Pb-Free)	3000 / Tape & Reel
SMMBT4403LT1G	SOT-23 (Pb-Free)	3000 / Tape & Reel
MMBT4403LT3G	SOT-23 (Pb-Free)	10,000 / Tape & Reel

†For information on tape and reel specifications, including part orientation and tape sizes, please refer to our Tape and Reel Packaging Specifications Brochure, BRD8011/D.

# MMBT4403L, SMMBT4403L

## ELECTRICAL CHARACTERISTICS (T<sub>A</sub> = 25°C unless otherwise noted)

Characteristic	Symbol	Min	Max	Unit	
<b>OFF CHARACTERISTICS</b>					
Collector–Emitter Breakdown Voltage (Note 3)	(I <sub>C</sub> = –1.0 mA <sub>dc</sub> , I <sub>B</sub> = 0)	V <sub>(BR)CEO</sub>	–40	–	V <sub>dc</sub>
Collector–Base Breakdown Voltage	(I <sub>C</sub> = –0.1 mA <sub>dc</sub> , I <sub>E</sub> = 0)	V <sub>(BR)CBO</sub>	–40	–	V <sub>dc</sub>
Emitter–Base Breakdown Voltage	(I <sub>E</sub> = –0.1 mA <sub>dc</sub> , I <sub>C</sub> = 0)	V <sub>(BR)EBO</sub>	–5.0	–	V <sub>dc</sub>
Base Cutoff Current	(V <sub>CE</sub> = –35 V <sub>dc</sub> , V <sub>EB</sub> = –0.4 V <sub>dc</sub> )	I <sub>BEV</sub>	–	–0.1	μA <sub>dc</sub>
Collector Cutoff Current	(V <sub>CE</sub> = –35 V <sub>dc</sub> , V <sub>EB</sub> = –0.4 V <sub>dc</sub> )	I <sub>CEX</sub>	–	–0.1	μA <sub>dc</sub>

## ON CHARACTERISTICS

DC Current Gain	(I <sub>C</sub> = –0.1 mA <sub>dc</sub> , V <sub>CE</sub> = –1.0 V <sub>dc</sub> ) (I <sub>C</sub> = –1.0 mA <sub>dc</sub> , V <sub>CE</sub> = –1.0 V <sub>dc</sub> ) (I <sub>C</sub> = –10 mA <sub>dc</sub> , V <sub>CE</sub> = –1.0 V <sub>dc</sub> ) (I <sub>C</sub> = –150 mA <sub>dc</sub> , V <sub>CE</sub> = –2.0 V <sub>dc</sub> ) (I <sub>C</sub> = –500 mA <sub>dc</sub> , V <sub>CE</sub> = –2.0 V <sub>dc</sub> )	h <sub>FE</sub>	30 60 100 100 20	– – – 300 –	–
Collector–Emitter Saturation Voltage (Note 3)	(I <sub>C</sub> = –150 mA <sub>dc</sub> , I <sub>B</sub> = –15 mA <sub>dc</sub> ) (I <sub>C</sub> = –500 mA <sub>dc</sub> , I <sub>B</sub> = –50 mA <sub>dc</sub> )	V <sub>CE(sat)</sub>	– –	–0.4 –0.75	V <sub>dc</sub>
Base–Emitter Saturation Voltage (Note 3)	(I <sub>C</sub> = –150 mA <sub>dc</sub> , I <sub>B</sub> = –15 mA <sub>dc</sub> ) (I <sub>C</sub> = –500 mA <sub>dc</sub> , I <sub>B</sub> = –50 mA <sub>dc</sub> )	V <sub>BE(sat)</sub>	–0.75 –	–0.95 –1.3	V <sub>dc</sub>

## SMALL–SIGNAL CHARACTERISTICS

Current–Gain – Bandwidth Product	(I <sub>C</sub> = –20 mA <sub>dc</sub> , V <sub>CE</sub> = –10 V <sub>dc</sub> , f = 100 MHz)	f <sub>T</sub>	200	–	MHz
Collector–Base Capacitance	(V <sub>CB</sub> = –10 V <sub>dc</sub> , I <sub>E</sub> = 0, f = 1.0 MHz)	C <sub>cb</sub>	–	8.5	pF
Emitter–Base Capacitance	(V <sub>BE</sub> = –0.5 V <sub>dc</sub> , I <sub>C</sub> = 0, f = 1.0 MHz)	C <sub>eb</sub>	–	30	pF
Input Impedance	(I <sub>C</sub> = –1.0 mA <sub>dc</sub> , V <sub>CE</sub> = –10 V <sub>dc</sub> , f = 1.0 kHz)	h <sub>ie</sub>	1.5	15	kΩ
Voltage Feedback Ratio	(I <sub>C</sub> = –1.0 mA <sub>dc</sub> , V <sub>CE</sub> = –10 V <sub>dc</sub> , f = 1.0 kHz)	h <sub>re</sub>	0.1	8.0	X 10 <sup>–4</sup>
Small–Signal Current Gain	(I <sub>C</sub> = –1.0 mA <sub>dc</sub> , V <sub>CE</sub> = –10 V <sub>dc</sub> , f = 1.0 kHz)	h <sub>fe</sub>	60	500	–
Output Admittance	(I <sub>C</sub> = –1.0 mA <sub>dc</sub> , V <sub>CE</sub> = –10 V <sub>dc</sub> , f = 1.0 kHz)	h <sub>oe</sub>	1.0	100	μMhos

## SWITCHING CHARACTERISTICS

Delay Time	(V <sub>CC</sub> = –30 V <sub>dc</sub> , V <sub>EB</sub> = –2.0 V <sub>dc</sub> , I <sub>C</sub> = –150 mA <sub>dc</sub> , I <sub>B1</sub> = –15 mA <sub>dc</sub> )	t <sub>d</sub>	–	15	ns
Rise Time		t <sub>r</sub>	–	20	
Storage Time	(V <sub>CC</sub> = –30 V <sub>dc</sub> , I <sub>C</sub> = –150 mA <sub>dc</sub> , I <sub>B1</sub> = I <sub>B2</sub> = –15 mA <sub>dc</sub> )	t <sub>s</sub>	–	225	ns
Fall Time		t <sub>f</sub>	–	30	

Product parametric performance is indicated in the Electrical Characteristics for the listed test conditions, unless otherwise noted. Product performance may not be indicated by the Electrical Characteristics if operated under different conditions.

3. Pulse Test: Pulse Width ≤ 300 μs, Duty Cycle ≤ 2.0%.

## SWITCHING TIME EQUIVALENT TEST CIRCUIT

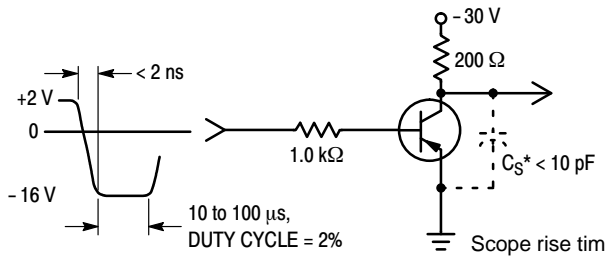

Figure 1. Turn–On Time

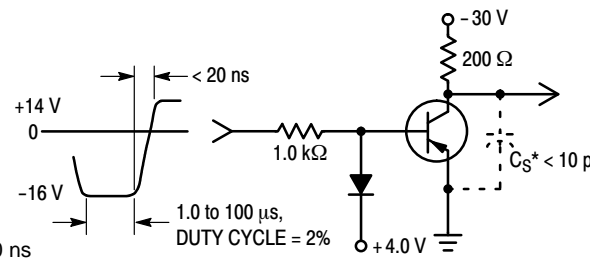

Figure 2. Turn–Off Time

# MMBT4403L, SMMBT4403L

## TRANSIENT CHARACTERISTICS

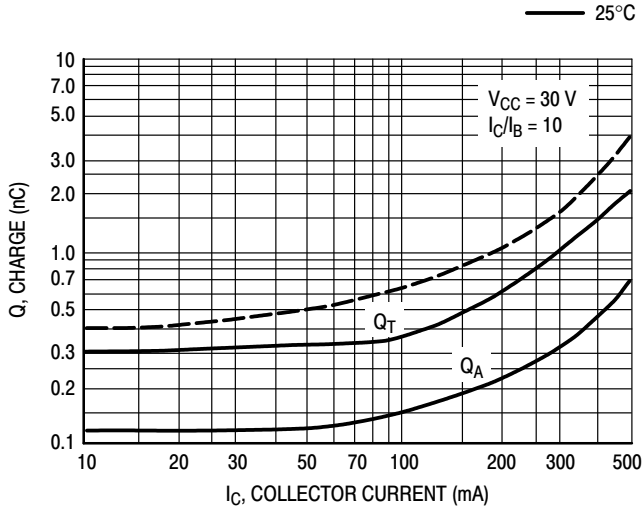

Figure 3. Charge Data

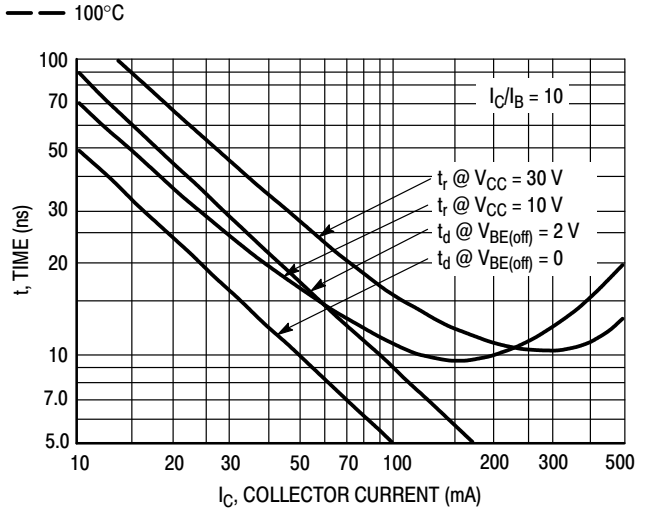

Figure 4. Turn-On Time

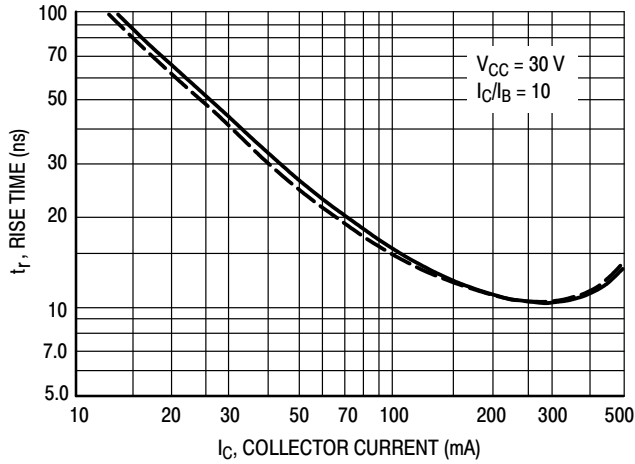

Figure 5. Rise Time

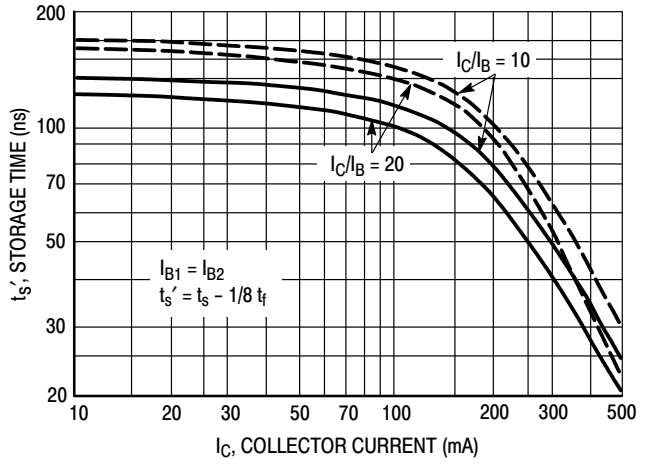

Figure 6. Storage Time

## SMALL-SIGNAL CHARACTERISTICS NOISE FIGURE

V<sub>CE</sub> = -10 Vdc, T<sub>A</sub> = 25°C; Bandwidth = 1.0 Hz

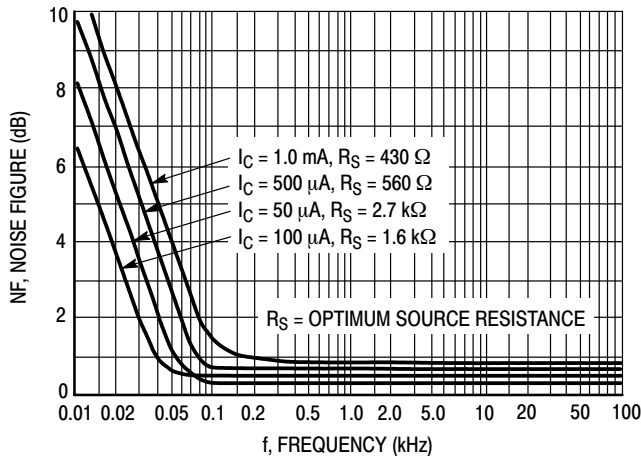

Figure 7. Frequency Effects

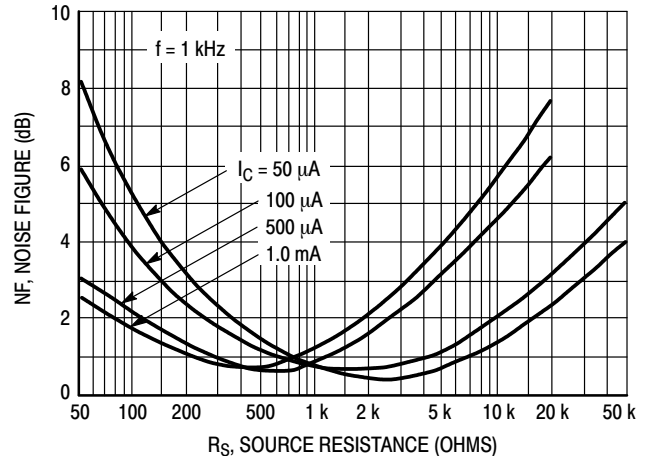

Figure 8. Source Resistance Effects

# MMBT4403L, SMMBT4403L

## h PARAMETERS

$$V_{CE} = 10 \text{ Vdc}, f = 1.0 \text{ kHz}, T_A = 25^\circ\text{C}$$

This group of graphs illustrates the relationship between  $h_{fe}$  and other "h" parameters for this series of transistors. To obtain these curves, a high-gain and a low-gain unit were selected from the MMBT4403LT1 lines, and the same units were used to develop the correspondingly numbered curves on each graph.

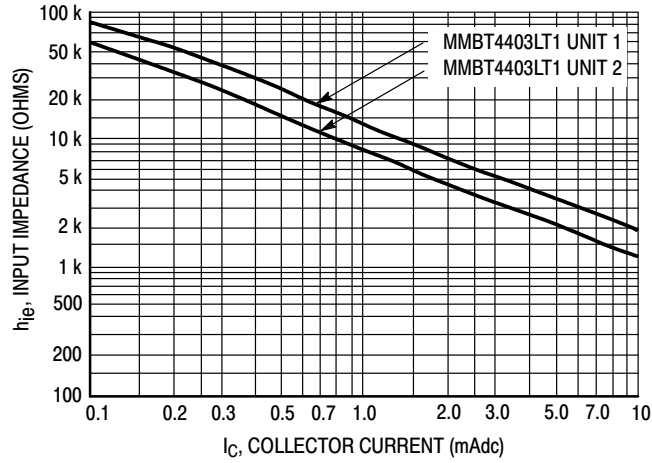

Figure 9. Input Impedance

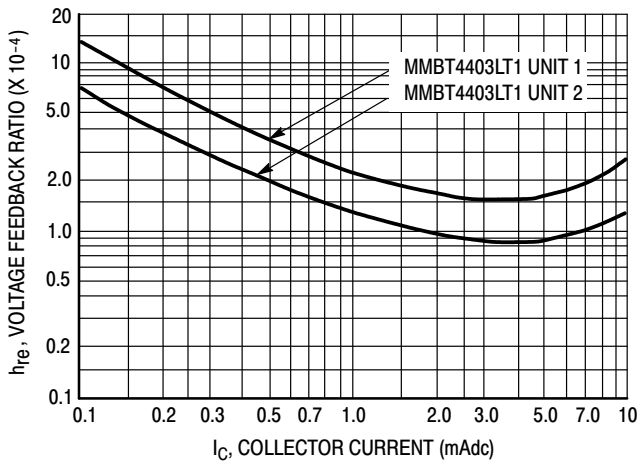

Figure 10. Voltage Feedback Ratio

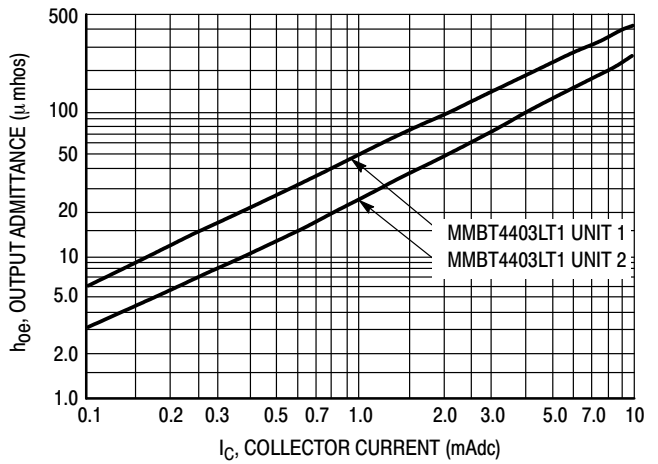

Figure 11. Output Admittance

# MMBT4403L, SMMBT4403L

## STATIC CHARACTERISTICS

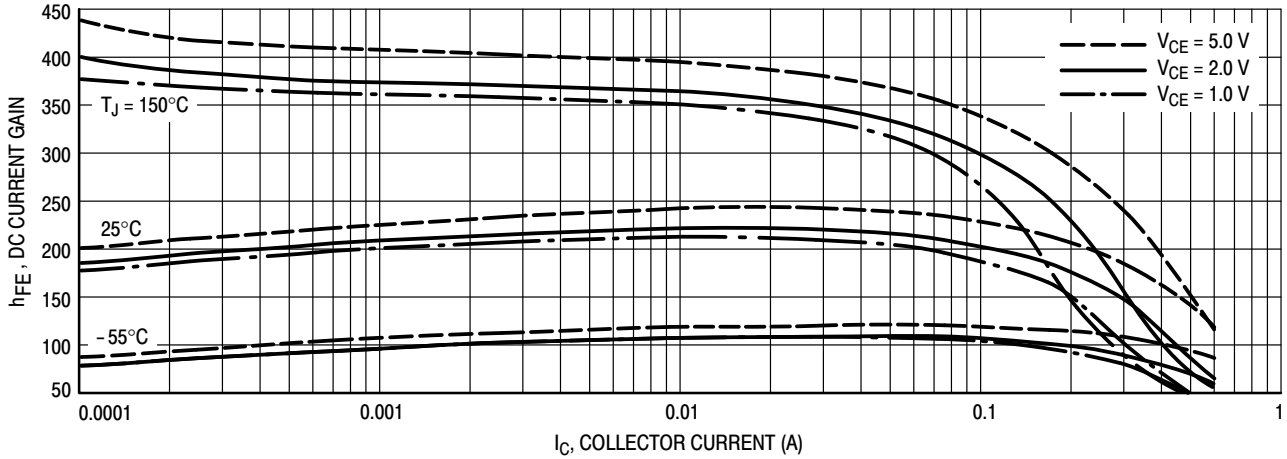

Figure 12. DC Current Gain

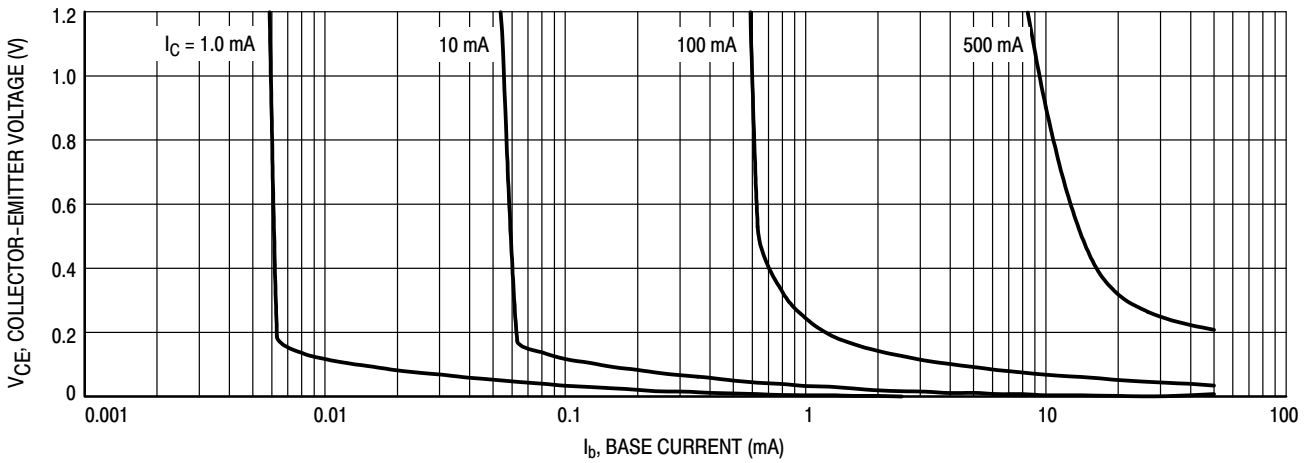

Figure 13. Collector Saturation Region

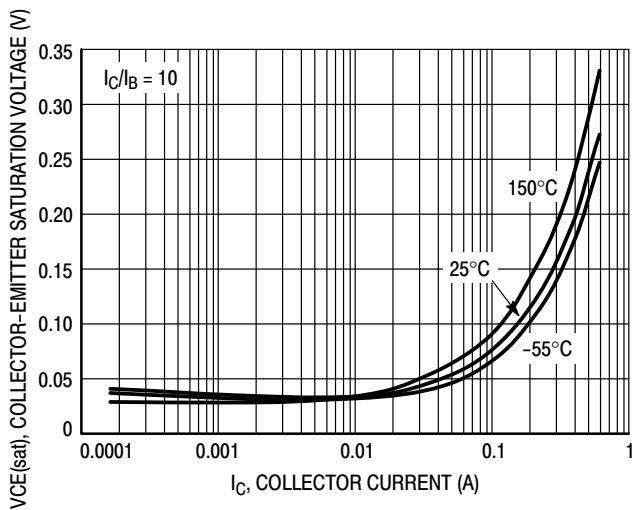

Figure 14. Collector-Emitter Saturation Voltage vs. Collector Current

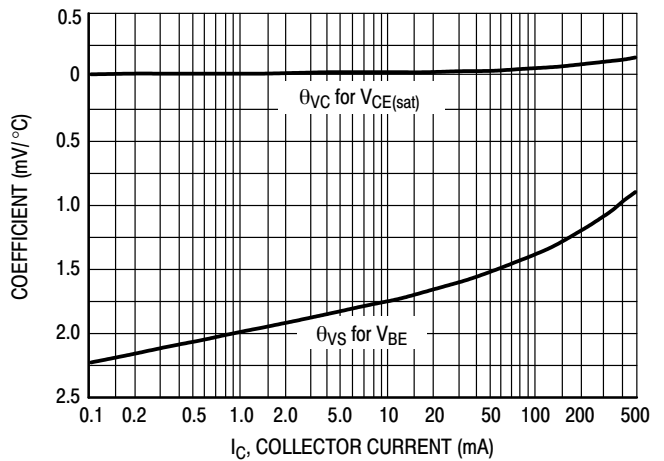
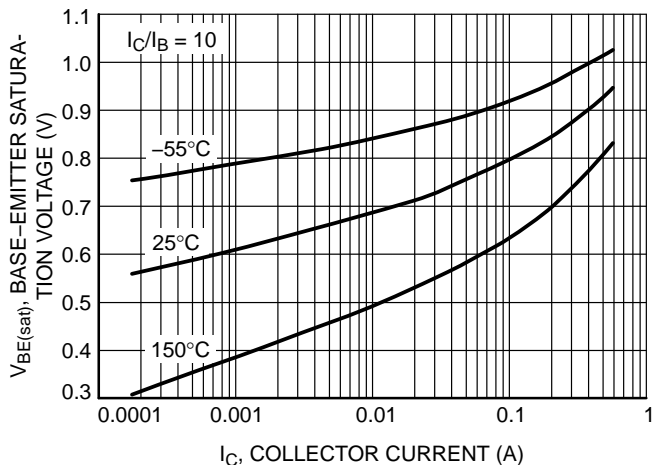

Figure 15. Temperature Coefficients

# MMBT4403L, SMMBT4403L

## STATIC CHARACTERISTICS



**Figure 16. Base-Emitter Saturation Voltage vs. Collector Current**

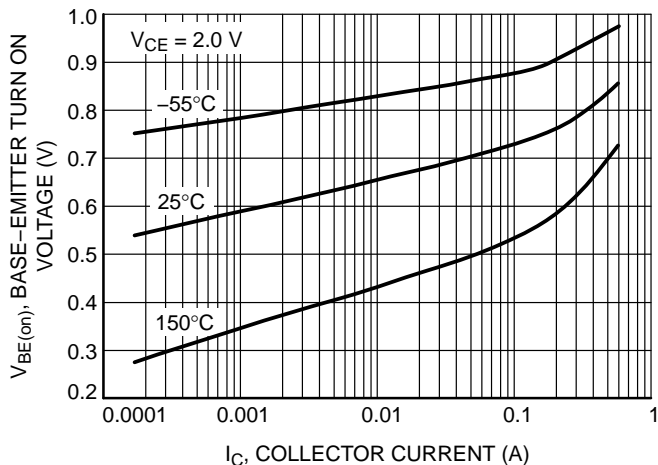

**Figure 17. Base-Emitter Turn On Voltage vs. Collector Current**

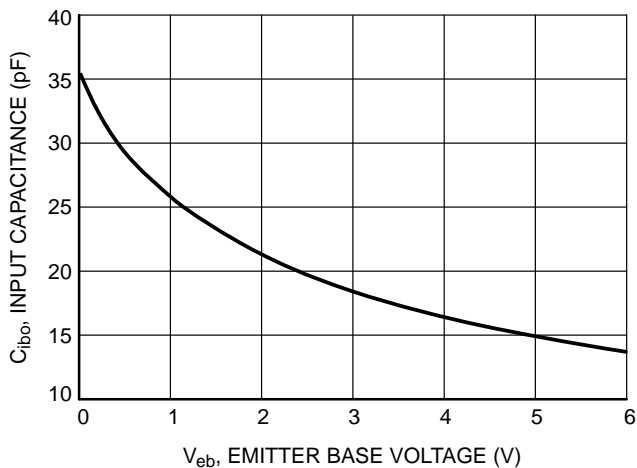

**Figure 18. Input Capacitance vs. Emitter Base Voltage**

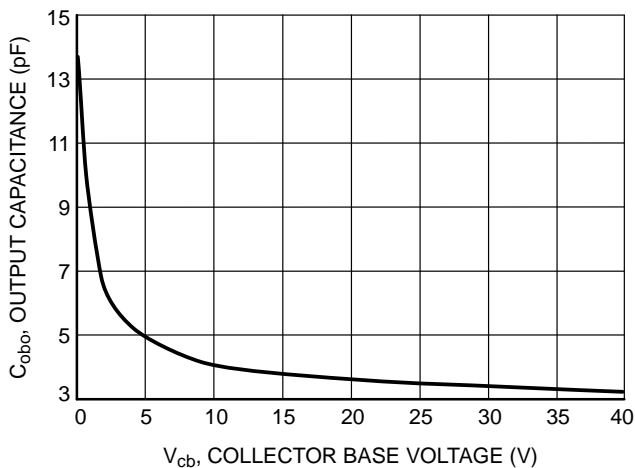

**Figure 19. Output Capacitance vs. Collector Base Voltage**

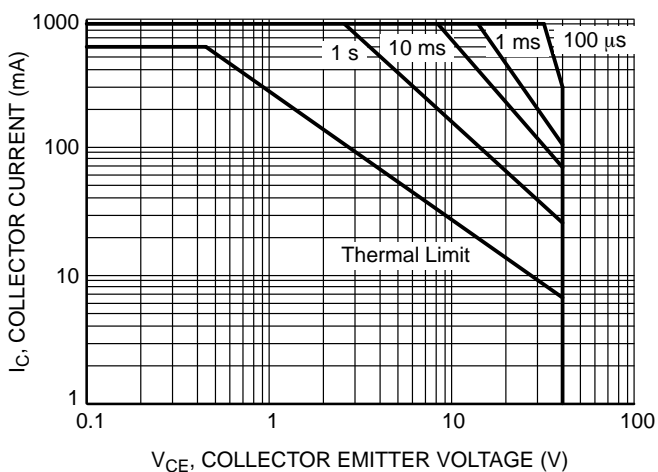

**Figure 20. Safe Operating Area**

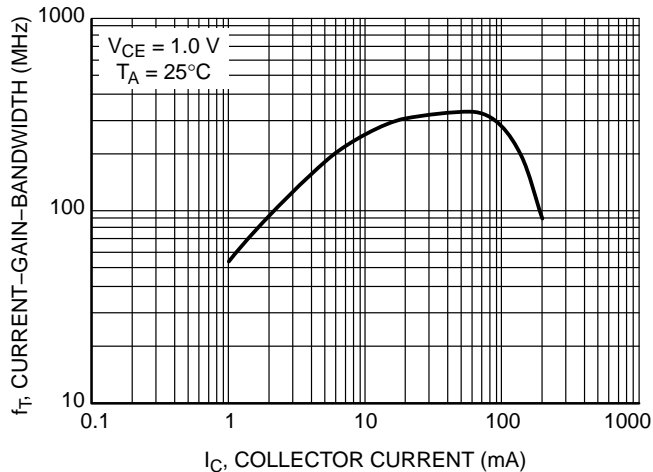

**Figure 21. Current-Gain-Bandwidth Product**

# MECHANICAL CASE OUTLINE

## PACKAGE DIMENSIONS

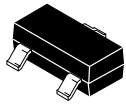

**SOT-23 (TO-236)**  
**CASE 318**  
**ISSUE AT**

DATE 01 MAR 2023

SCALE 4:1

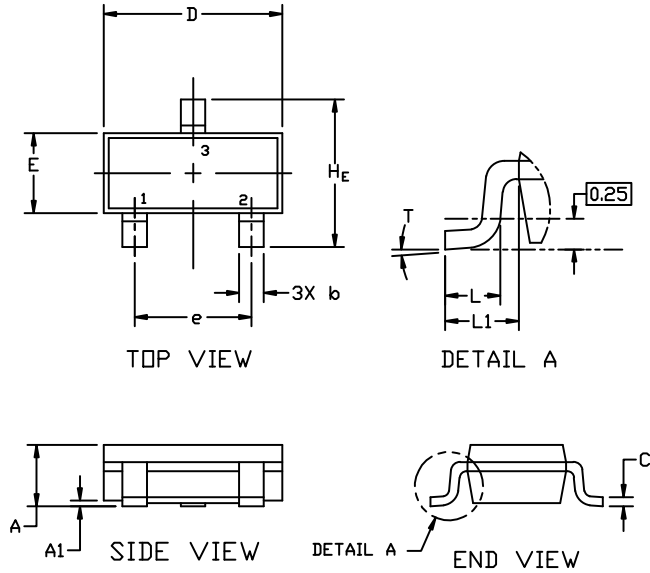

**NOTES:**

1. DIMENSIONING AND TOLERANCING PER ASME Y14.5M,1994.
2. CONTROLLING DIMENSION: MILLIMETERS
3. MAXIMUM LEAD THICKNESS INCLUDES LEAD FINISH. MINIMUM LEAD THICKNESS IS THE MINIMUM THICKNESS OF THE BASE MATERIAL.
4. DIMENSIONS D AND E DO NOT INCLUDE MOLD FLASH, PROTRUSIONS, OR GATE BURRS.

DIM	MILLIMETERS			INCHES		
	MIN.	NOM.	MAX.	MIN.	NOM.	MAX.
A	0.89	1.00	1.11	0.035	0.039	0.044
A1	0.01	0.06	0.10	0.000	0.002	0.004
b	0.37	0.44	0.50	0.015	0.017	0.020
c	0.08	0.14	0.20	0.003	0.006	0.008
D	2.80	2.90	3.04	0.110	0.114	0.120
E	1.20	1.30	1.40	0.047	0.051	0.055
e	1.78	1.90	2.04	0.070	0.075	0.080
L	0.30	0.43	0.55	0.012	0.017	0.022
L1	0.35	0.54	0.69	0.014	0.021	0.027
H <sub>E</sub>	2.10	2.40	2.64	0.083	0.094	0.104
T	0°	---	10°	0°	---	10°

**GENERIC MARKING DIAGRAM\***



- XXX = Specific Device Code
- M = Date Code
- = Pb-Free Package

\*This information is generic. Please refer to device data sheet for actual part marking. Pb-Free indicator, "G" or microdot "▪", may or may not be present. Some products may not follow the Generic Marking.

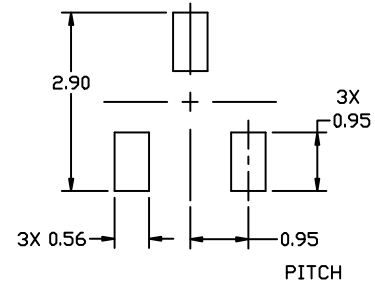

**RECOMMENDED MOUNTING FOOTPRINT**

\* For additional information on our Pb-Free strategy and soldering details, please download the ON Semiconductor Soldering and Mounting Techniques Reference Manual, SOLDERRM/D.

**STYLES ON PAGE 2**

<b>DOCUMENT NUMBER:</b>	<b>98ASB42226B</b>	Electronic versions are uncontrolled except when accessed directly from the Document Repository. Printed versions are uncontrolled except when stamped "CONTROLLED COPY" in red.
<b>DESCRIPTION:</b>	<b>SOT-23 (TO-236)</b>	<b>PAGE 1 OF 2</b>

onsemi and ONSEMI are trademarks of Semiconductor Components Industries, LLC dba onsemi or its subsidiaries in the United States and/or other countries. onsemi reserves the right to make changes without further notice to any products herein. onsemi makes no warranty, representation or guarantee regarding the suitability of its products for any particular purpose, nor does onsemi assume any liability arising out of the application or use of any product or circuit, and specifically disclaims any and all liability, including without limitation special, consequential or incidental damages. onsemi does not convey any license under its patent rights nor the rights of others.

# MECHANICAL CASE OUTLINE

## PACKAGE DIMENSIONS



### SOT-23 (TO-236) CASE 318 ISSUE AT

DATE 01 MAR 2023

STYLE 1 THRU 5: CANCELLED	STYLE 6: PIN 1. BASE 2. EMITTER 3. COLLECTOR	STYLE 7: PIN 1. EMITTER 2. BASE 3. COLLECTOR	STYLE 8: PIN 1. ANODE 2. NO CONNECTION 3. CATHODE		
STYLE 9: PIN 1. ANODE 2. ANODE 3. CATHODE	STYLE 10: PIN 1. DRAIN 2. SOURCE 3. GATE	STYLE 11: PIN 1. ANODE 2. CATHODE 3. CATHODE-ANODE	STYLE 12: PIN 1. CATHODE 2. CATHODE 3. ANODE	STYLE 13: PIN 1. SOURCE 2. DRAIN 3. GATE	STYLE 14: PIN 1. CATHODE 2. GATE 3. ANODE
STYLE 15: PIN 1. GATE 2. CATHODE 3. ANODE	STYLE 16: PIN 1. ANODE 2. CATHODE 3. CATHODE	STYLE 17: PIN 1. NO CONNECTION 2. ANODE 3. CATHODE	STYLE 18: PIN 1. NO CONNECTION 2. CATHODE 3. ANODE	STYLE 19: PIN 1. CATHODE 2. ANODE 3. CATHODE-ANODE	STYLE 20: PIN 1. CATHODE 2. ANODE 3. GATE
STYLE 21: PIN 1. GATE 2. SOURCE 3. DRAIN	STYLE 22: PIN 1. RETURN 2. OUTPUT 3. INPUT	STYLE 23: PIN 1. ANODE 2. ANODE 3. CATHODE	STYLE 24: PIN 1. GATE 2. DRAIN 3. SOURCE	STYLE 25: PIN 1. ANODE 2. CATHODE 3. GATE	STYLE 26: PIN 1. CATHODE 2. ANODE 3. NO CONNECTION
STYLE 27: PIN 1. CATHODE 2. CATHODE 3. CATHODE	STYLE 28: PIN 1. ANODE 2. ANODE 3. ANODE				

<b>DOCUMENT NUMBER:</b>	<b>98ASB42226B</b>	Electronic versions are uncontrolled except when accessed directly from the Document Repository. Printed versions are uncontrolled except when stamped "CONTROLLED COPY" in red.
<b>DESCRIPTION:</b>	<b>SOT-23 (TO-236)</b>	<b>PAGE 2 OF 2</b>

**onsemi** and **ONSEMI** are trademarks of Semiconductor Components Industries, LLC dba **onsemi** or its subsidiaries in the United States and/or other countries. **onsemi** reserves the right to make changes without further notice to any products herein. **onsemi** makes no warranty, representation or guarantee regarding the suitability of its products for any particular purpose, nor does **onsemi** assume any liability arising out of the application or use of any product or circuit, and specifically disclaims any and all liability, including without limitation special, consequential or incidental damages. **onsemi** does not convey any license under its patent rights nor the rights of others.



**onsemi**, **Onsemi**, and other names, marks, and brands are registered and/or common law trademarks of Semiconductor Components Industries, LLC dba "**onsemi**" or its affiliates and/or subsidiaries in the United States and/or other countries. **onsemi** owns the rights to a number of patents, trademarks, copyrights, trade secrets, and other intellectual property. A listing of **onsemi**'s product/patent coverage may be accessed at [www.onsemi.com/site/pdf/Patent-Marking.pdf](http://www.onsemi.com/site/pdf/Patent-Marking.pdf). **onsemi** reserves the right to make changes at any time to any products or information herein, without notice. The information herein is provided "as-is" and **onsemi** makes no warranty, representation or guarantee regarding the accuracy of the information, product features, availability, functionality, or suitability of its products for any particular purpose, nor does **onsemi** assume any liability arising out of the application or use of any product or circuit, and specifically disclaims any and all liability, including without limitation special, consequential or incidental damages. Buyer is responsible for its products and applications using **onsemi** products, including compliance with all laws, regulations and safety requirements or standards, regardless of any support or applications information provided by **onsemi**. "Typical" parameters which may be provided in **onsemi** data sheets and/or specifications can and do vary in different applications and actual performance may vary over time. All operating parameters, including "Typicals" must be validated for each customer application by customer's technical experts. **onsemi** does not convey any license under any of its intellectual property rights nor the rights of others. **onsemi** products are not designed, intended, or authorized for use as a critical component in life support systems or any FDA Class 3 medical devices or medical devices with a same or similar classification in a foreign jurisdiction or any devices intended for implantation in the human body. Should Buyer purchase or use **onsemi** products for any such unintended or unauthorized application, Buyer shall indemnify and hold **onsemi** and its officers, employees, subsidiaries, affiliates, and distributors harmless against all claims, costs, damages, and expenses, and reasonable attorney fees arising out of, directly or indirectly, any claim of personal injury or death associated with such unintended or unauthorized use, even if such claim alleges that **onsemi** was negligent regarding the design or manufacture of the part. **onsemi** is an Equal Opportunity/Affirmative Action Employer. This literature is subject to all applicable copyright laws and is not for resale in any manner.

---

## ADDITIONAL INFORMATION

### TECHNICAL PUBLICATIONS:

Technical Library: [www.onsemi.com/design/resources/technical-documentation](http://www.onsemi.com/design/resources/technical-documentation)  
onsemi Website: [www.onsemi.com](http://www.onsemi.com)

### ONLINE SUPPORT: [www.onsemi.com/support](http://www.onsemi.com/support)

For additional information, please contact your local Sales Representative at [www.onsemi.com/support/sales](http://www.onsemi.com/support/sales)