

APPROVED: _____
 DATE: _____ TITLE: _____

Rev	AWO #	Description	Date	Appr
-		RELEASED	11/1/22	
A		UPDATED SPEC.	11/30/22	JJ/RC

D

C

B

A

Ⓐ Lock Nut

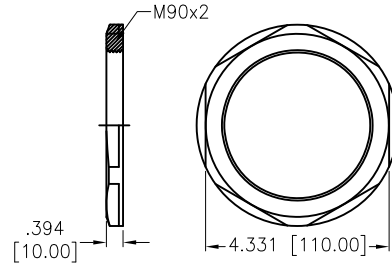

Ⓑ Washer

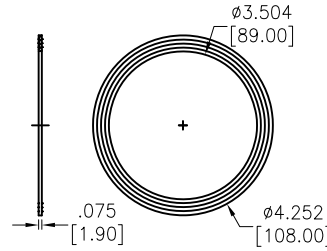

Ⓒ Body

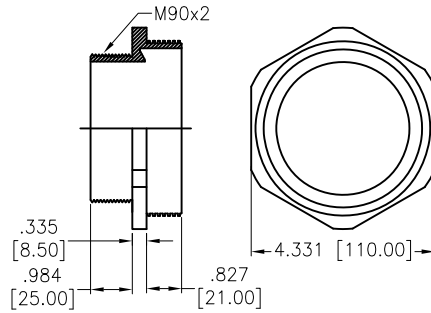

Ⓓ Seal

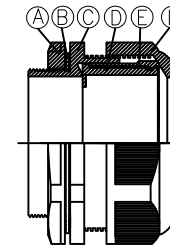
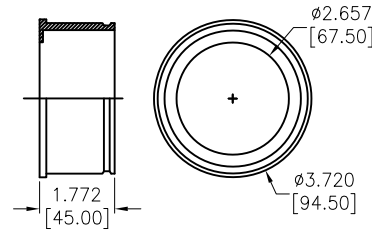

Ⓔ Claw

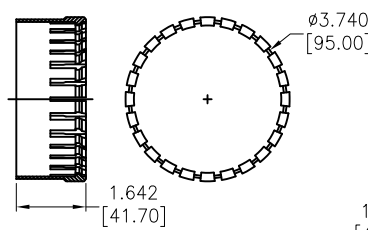

Ⓕ Sealing Nut

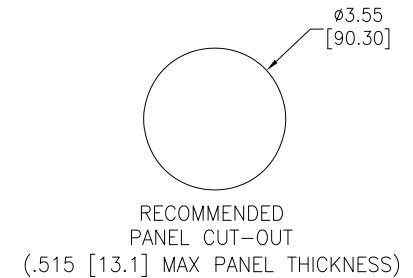
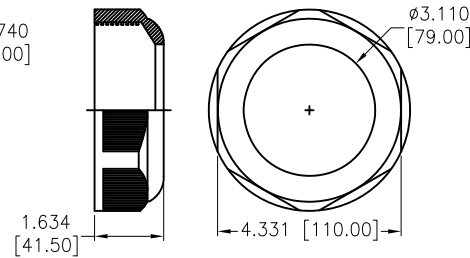

SPECIFICATIONS:

Material:
 Lock Nut: PA66, rated UL 94V-2
 Body: PA66, rated UL 94V-2
 Sealing Nut: PA66, rated UL 94V-2
 Claw: PA66, rated UL 94V-2
 Washer: NBR
 Seal: NBR
 Mechanical:
 Cable Range O.D.: 66-77mm
 Thread O.D. L2: 90mm
 Thread Length L2: 25mm
 Spanner Size A&E: 111/110mm
 Nut Torque: 5Nm Max.
 Environmental:
 Waterproof: IP68
 Lead free, RoHS compliant.



UNLESS OTHERWISE SPECIFIED ALL DIMENSIONS ARE INCHES [MM]. TOLERANCES: EXCEPT AS NOTED

INCHES		HOLES	
.X	± .10	ØX	± .10
.XX	± .020	ØXX	± .015
.XXX	± .015	ØXXX	± .010



909 Rahway Avenue,
 Union, NJ 07083
 Phone: 908-687-5000
 Fax: 908-687-5710

DRAWN	WX	11/1/22
CHECKED	RC	11/1/22
APPROVED		

TITLE	WATERPROOF CONNECTOR, M90, 1 HOLE, CABLE GLAND, WATERPROOF: IP68		
SIZE	PART NO.	REV.	
X	CG-P-M90-2.0	A	

THIS DRAWING CONTAINS INFORMATION THAT IS PROPRIETARY AND SHOULD NOT BE USED WITHOUT PRIOR WRITTEN PERMISSION FROM ADAM TECH

REF:	S00211C	SCALE:	NTS	SHEET	1 OF 1
------	---------	--------	-----	-------	--------

6

5

4

3

2

1

6

5

4

3

2

1