

ACPDUC5V0-HF

RoHS Device
Halogen Free



Features

- Bi-directional ESD protection.
- IEC61000-4-2 Level 4 ESD protection.
- Ultra small SMD package.
- Surface mount package.
- High component density.
- Comply with AEC-Q101

Mechanical data

- Case: 0603C/SOD-523F standard package, molded plastic.
- Terminals: Matte tin plated, Solderable per MIL-STD-750, Method 2026.
- Marking Code: E5
- Mounting position: Any.
- Weight: 0.003 grams(approx.).

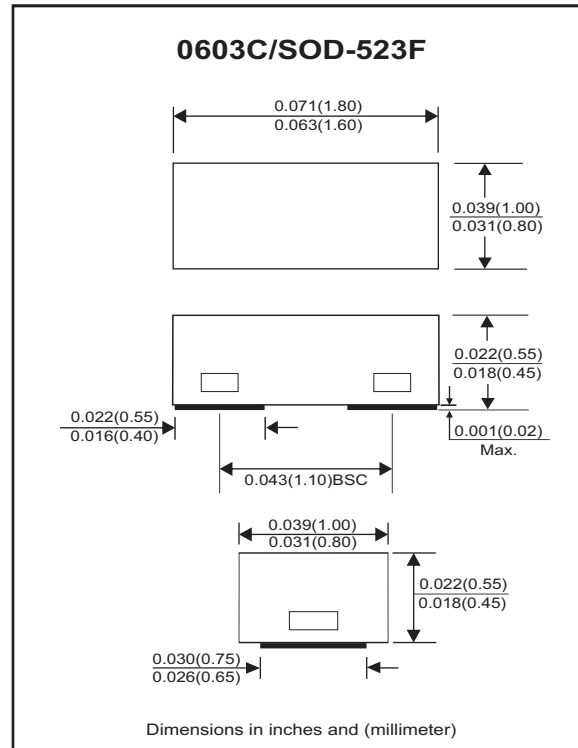

Circuit diagram



Maximum Rating And Electrical Characteristics (at TA=25°C unless otherwise noted)

Parameter	Conditions	Symbol	Min	Typ	Max	Unit
Diode breakdown voltage	I _R = 1mA	V _{BD}	5.1	7.0		V
Leakage current	V _R = 5V	I _L		0.1	2.0	uA
Junction capacitance	V _R = 0V, f = 1MHz	C _T		15	20	pF
ESD capability	IEC 61000-4-2(Air)	ESD			16	kV
	IEC 61000-4-2(Contact)	ESD			8	kV
Clamping voltage	I _{PP} = 5A, T _P = 8/20us	V _C			15	V
Peak pulse power	T _P = 8/20us	P _{PP}			75	W
Operation temperature		T _j	-40		125	°C
Storage temperature		T _{STG}	-55		150	°C

RATING AND CHARACTERISTIC CURVES (ACPDUC5V0-HF)

Fig.1 - 8/20us Peak Pulse Current Waveform acc. IEC 61000-4-5

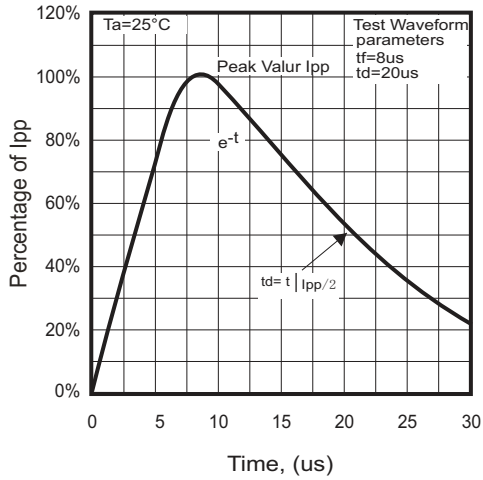

Fig. 2 - Reverse characteristics

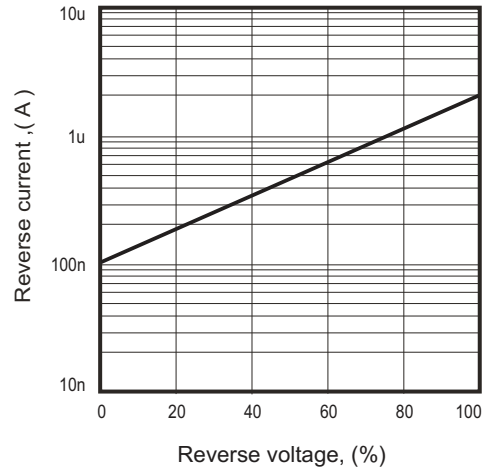

Fig. 3 - Capacitance between terminals characteristics

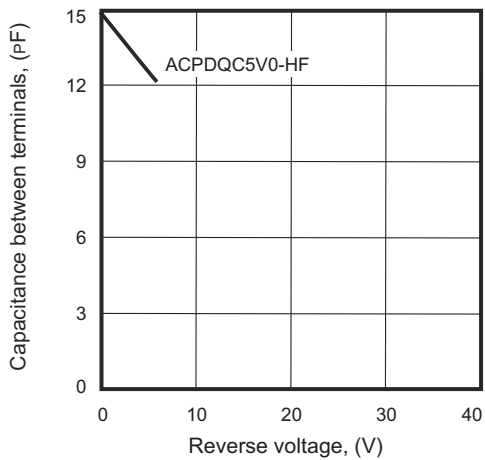
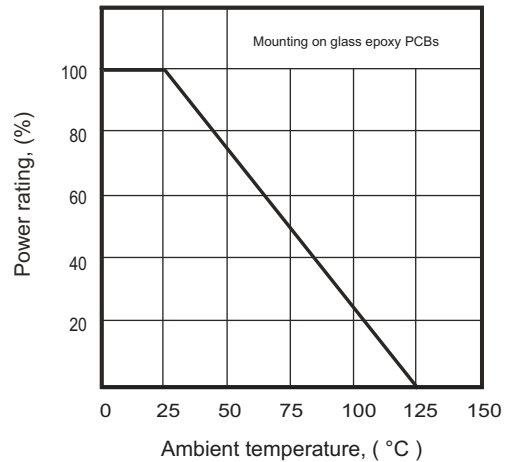
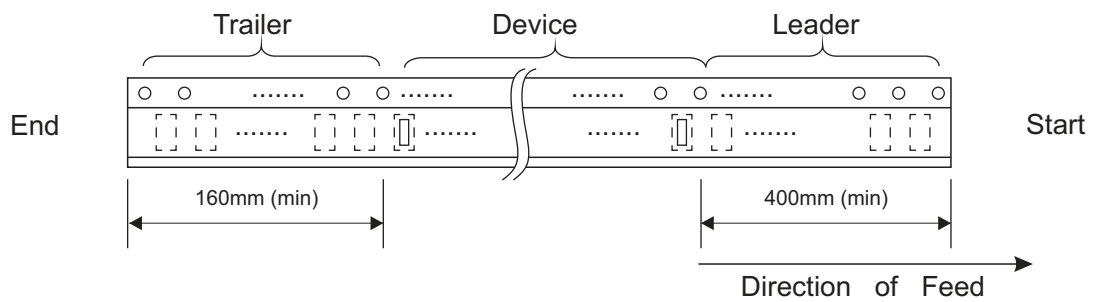
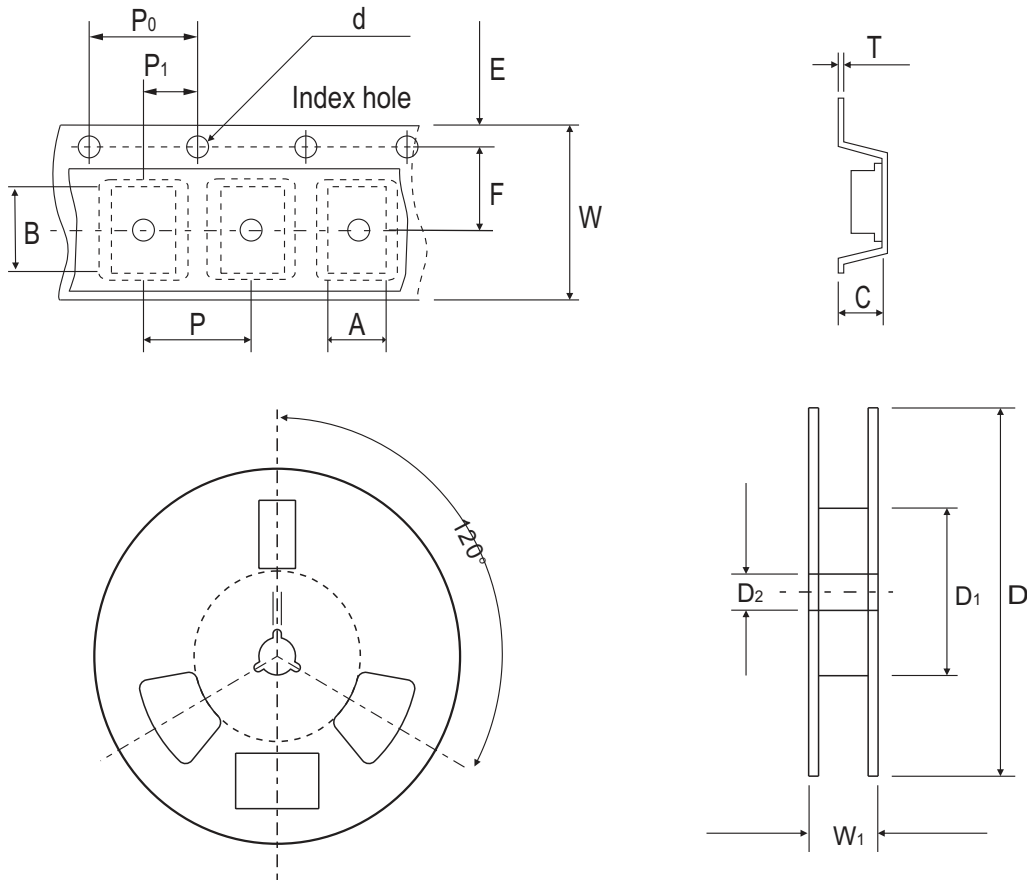

Fig. 4 - Power rating derating curve



Reel Taping Specification



0603C/ SOD-523F	SYMBOL	A	B	C	d	D	D ₁	D ₂
	(mm)	1.05 ± 0.05	1.96 ± 0.05	0.57 ± 0.05	1.50 ^{+0.10} ₋₀	178.00 ± 1.00	60.00 ± 0.50	13.50 ± 0.20
	(inch)	0.041 ± 0.002	0.077 ± 0.002	0.022 ± 0.002	0.059 ^{+0.004} ₋₀	7.008 ± 0.039	2.362 ± 0.020	0.531 ± 0.008

0603C/ SOD-523F	SYMBOL	E	F	P	P ₀	P ₁	T	W	W ₁
	(mm)	1.75 ± 0.10	3.50 ± 0.05	4.00 ± 0.10	4.00 ± 0.05	2.00 ± 0.05	0.20 ± 0.03	8.00 ± 0.20	12.00 ^{+0.50} ₋₀
	(inch)	0.069 ± 0.004	0.138 ± 0.002	0.157 ± 0.004	0.157 ± 0.002	0.079 ± 0.002	0.008 ± 0.001	0.315 ± 0.008	0.472 ^{+0.020} ₋₀

Marking Code

Part Number	Marking Code
ACPDUC5V0-HF	E05

E05

Suggested PAD Layout

SIZE	0603C/SOD-523F	
	(mm)	(inch)
A	1.10	0.043
B	0.70	0.028
C	1.00	0.039
D	1.80	0.071
E	0.40	0.016

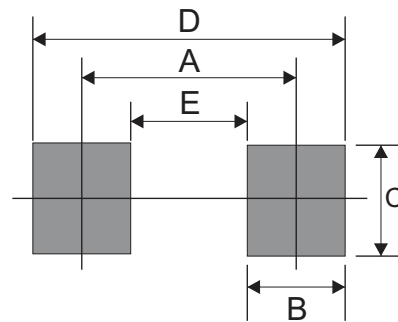

Standard Packaging

Case Type	REEL PACK	
	REEL (pcs)	Reel Size (inch)
0603C/SOD-523F	4,000	7