

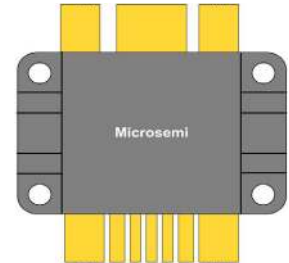

MOSFET Driver Hybrid

The DRF1200 hybrid includes a high power gate driver and the power MOSFET. The driver output can be configured as Inverting and Non-Inverting. It was designed to provide the system designer increased flexibility and lowered cost over a non-integrated solution.

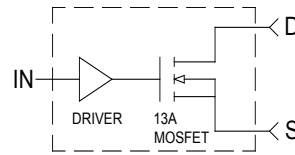

FEATURES

- Switching Frequency: DC TO 30MHz
- Low Pulse Width Distortion
- Single Power Supply
- 1V CMOS Schmitt Trigger Input 1V Hysteresis
- Inverting Non-Inverting Select
- RoHS Compliant 
- Switching Speed 3-4ns
- $B_{V_{ds}} = 1Kv$
- $I_{ds} = 13A$ Max
- $R_{ds(on)} \leq 0.90$ Ohm
- $P_D = 624W$

TYPICAL APPLICATIONS

- Class C, D and E RF Generators
- Switch Mode Power Amplifiers
- Pulse Generators
- Ultrasound Transducer Drivers
- Acoustic Optical Modulators

Driver Absolute Maximum Ratings

Symbol	Parameter	Min	Typ	Max	Unit
V_{DD}	Supply Voltage			15	V
IN, FN	Input Single Voltages			-.7 to +5.5	
$I_{O_{PK}}$	Output Current Peak			8	A
T_{JMAX}	Operating Temperature			175	°C

Driver Specifications

Symbol	Parameter	Min	Typ	Max	Unit
V_{DD}	Supply Voltage	10		15	V
IN	Input Voltage	3		5.5	
$IN_{(R)}$	Input Voltage Rising Edge		3		ns
$IN_{(F)}$	Input Voltage Falling Edge		3		
I_{DDQ}	Quiescent Current		2		mA
I_O	Output Current		8		A
C_{iss}	Input Capacitance		3		
R_{IN}	Input Parallel Resistance		1		MΩ
$V_{TH(on)}$	Input, Voltage Threshold Low (See truth table)	0.8		1.1	V
$V_{TH(off)}$	Input, Voltage Threshold High (See truth table)	1.9		2.2	
T_{DLY}	Time Delay (throughput)		38		ns
t_r	Rise Time		2.5		ns
t_f	Fall Time		2.5		

Driver Output Characteristics

Symbol	Parameter	Min	Typ	Max	Unit
C_{out}	Output Capacitance		2500		pF
R_{out}	Output Resistance		.8		Ω
L_{out}	Output Inductance		3		nH
F_{MAX}	Operating Frequency CL = 3000nF + 50 Ω	30			MHz
F_{MAX}	Operating Frequency RL = 50 Ω	50			

Driver Thermal Characteristics

Symbol	Parameter	Min	Typ	Max	Unit
$R_{\theta JC}$	Thermal Resistance Junction to Case		1.5		$^{\circ}\text{C}/\text{W}$
$R_{\theta JHS}$	Thermal Resistance Junction to Heat Sink		2.5		
T_{JSTG}	Storage Temperature		-55 to 150		$^{\circ}\text{C}$
P_{DJHS}	Maximum Power Dissipation @ $T_{SINK} = 25^{\circ}\text{C}$		60		W
P_{DJC}	Total Power Dissipation @ $T_C = 25^{\circ}\text{C}$		100		

MOSFET Absolute Maximum Ratings

Symbol	Parameter	Min	Typ	Max	Unit
BV_{DSS}	Drain Source Voltage	1000			V
I_D	Continuous Drain Current $T_C = 25^{\circ}\text{C}$ @ $I_D 10\text{A}$			20	A
$R_{DS(on)}$	Drain-Source On State Resistance			0.90	Ω
T_{Jmax}	Operating Temperature			175	$^{\circ}\text{C}$

MOSFET Dynamic Characteristics

Symbol	Parameter	Test Conditions	Min	Typ	Max	Unit
C_{iss}	Input Capacitance	$V_{gs} = 0$ $V_{DS} = 50\text{V}$ $f = 1\text{MHz}$		2300		pF
C_{oss}	Output Capacitance			260		
C_{rss}	Reverse Transfer Capacitance			100		

MOSFET Thermal Characteristics

Symbol	Parameter	Min	Typ	Max	Unit
$R_{\theta JC}$	Thermal Resistance Junction to Case			0.13	$^{\circ}\text{C}/\text{W}$
$R_{\theta JHS}$	Thermal Resistance Junction to Heat Sink			0.25	
T_{JSTG}	Storage Temperature			-55 to 150	$^{\circ}\text{C}$
P_{DHS}	Maximum Power Dissipation @ $T_{SINK} = 25^{\circ}\text{C}$			600	W
P_{DC}	Total Power Dissipation @ $T_C = 25^{\circ}\text{C}$			1150	

Microsemi reserves the right to change, without notice, the specifications and information contained herein.

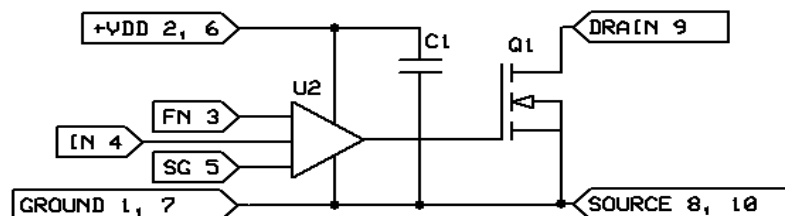

Figure 1, DRF1200 Simplified Circuit Diagram

The Simplified DRF1200 Circuit Diagram is illustrated above. By including the driver high speed by-pass capacitor (C1), the contribution to the internal parasitic loop inductance of the driver output is greatly reduced. This, coupled with the tight geometry of the hybrid, allows optimal gate drive to the MOSFET. This low parasitic approach, coupled with the Schmitt trigger input (IN), Kelvin signal ground (SG) and the Anti-Ring Function, provide improved stability and control in Kilowatt to Multi-Kilowatt, high Frequency applications. Both the FN and IN pins are referenced to the Kelvin ground (SG.) The signal is then applied to the intermediate drivers and level shifters; this section contains proprietary circuitry designed specifically for the ring abatement. The power drivers provide high current to the gate of the MOSFETS.

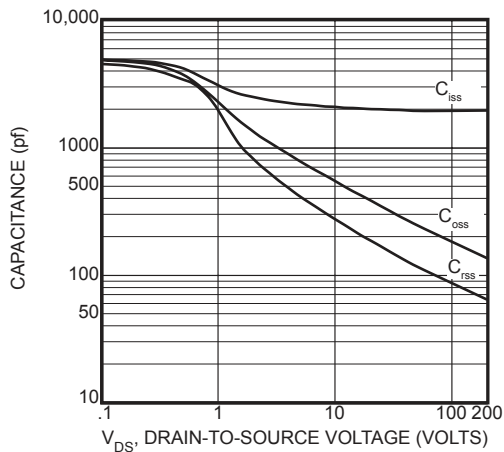

Figure 2, Typical Capacitance vs. Drain-to-Source Voltage

Truth Table *Referenced to SG		
FN (pin 3)*	IN (pin 4)*	MOSFET
HIGH	HIGH	ON
HIGH	LOW	OFF
LOW	HIGH	OFF
LOW	LOW	ON

The Function (FN, pin 3) is the invert or non-invert select Pin, it is Internally held high.

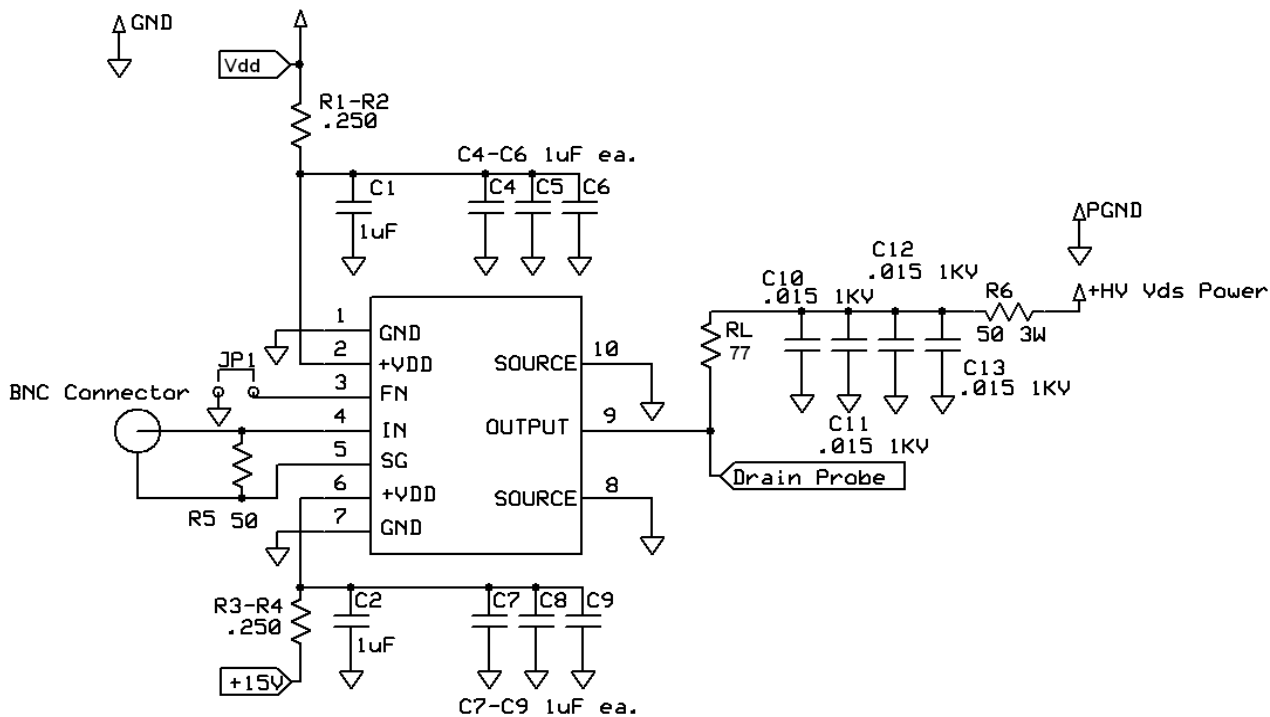
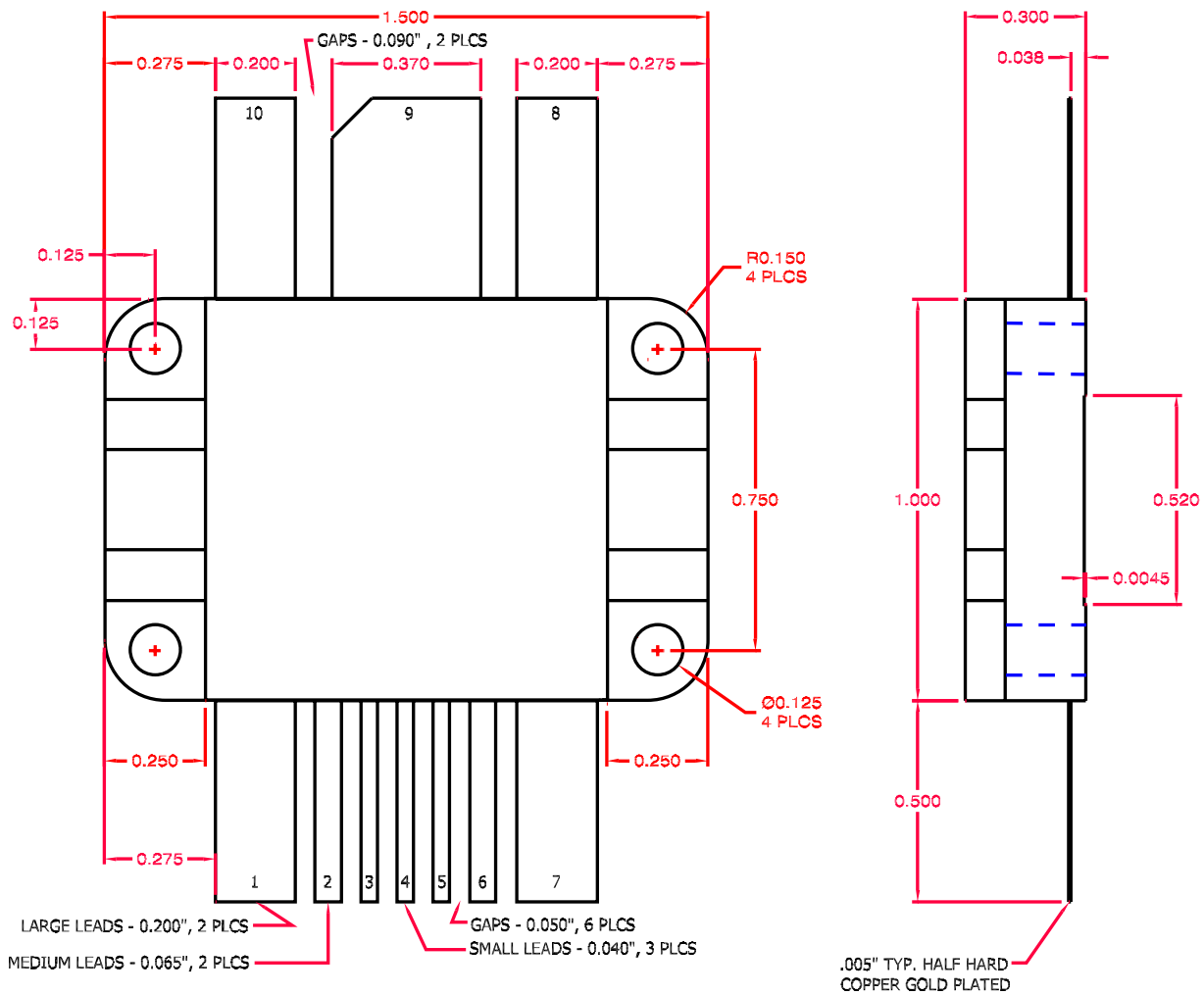

Figure 3, DRF1200 Test Circuit

The Test Circuit illustrated above was used to evaluate the DRF1200 (available as an evaluation Board DRF12XX / EVALSW.) The input control signal is applied to the DRF1200 via IN(4) and SG(5) pins using RG188. This provides excellent noise immunity and control of the signal ground currents.

The +V_{DD} inputs (2,6) are by-passed (C1, C2, C4-C9), this is in addition to the internal by-passing mentioned previously. The capacitors used for this function must be capable of supporting the RMS currents and frequency of the gate load. R_L set for I_{DM} at V_{DS} max this load is used to evaluate the output performance of the DRF1201.

Pin Assignments	
Pin 1	Ground
Pin 2	+Vdd
Pin 3	FN
Pin 4	IN
Pin 5	SG
Pin 6	+Vdd
Pin 7	Ground
Pin 8	Source
Pin 9	Drain
Pin 10	Source



All dimensions are ± .005

Figure 4, DRF1200 Mechanical Outline

HAZARDOUS MATERIAL WARNING

The ceramic portion of the device between leads and mounting flange is beryllium oxide. Beryllium oxide dust is highly toxic when inhaled. Care must be taken during handling and mounting to avoid damage to this area. These devices must never be thrown away with general industrial or domestic waste. BeO substrate weight: 1.973g. Percentage of total module weight which is BeO: 31%.

Disclaimer:

The information contained in the document (unless it is publicly available on the Web without access restrictions) is PROPRIETARY AND CONFIDENTIAL information of Microsemi and cannot be copied, published, uploaded, posted, transmitted, distributed or disclosed or used without the express duly signed written consent of Microsemi. If the recipient of this document has entered into a disclosure agreement with Microsemi, then the terms of such Agreement will also apply. This document and the information contained herein may not be modified, by any person other than authorized personnel of Microsemi. No license under any patent, copyright, trade secret or other intellectual property right is granted to or conferred upon you by disclosure or delivery of the information, either expressly, by implication, inducement, estoppels or otherwise. Any license under such intellectual property rights must be approved by Microsemi in writing signed by an officer of Microsemi.

Microsemi reserves the right to change the configuration, functionality and performance of its products at anytime without any notice. This product has been subject to limited testing and should not be used in conjunction with life-support or other mission-critical equipment or applications. Microsemi assumes no liability whatsoever, and Microsemi disclaims any express or implied warranty, relating to sale and/or use of Microsemi products including liability or warranties relating to fitness for a particular purpose, merchantability, or infringement of any patent, copyright or other intellectual property right. Any performance specifications believed to be reliable but are not verified and customer or user must conduct and complete all performance and other testing of this product as well as any user or customers final application. User or customer shall not rely on any data and performance specifications or parameters provided by Microsemi. It is the customer's and user's responsibility to independently determine suitability of any Microsemi product and to test and verify the same. The information contained herein is provided "AS IS, WHERE IS" and with all faults, and the entire risk associated with such information is entirely with the User. Microsemi specifically disclaims any liability of any kind including for consequential, incidental and punitive damages as well as lost profit. The product is subject to other terms and conditions which can be located on the web at <http://www.microsemi.com/legal/tnc.asp>