

PRODUCT NUMBER SEE SHEET 2

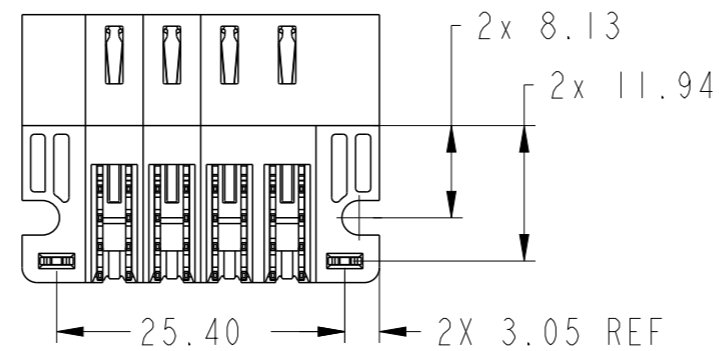

spec ref	*	dr	Rainbow Zhan	2015/08/30	projection	MM	size	A3	scale	3:2
tolerance std	ASME Y14.5	eng	Rainbow Zhan	2015/10/23			ecn no	-	rel level	Released
TOLERANCES UNLESS OTHERWISE SPECIFIED		chr	Fancy Zhang	2015/10/22						
surface	<input checked="" type="checkbox"/> linear <input type="checkbox"/> angular	0.X ±0.5 0.XX ±0.25 0.XXX ±0.10		title 4HDP RA STB HEADER	cat. no.	product family PwrBlade+	dwg no 10106132-4000001	rev A	Product - Customer Drw	
ASME Y14.5	angular	0° ±2°	www.fci.com						sheet 1 of 3	

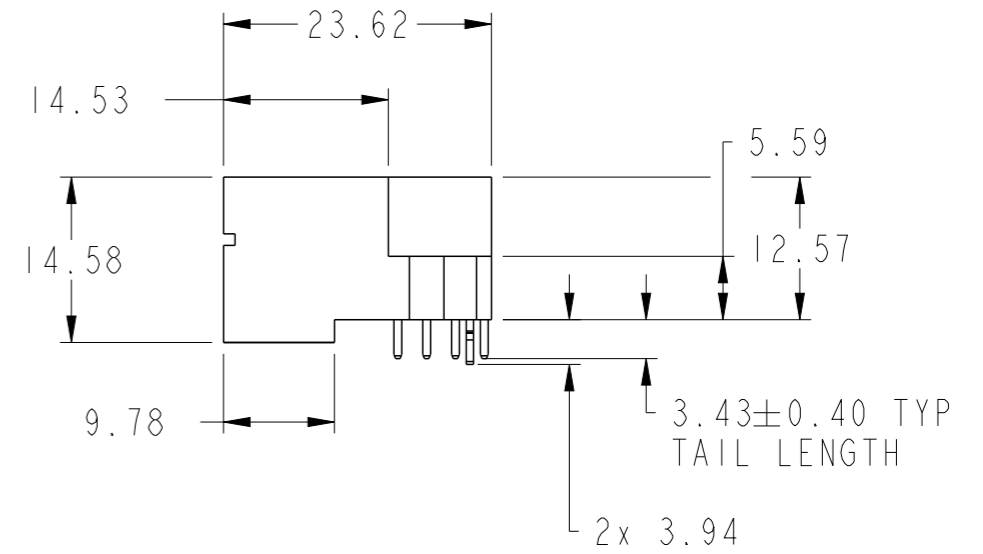
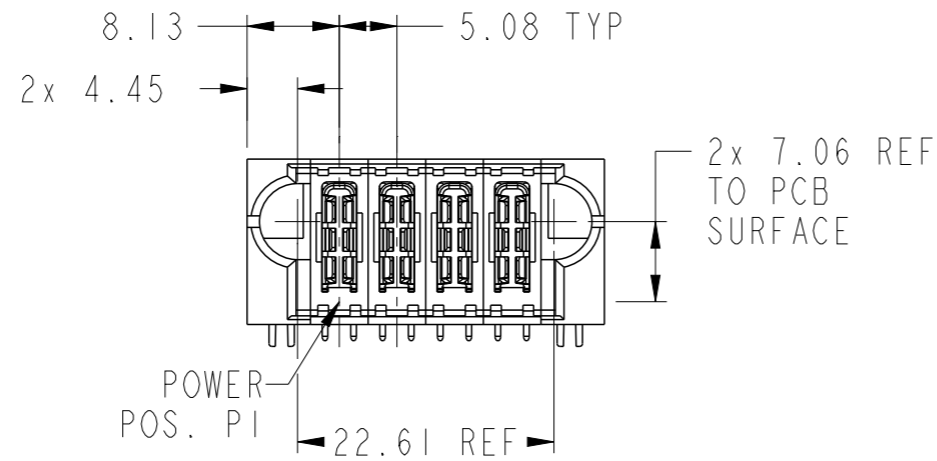
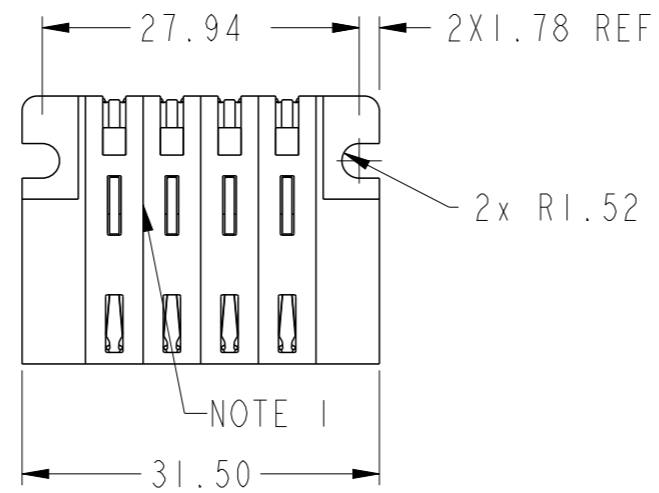

Copyright FCI.

PRODUCT NO.	ROWS	HIGH POWER				
		E1	P1	P2	P3	P4
10106132-4000001LF	D C B A					

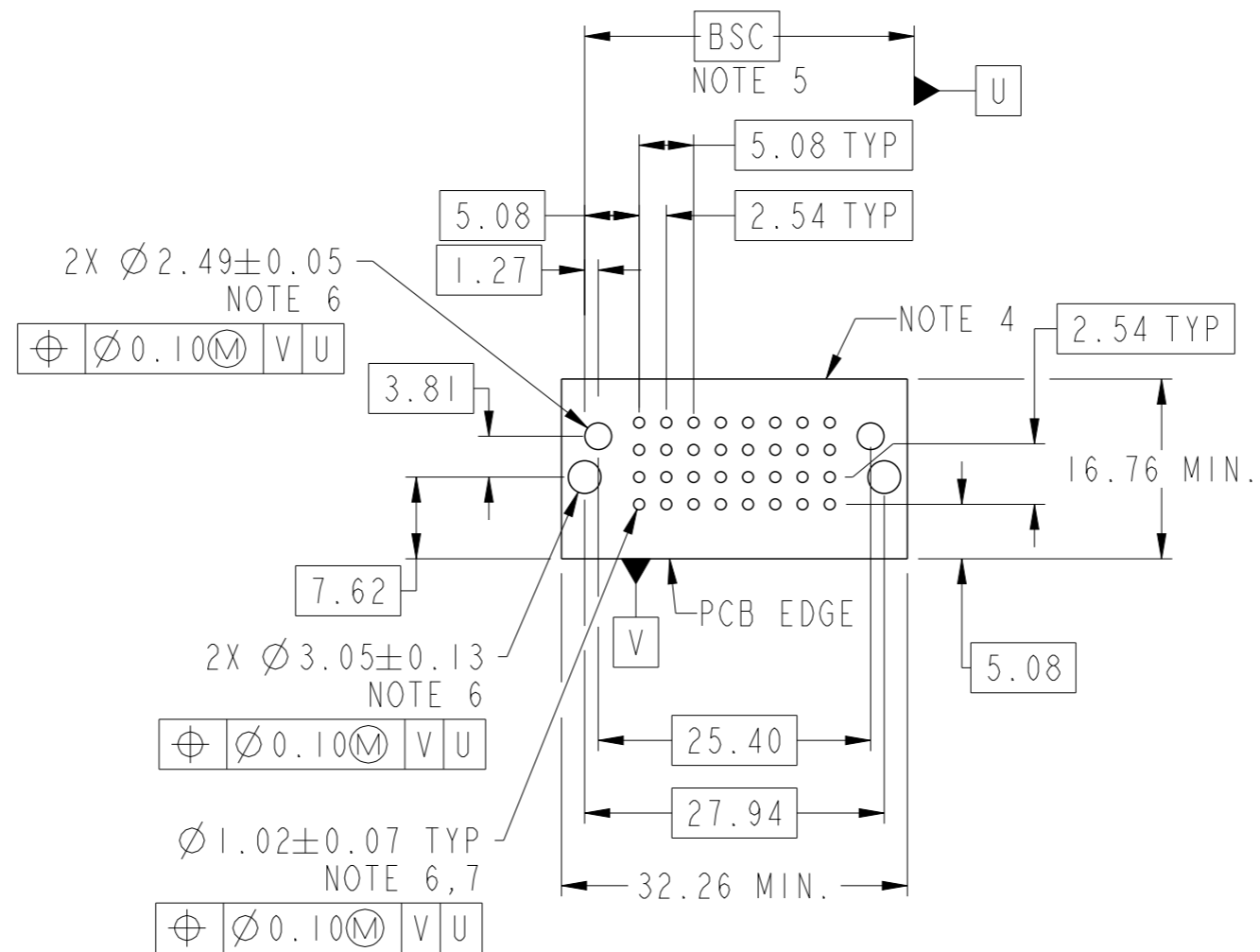

Copyright FCI.

CODE	DESCRIPTION
HI	STD HIGH POWER CONTACT (3.43)
HA	METAL HOLD DOWN



dr	Rainbow Zhan	2015/08/30	projection 	MM	size	A3	scale	3:2		
eng	Rainbow Zhan	2015/10/23			ecn no	-				
chr	Fancy Zhang	2015/10/22			rel level	Released				
appr	Pei-Ming Zheng	2015/10/23	product family	PwrBlade+						
			title	4HDP		dwg no	10106132-4000001		rev	A
www.fci.com			cat. no.	Product - Customer Drw			sheet 2 of 3			

NOTES:

- 1) "FCI", PART NUMBER AND DATE CODE TO BE MARKED ON THIS SURFACE.
THE MARK CAN BE OMITTED IF THERE IS NOT ENOUGH SPACE ON THIS SURFACE.
- 2) MATERIALS:
-HOUSING - GLASS FILLED WITH HIGH TEMP THERMOPLASTIC, UL94V-0.
-SIGNAL CONTACT - COPPER ALLOY.
-POWER CONTACT - HIGH CONDUCTIVITY COPPER ALLOY.
- 3) PLATING SPECIFICATION REFER TO FCI 10116351
- 4) DENOTES CONNECTOR KEEP OUT ZONE.
- 5) DATUM AND BASIC DIMENIONS WERE ESTABLISHED BY CUSTOMER.
- 6) ALL HOLE DIAMETERS ARE FINISHED HOLE SIZES.
- 7) 1.15 ± 0.025 MM DRILLED HOLE PLATED WITH 0.00762MM MIN Sn
OVER 0.0254-0.0762MM Cu PLATING TO ACHIEVE A 1.02 ± 0.07 MM HOLE.
- 8) PRODUCT SPECIFICATION REFER TO FCI GS-12-658.
APPLICATION SPECIFICATION REFER TO FCI GS-20-141.
PRODUCT PACKAGED IN TRAYS, REFER TO FCI GS-14-1502.

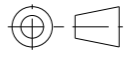
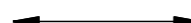

Copyright FCI.

dr	Rainbow Zhan	2015/08/30	projection 	MM 	size	A3	scale	3:2
eng	Rainbow Zhan	2015/10/23			ecn no	-		
chr	Fancy Zhang	2015/10/22			product family	PwrBlade+	rel level	Released
appr	Pei-Ming Zheng	2015/10/23			title 4HDP RA STB HEADER	dwg no 10106132-4000001	rev A	
www.fci.com			cat. no.	Product - Customer Drw		sheet 3 of 3		