

MAXIM

Direct-Conversion Tuner IC

MAX2108

General Description

The MAX2108 is a low-cost direct-conversion tuner IC designed for use in digital direct-broadcast satellite (DBS) television set-top box units and microwave links. Its direct-conversion architecture reduces system cost compared to devices with IF-based architectures.

The MAX2108 directly tunes L-band signals to base-band using a broadband I/Q downconverter. The operating frequency range spans from 950MHz to 2150MHz. The IC includes a low-noise amplifier (LNA) with gain control, two downconverter mixers with output buffers, a 90° quadrature generator, and a divide-by 32/33 prescaler.

Features

- ◆ Low-Cost Architecture
- ◆ Operates from Single +5V Supply
- ◆ On-Chip Quadrature Generator, Dual-Modulus Prescaler (/32, /33)
- ◆ Input Levels: -20dBm to -70dBm per Carrier
- ◆ Over 50dB RF Gain-Control Range
- ◆ 10dB Noise Figure at Maximum Gain
- ◆ +8dBm IIP3 at Minimum Gain

Applications

- DirectTV, PrimeStar, EchoStar DBS Tuners
- DVB-Compliant DBS Tuners
- Cellular Base Stations
- Wireless Local Loop
- Broadband Systems
- LMDS
- Microwave Links

Ordering Information

PART	TEMP RANGE	PIN-PACKAGE
MAX2108CEG	0°C to +70°C	24 QSOP
MAX2108CEG+	0°C to +70°C	24 QSOP

+Denotes lead-free package.

Pin Configuration appears at end of data sheet.

Functional Diagram

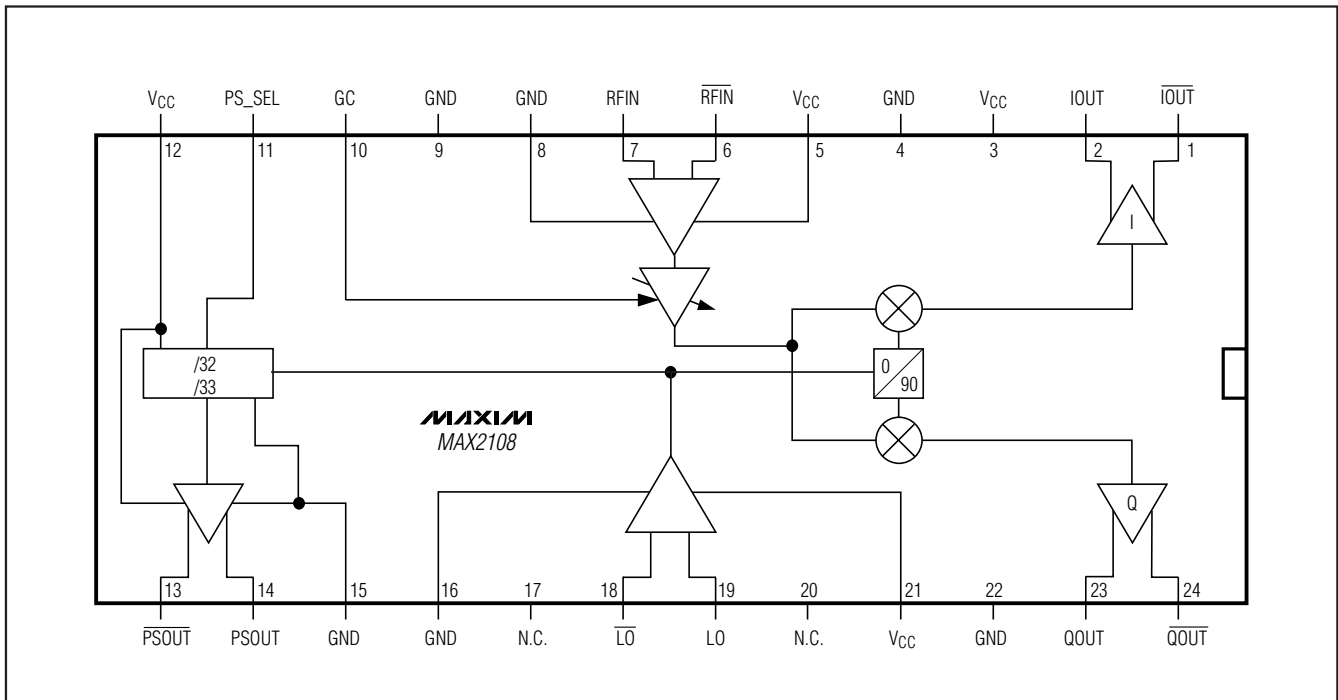

Direct-Conversion Tuner IC

ABSOLUTE MAXIMUM RATINGS

V _{CC} to GND	-0.3V to +7V	Short-Circuit Duration I _{OUT} to \overline{IOUT} , Q _{OUT} to \overline{QOUT} , PS _{OUT} to \overline{PSOUT}	10sec
V _{CC} to Any Other V _{CC}	-0.3V to +0.3V	Continuous Power Dissipation (T _A = +70°C)	24 QSOP (derate 10mW/°C above T _A = +70°C)
All Other Pins to GND	-0.3V to (V _{CC} + 0.3V)	Operating Temperature Range	0°C to +70°C
RFIN to RFIN	±2V	Junction Temperature	+150°C
LO to \overline{LO}	±2V	Storage Temperature Range	-65°C to +150°C
Short-Circuit Current		Lead Temperature (soldering, 10s)	+300°C
I _{OUT} , \overline{IOUT} , Q _{OUT} , \overline{QOUT} to GND	10mA		
PS _{OUT} , \overline{PSOUT} to GND	40mA		

Stresses beyond those listed under "Absolute Maximum Ratings" may cause permanent damage to the device. These are stress ratings only, and functional operation of the device at these or any other conditions beyond those indicated in the operational sections of the specifications is not implied. Exposure to absolute maximum rating conditions for extended periods may affect device reliability.

DC ELECTRICAL CHARACTERISTICS

(V_{CC} = +4.75V to +5.25V; V_{GC} = 1.3V; PS_SEL = 0.5V; I_{OUT}, \overline{IOUT} , Q_{OUT}, \overline{QOUT} = terminated with 2.5kΩ to GND; no input signal applied; T_A = 0°C to +70°C; unless otherwise noted. Typical values are at V_{CC} = +5V, T_A = +25°C.)

PARAMETER	SYMBOL	CONDITIONS	MIN	TYP	MAX	UNITS
Supply Current	I _{CC}			105	152	mA
PS_SEL Logic-High Threshold	V _{THH}		2.4			V
PS_SEL Logic-Low Threshold	V _{THL}				0.5	V
PS_SEL Input Bias Current	I _{PS_SEL}	0 < V _{PS_SEL} < V _{CC}	-30		+10	μA
GC Input Bias Current	I _{GC}	1V < V _{GC} < 4V	-80		+80	μA
I _{OUT} , \overline{IOUT} , Q _{OUT} , \overline{QOUT} Common-Mode Output Voltage	V _{CM}		2.9	3.35	3.8	V

AC ELECTRICAL CHARACTERISTICS

(V_{CC} = +5V; PS_SEL = 0.5V; P_{RFIN} = -20dBm; f_{LO} = f_{RFIN} + 125kHz; GC set via servo loop for V_{IOUT} - V \overline{IOUT} = 200mVp-p (differential); T_A = +25°C; unless otherwise noted.)

PARAMETER	SYMBOL	CONDITIONS	MIN	TYP	MAX	UNITS
RFIN Frequency Range (Note 1)	f _{RFIN}		950		2150	MHz
RFIN Maximum Input Power (Note 2)	P _{RFINMAX}	950MHz < f _{RFIN} < 2150MHz, P _{LO} = -5dBm	-20			dBm
RFIN Minimum Input Power (Note 2)	P _{RFINMIN}	950MHz < f _{RFIN} < 2150MHz, P _{LO} = -5dBm, V _{IOUT} - V \overline{IOUT} = 10mVp-p, T _A = 0°C +70°C			-70	dBm
External LO Drive Level (Note 2)				-5		dBm
Gain-Control Range (Note 2)		1V < V _{GC} < 4V, P _{LO} = -5dBm	50			dB
RFIN Input Third-Order Intercept Point (Note 3)	IIP ₃			8		dBm
RFIN Input Second-Order Intercept Point (Note 4)	IIP ₂			14		dBm
Noise Figure	NF	V _{GC} = 4V, f _{LO} = 1750MHz		10		dB

Direct-Conversion Tuner IC

MAX2108

AC ELECTRICAL CHARACTERISTICS (continued)

($V_{CC} = +5V$; $PS_SEL = 0.5V$; $PR_{FIN} = -20dBm$; $f_{LO} = f_{RFIN} + 125kHz$; GC set via servo loop for $V_{IOUT} - V_{\overline{IOUT}} = 200mVp-p$ (differential); $T_A = +25^{\circ}C$; unless otherwise noted.)

PARAMETER	SYMBOL	CONDITIONS	MIN	TYP	MAX	UNITS
Prescaler Divide Ratio		$V_{PS_SEL} > 2.4V$	32		32	
		$V_{PS_SEL} < 0.5V$	33		33	
Differential Prescaler Output Swing	$V_{PSOUT} - V_{\overline{PSOUT}}$	$C_{PSOUT} = C_{\overline{PSOUT}} = 10pF$ to GND	1.0			V_{P-P}
I/Q Channel Quadrature Phase Error (Note 2)		$f_{IOUT} = f_{\overline{IOUT}} = f_{QOUT} = f_{\overline{QOUT}} = 125kHz$			3	degrees
I/Q Amplitude Mismatch (Note 2)		$f_{IOUT} = f_{\overline{IOUT}} = f_{QOUT} = f_{\overline{QOUT}} = 125kHz$			1	dB
I/Q Channel Clipping Level		$f_{IOUT} = f_{\overline{IOUT}} = f_{QOUT} = f_{\overline{QOUT}} = 10MHz$, no output load		1.4		V_{P-P}
Baseband Bandwidth		At -3dB attenuation		150		MHz
I/Q Channel Differential Output Impedance		$f_{IOUT} = f_{\overline{IOUT}} = f_{QOUT} = f_{\overline{QOUT}} = 20MHz$		33		Ω

Note 1: AC specifications with minimum/maximum limits are met within this frequency range.

Note 2: LO and \overline{LO} are differentially driven through an AC-coupled matching network.

Note 3: $PR_{FIN} = -20dBm$ per tone, GC set via servo loop for $V_{IOUT} - V_{\overline{IOUT}} = 20mVp-p$ per tone. $f_{1RFIN} = 1749MHz$, $f_{2RFIN} = 1751MHz$, $f_{LO} = 1740MHz$.

Note 4: $PR_{FIN} = -20dBm$ per tone, GC set via servo loop for $V_{IOUT} - V_{\overline{IOUT}} = 20mVp-p$ per tone. $f_{1RFIN} = 1200MHz$, $f_{2RFIN} = 2150MHz$, $f_{LO} = 951MHz$.

Typical Operating Characteristics

($T_A = +25^{\circ}C$, unless otherwise noted.)

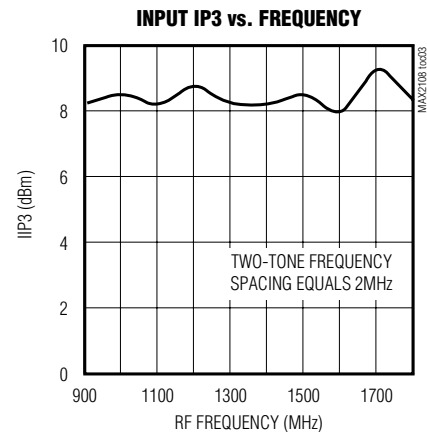
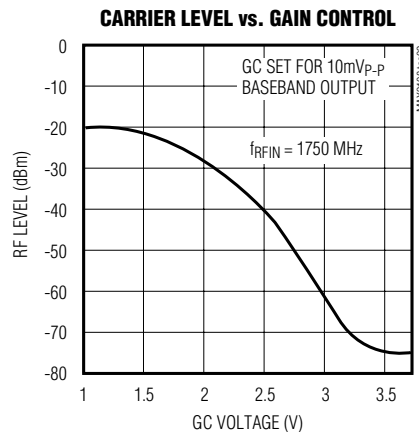
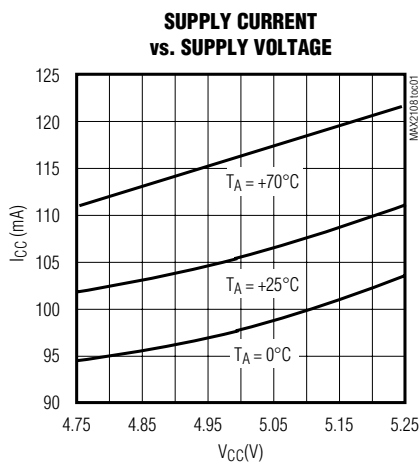

Direct-Conversion Tuner IC

Typical Operating Characteristics (continued)

($T_A = +25^\circ\text{C}$, unless otherwise noted.)

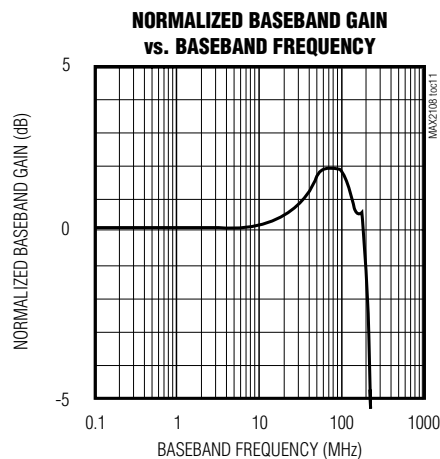
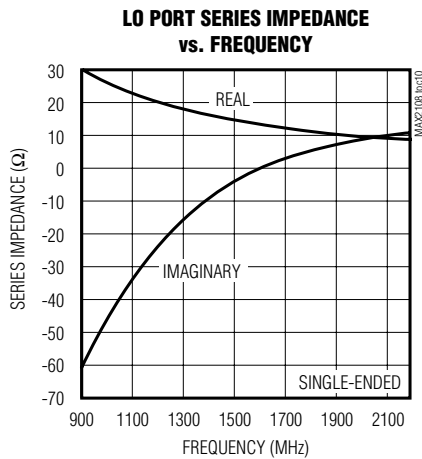
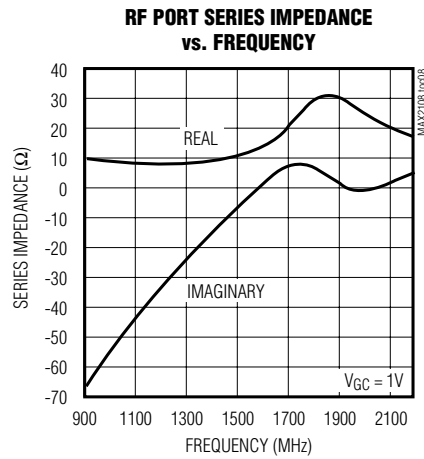
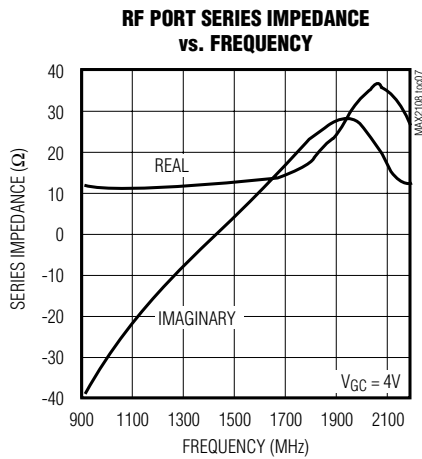
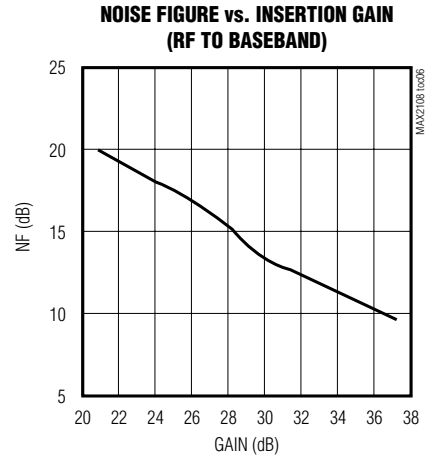
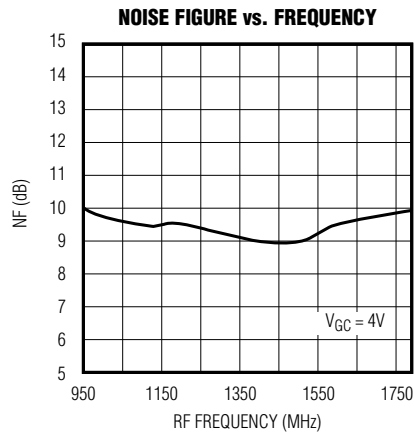
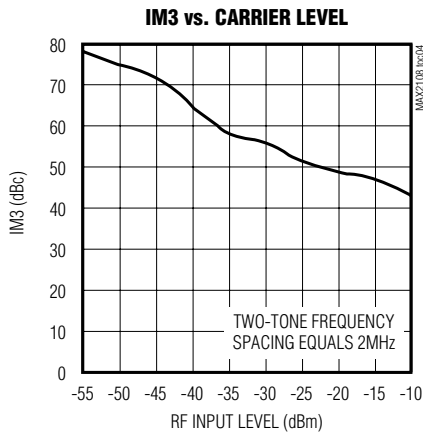

Direct-Conversion Tuner IC

Pin Description

MAX2108

PIN	NAME	FUNCTION
1	$\overline{\text{IOUT}}$	Inverting I-Channel Baseband Output
2	IOOUT	Noninverting I-Channel Baseband Output
3	VCC	Downconverter +5V Supply. Bypass with a 10pF capacitor to GND as close to the IC as possible. Connect an additional 0.1 μ F capacitor in parallel with the 10pF capacitor.
4	GND	Ground. Connect to a low-inductance ground plane.
5	VCC	RF +5V Supply. Bypass with a 22pF capacitor to GND as close to the IC as possible.
6	$\overline{\text{RFIN}}$	Inverting RF Input. Connect to a 22pF capacitor in series with a 75 Ω resistor to GND.
7	RFIN	Noninverting RF Input. Connect via matching network to a 75 Ω cable.
8, 9	GND	RF Ground. Connect to a low-inductance ground plane.
10	GC	Gain-Control Input. Apply a voltage between 1V and 4V to control the gain of the RF amplifier. Bypass with a 1000pF capacitor to minimize noise on the control line.
11	PS_SEL	Prescaler Modulus Control. Drive PS_SEL <0.5V to operate in divide-by-33 mode. Drive PS_SEL >2.4V to operate in divide-by-32 mode.
12	VCC	Prescaler +5V Supply. Bypass with a 1000pF capacitor to GND.
13	$\overline{\text{PSOUT}}$	Inverting Prescaler Output
14	PSOUT	Noninverting Prescaler Output
15	GND	Prescaler Ground. Connect to a low-inductance ground plane.
16	GND	Local Oscillator Ground. Connect to a low-inductance ground plane.
17, 20	N.C.	No Connection. Do not make any connection to this pin.
18	$\overline{\text{LO}}$	Inverting LO Input
19	LO	Noninverting LO Input
21	VCC	Local Oscillator +5V Supply. Bypass with a 22pF capacitor and a 0.1 μ F capacitor to pin 16.
22	GND	Downconverter Ground. Connect to a low-inductance ground plane.
23	QOUT	Noninverting Q-Channel Baseband Output
24	$\overline{\text{QOUT}}$	Inverting Q-Channel Baseband Output

Direct-Conversion Tuner IC

Detailed Description

The MAX2108 downconverts signals in the 950MHz to 2150MHz range directly to baseband in-phase/quadrature-phase (I/Q) signals. It is designed for digital DBS tuner applications where a direct downconversion provides a cost savings over multiple-conversion approaches. However, the MAX2108 is applicable to any system requiring a broadband I/Q downconversion.

Internally, the MAX2108 consists of a broadband front-end variable gain stage, a quadrature downconverter, a 90° quadrature generator, a divide-by 32/33 prescaler, and high-linearity I and Q baseband buffers. The front-end gain-control range is over 50dB. Specifically, when the MAX2108 operates in an automatic gain control (AGC) loop, VGC is adjusted by the loop so that a sine wave at RFIN ranging in power from -70dBm to -20dBm produces a sine wave across IO_{UT}, I_{OUT} and QO_{UT}, Q_{OUT} at 10mV_{P-P} differential. The noise figure is at its minimum when GC is at its maximum gain setting.

The quadrature downconverter follows the front-end variable-gain amplifier. The mixer LO ports are fed with the two LO signals, which are 90° apart in phase. These quadrature LO signals are generated internally using the signal from the LO and L_O pins.

The resulting I/Q baseband signals are fed through separate I-channel and Q-channel baseband buffers. The outputs are capable of driving lowpass filters with 100Ω characteristic impedance (that is, the equivalent of an AC-coupled 100Ω load). The baseband -3dB output bandwidth is approximately 150MHz.

Applications Information

Front-End Tuner Circuitry for DBS Tuners

In a typical application, the signal path ahead of the tuner includes a discrete low-noise amplifier/buffer and a PIN-diode attenuator. Since the MAX2108 satisfies the noise and linearity requirements for DBS, this front-end circuitry is not required.

In some very high linearity applications, such as single channel-per-carrier (SCPC), a varactor-tuned pre-selection bandpass filter is added between a discrete LNA and the MAX2108. The filter provides a means of broadly filtering adjacent interference signals, thus improving the intermodulation performance of the tuner.

Additionally, the filter removes RF interference at twice the LO frequency, which otherwise adds to the co-channel interference. The MAX2108 rejects this carrier to approximately 25dBc.

LO Port

The MAX2108 accepts either a single-ended or differential LO signal. For single-ended drive, AC-couple the LO signal into LO with a 47pF capacitor, and bypass L_O to ground with a 47pF capacitor in series with a 25Ω resistor. Drive LO with a 50Ω source at -5dBm.

Prescaler

The prescaler requires a stable logic level at PS_SEL 4ns before the falling edge of PSOUT, PS_{OUT} to assert the desired modulus. The logic level at PS_SEL must remain static until 2ns after this falling edge.

Baseband Buffers

The MAX2108 baseband buffers provide at least 10mV_{P-P} differential swing across IO_{UT}, I_{OUT} and QO_{UT}, Q_{OUT}, and are capable of driving an AC-coupled 100Ω differential load. In a typical application, IO_{UT}, I_{OUT}, QO_{UT}, and Q_{OUT} drive a 5th- or 7th-order lowpass filter for ADC anti-aliasing purposes (see the *Filters in Direct-Conversion Tuners* section). In general, additional gain is required, after the filters. This is accomplished with a pair of video-speed op amps, such as the MAX4216 dual video op amp, or a simple transistor circuit. Contact Maxim for more information about the MAX4216.

Layout Considerations

Observe standard RF layout rules. A ground plane is essential; when connecting areas of ground plane between layers, use vias liberally. If a ground plane is used under the lowpass filters, note that the filter response may be slightly offset due to parasitic capacitance.

In a direct-conversion receiver, LO leakage to the RF input connector is a major issue, since filtering of the LO is impossible (the LO operates at the same frequency as the RF input). Observe the power-supply bypass capacitor connections in the *Pin Description* table, notably pins 3, 5, 12, and 21. Traces from these IC pins to the bypass capacitors must be kept on the top side of the board and as short as possible.

Direct-Conversion Tuner IC

Power-Supply Sequencing

The MAX2108 has several +5V supply pins. Configure the supply layout in a star format, with a bypass capacitor that dominates the rise time of the supply at the center of the star to ensure that all pins see approximately the same voltage during power-up.

Filters in Direct-Conversion Tuners

Typically, a 5th- or 7th-order L-C lowpass filter is used for anti-aliasing the ADCs following the MAX2108. Table 1 offers suggested component values for these lowpass filters. Figures 1 and 2 describe typical filtering requirements.

Table 1. Suggested Component Values for Discrete Lowpass Filters

ADC SAMPLING RATE (MSPS)	FILTER TYPE	R _S (Ω)	C1 (pF)	L1 (nH)	C2 (pF)	L2 (nH)	C3 (pF)	L3 (nH)	C4 (pF)	R _L (kΩ)
40	0.1dB Chebyshev, f _C = 20MHz	50	20	910	60	1500	75	1500	60	20
60	0.1dB Chebyshev, f _C = 30MHz	50	11	620	41	910	50	1000	41	20
90	0.1dB Chebyshev, f _C = 20MHz	50	15	680	39	820	33	Short	Open	20
	0.1dB Chebyshev, f _C = 45MHz	50	9	390	28	620	34	680	28	20

Direct-Conversion Tuner IC

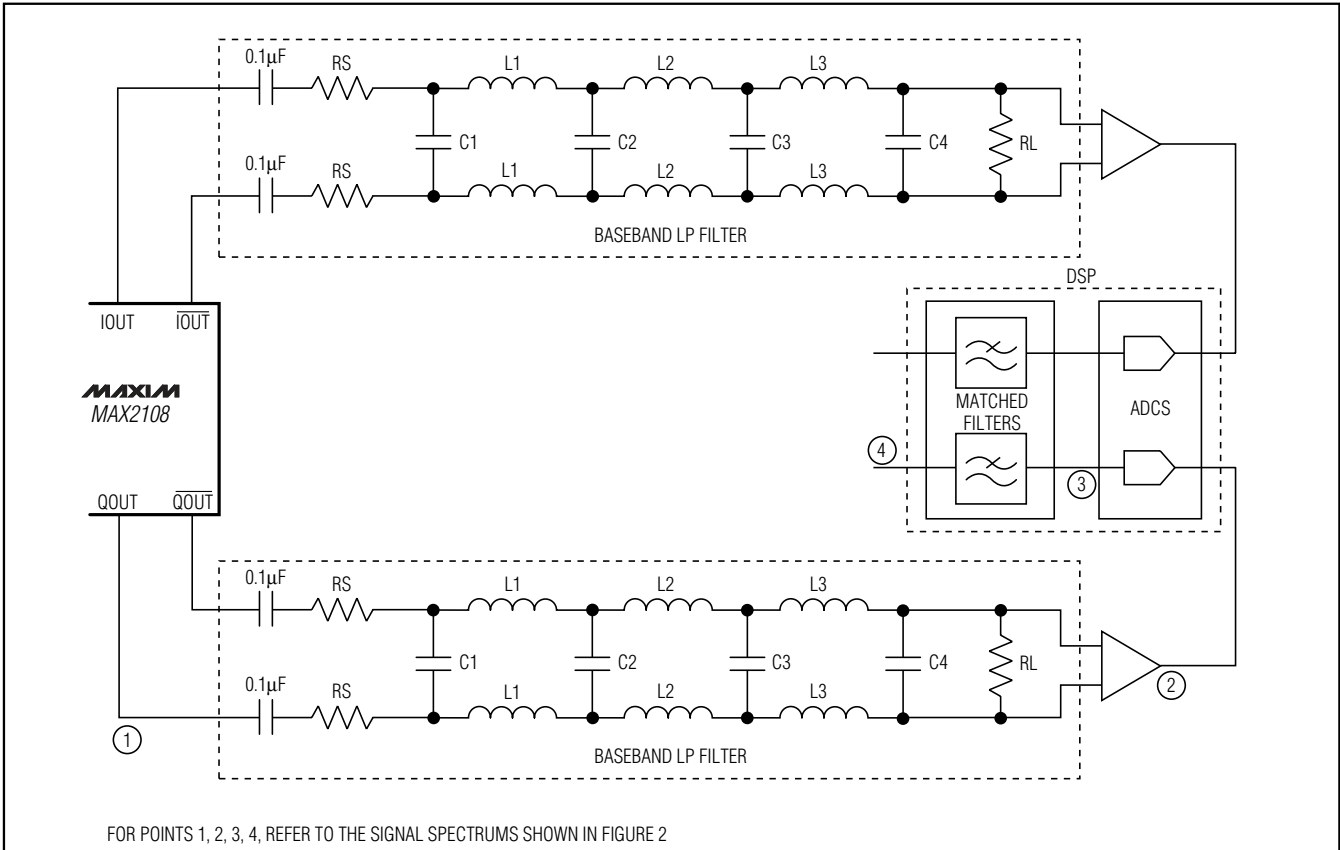

Figure 1. In-Phase and Quadrature-Phase Signal Paths

Direct-Conversion Tuner IC

MAX2108

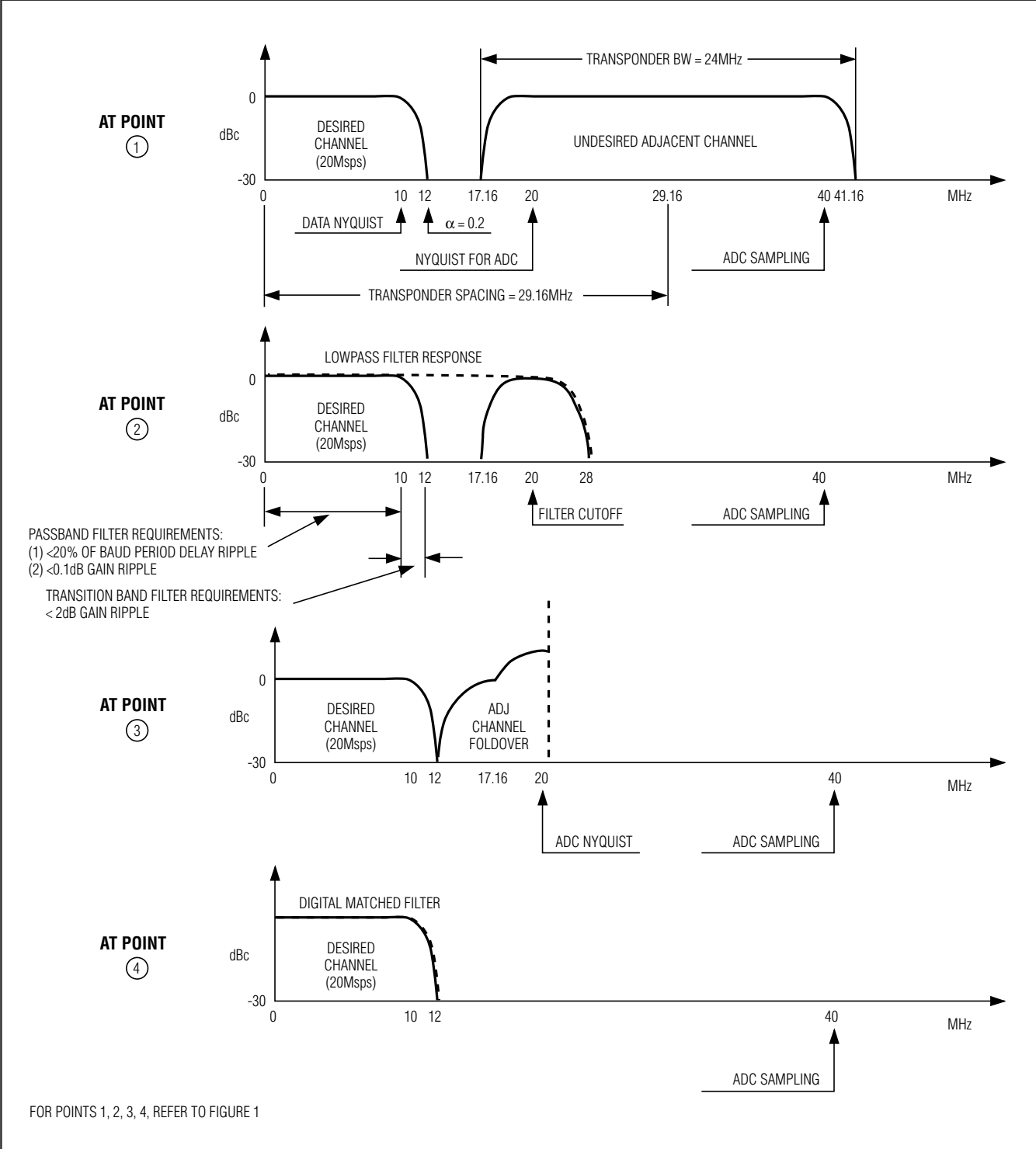
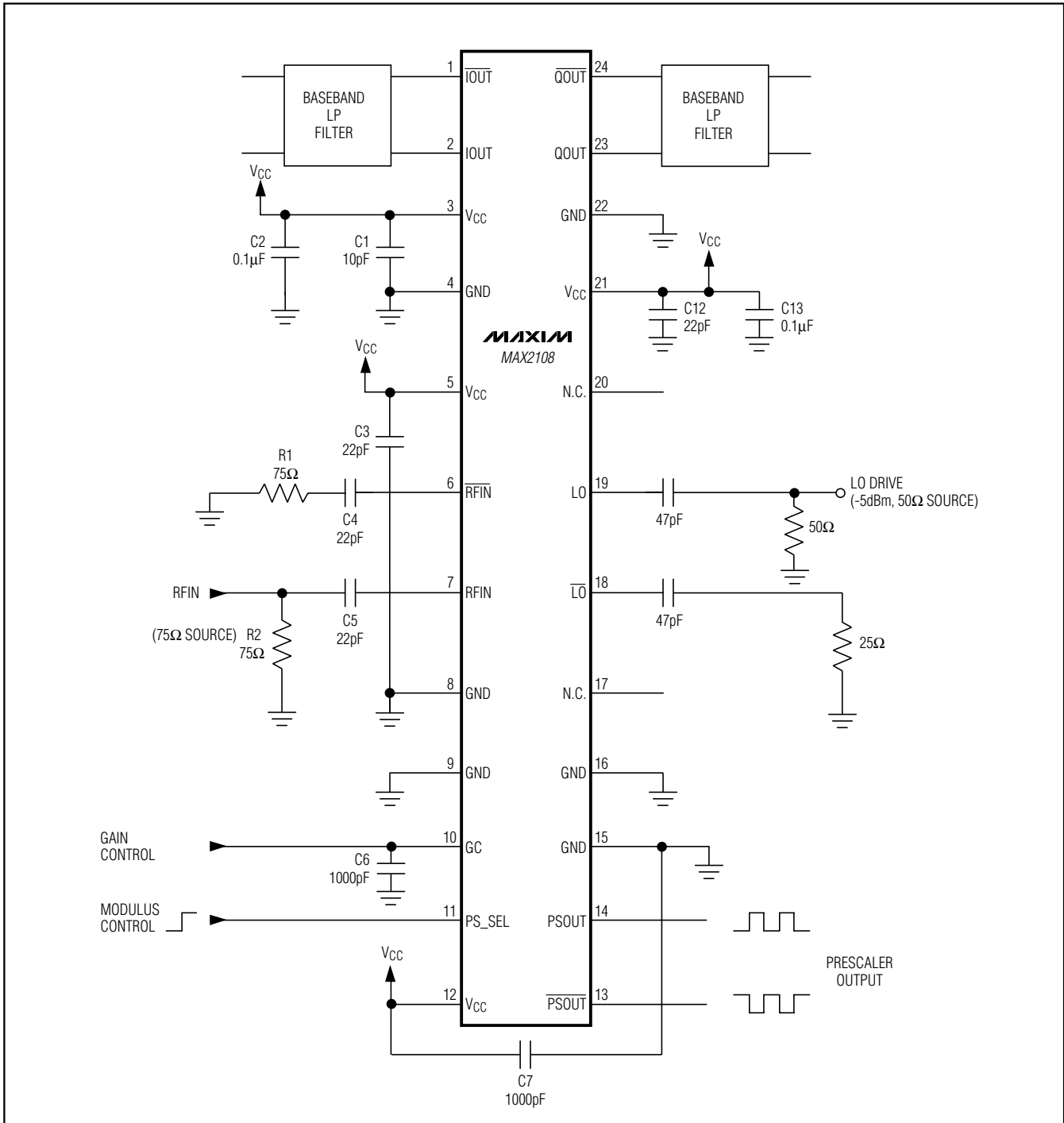

Figure 2. Lowpass Filtering Example

Direct-Conversion Tuner IC

Typical Operating Circuit



Direct-Conversion Tuner IC

MAX2108

Pin Configuration

Chip Information

TRANSISTOR COUNT: 1484

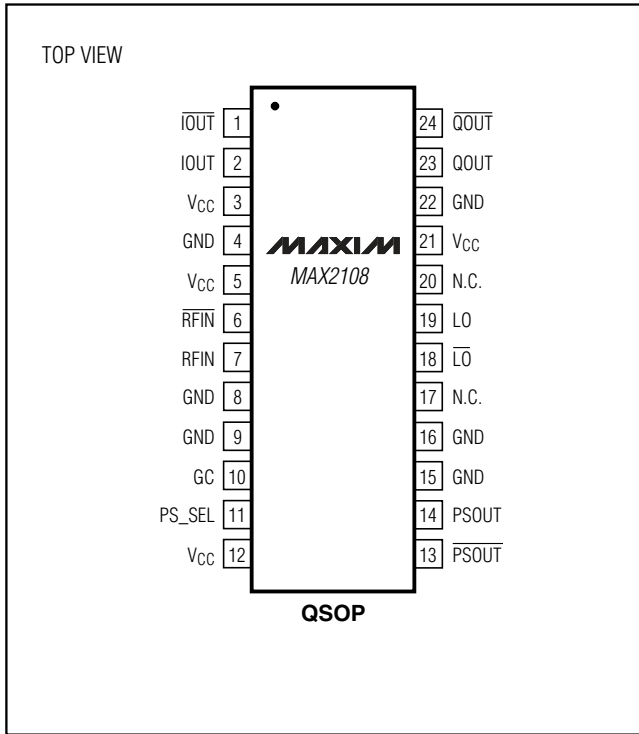

Direct-Conversion Tuner IC

Package Information

(The package drawing(s) in this data sheet may not reflect the most current specifications. For the latest package outline information, go to www.maxim-ic.com/packages.)

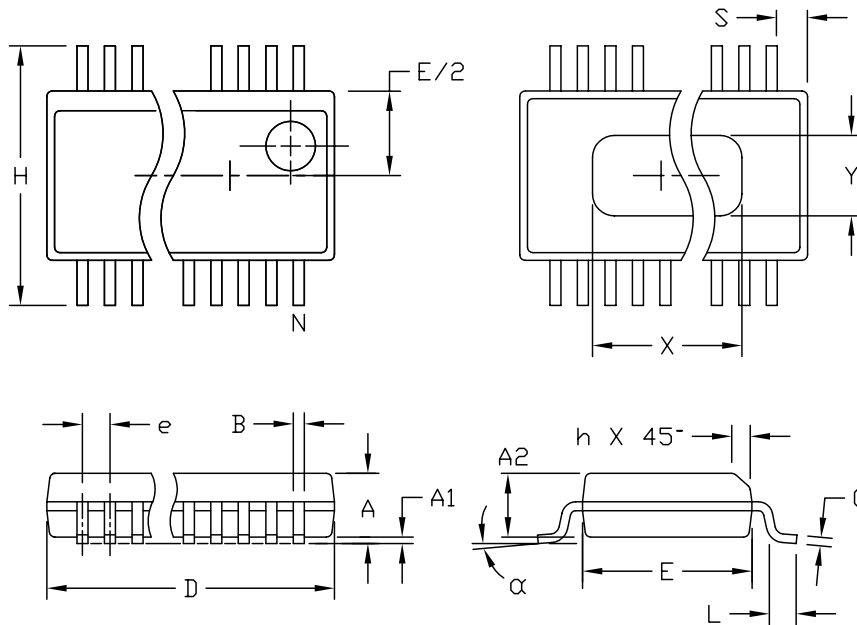

DIM	INCHES		MILLIMETERS	
	MIN	MAX	MIN	MAX
A	.061	.068	1.55	1.73
A1	.004	.0098	0.102	0.249
A2	.055	.061	1.40	1.55
B	.008	.012	0.20	0.31
C	.0075	.0098	0.191	0.249
D	SEE VARIATIONS			
E	.150	.157	3.81	3.99
e	.025 BSC		0.635 BSC	
H	.230	.244	5.84	6.20
h	.010	.016	0.25	0.41
L	.016	.035	0.41	0.89
N	SEE VARIATIONS			
X	SEE VARIATIONS			
Y	.071	.087	1.803	2.209
α	0°	8°	0°	8°

VARIATIONS:

DIM	INCHES		MILLIMETERS		N
	MIN.	MAX.	MIN.	MAX.	
D	.189	.196	4.80	4.98	16 AA
S	.0020	.0070	0.05	0.18	
X	.107	.123	2.72	3.12	
D	.337	.344	8.56	8.74	20 AB
S	.0500	.0550	1.270	1.397	
D	.337	.344	8.56	8.74	24 AC
S	.0250	.0300	0.635	0.762	
D	.386	.393	9.80	9.98	28 AD
S	.0250	.0300	0.635	0.762	
X	.271	.287	6.88	7.29	

NOTES:

1. D & E DO NOT INCLUDE MOLD FLASH OR PROTRUSIONS.
2. MOLD FLASH OR PROTRUSIONS NOT TO EXCEED .006" PER SIDE.
3. HEAT SLUG DIMENSIONS X AND Y APPLY ONLY TO 16 AND 28 LEAD POWER-QSDP PACKAGES.
4. CONTROLLING DIMENSIONS: INCHES.
5. MEETS JEDEC MO137.

MAXIM

PROPRIETARY INFORMATION

TITLE:
PACKAGE OUTLINE, QSDP, .150", .025" LEAD PITCH

APPROVAL	DOCUMENT CONTROL NO.	REV	1/1
	21-0055	C	

QSDP-EPS

Maxim cannot assume responsibility for use of any circuitry other than circuitry entirely embodied in a Maxim product. No circuit patent licenses are implied. Maxim reserves the right to change the circuitry and specifications without notice at any time.

12 **Maxim Integrated Products, 120 San Gabriel Drive, Sunnyvale, CA 94086 408-737-7600**