

### General Description

- Trench Power AlphaSGT™ technology
- Low  $R_{DS(ON)}$
- Logic Level Gate Drive
- ESD Protected
- Excellent Gate Charge x  $R_{DS(ON)}$  Product (FOM)
- RoHS and Halogen-Free Compliant

### Applications

- High Frequency Switching and Synchronous Rectification

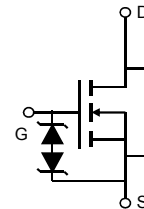
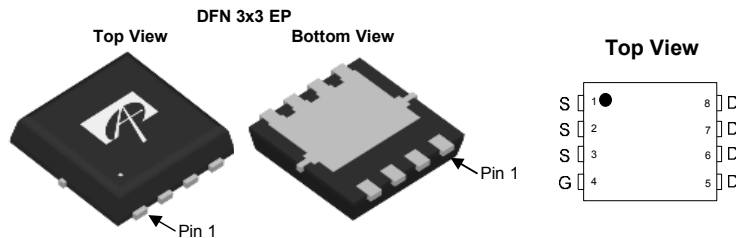
### Product Summary

$V_{DS}$	60V
$I_D$ (at $V_{GS}=10V$ )	24A
$R_{DS(ON)}$ (at $V_{GS}=10V$ )	< 13.2m $\Omega$
$R_{DS(ON)}$ (at $V_{GS}=4.5V$ )	< 17.7m $\Omega$

### Typical ESD protection

100% UIS Tested  
100% Rg Tested

### HBM Class 2



Orderable Part Number	Package Type	Form	Minimum Order Quantity
AON7246E	DFN 3x3 EP	Tape & Reel	5000

### Absolute Maximum Ratings $T_A=25^\circ\text{C}$ unless otherwise noted

Parameter	Symbol	Maximum	Units	
Drain-Source Voltage	$V_{DS}$	60	V	
Gate-Source Voltage	$V_{GS}$	$\pm 20$	V	
Continuous Drain Current <sup>G</sup>	$T_C=25^\circ\text{C}$	24	A	
	$T_C=100^\circ\text{C}$	20		
Pulsed Drain Current <sup>C</sup>	$I_{DM}$	90		
Continuous Drain Current	$T_A=25^\circ\text{C}$	13	A	
	$T_A=70^\circ\text{C}$	10		
Avalanche Current <sup>C</sup>	$I_{AS}$	14	A	
Avalanche energy $L=0.3\text{mH}$ <sup>C</sup>	$E_{AS}$	29	mJ	
$V_{DS}$ Spike <sup>I</sup>	10 $\mu\text{s}$	$V_{SPIKE}$	72	V
Power Dissipation <sup>B</sup>	$T_C=25^\circ\text{C}$	24	W	
	$T_C=100^\circ\text{C}$	9.5		
Power Dissipation <sup>A</sup>	$T_A=25^\circ\text{C}$	4.1	W	
	$T_A=70^\circ\text{C}$	2.6		
Junction and Storage Temperature Range	$T_J, T_{STG}$	-55 to 150	$^\circ\text{C}$	

### Thermal Characteristics

Parameter	Symbol	Typ	Max	Units
Maximum Junction-to-Ambient <sup>A</sup> $t \leq 10\text{s}$	$R_{\theta JA}$	24	30	$^\circ\text{C/W}$
Maximum Junction-to-Ambient <sup>A,D</sup> Steady-State		45	55	$^\circ\text{C/W}$
Maximum Junction-to-Case Steady-State	$R_{\theta JC}$	4.2	5.2	$^\circ\text{C/W}$

**Electrical Characteristics (T<sub>J</sub>=25°C unless otherwise noted)**

Symbol	Parameter	Conditions	Min	Typ	Max	Units
<b>STATIC PARAMETERS</b>						
BV <sub>DSS</sub>	Drain-Source Breakdown Voltage	I <sub>D</sub> =250μA, V <sub>GS</sub> =0V	60			V
I <sub>DSS</sub>	Zero Gate Voltage Drain Current	V <sub>DS</sub> =60V, V <sub>GS</sub> =0V T <sub>J</sub> =55°C			1 5	μA
I <sub>GSS</sub>	Gate-Body leakage current	V <sub>DS</sub> =0V, V <sub>GS</sub> =±20V			±10	μA
V <sub>GS(th)</sub>	Gate Threshold Voltage	V <sub>DS</sub> =V <sub>GS</sub> , I <sub>D</sub> =250μA	1.2	1.7	2.2	V
R <sub>DS(on)</sub>	Static Drain-Source On-Resistance	V <sub>GS</sub> =10V, I <sub>D</sub> =13A T <sub>J</sub> =125°C		10.7	13.2	mΩ
		V <sub>GS</sub> =4.5V, I <sub>D</sub> =11A		17.4	21.3	
g <sub>FS</sub>	Forward Transconductance	V <sub>DS</sub> =5V, I <sub>D</sub> =13A		38		S
V <sub>SD</sub>	Diode Forward Voltage	I <sub>S</sub> =1A, V <sub>GS</sub> =0V		0.72	1	V
I <sub>S</sub>	Maximum Body-Diode Continuous Current <sup>G</sup>				24	A
<b>DYNAMIC PARAMETERS</b>						
C <sub>iss</sub>	Input Capacitance	V <sub>GS</sub> =0V, V <sub>DS</sub> =30V, f=1MHz		755		pF
C <sub>oss</sub>	Output Capacitance			220		pF
C <sub>rss</sub>	Reverse Transfer Capacitance			20		pF
R <sub>g</sub>	Gate resistance	f=1MHz	0.6	1.3	2.0	Ω
<b>SWITCHING PARAMETERS</b>						
Q <sub>g(10V)</sub>	Total Gate Charge	V <sub>GS</sub> =10V, V <sub>DS</sub> =30V, I <sub>D</sub> =13A		13.5	20	nC
Q <sub>g(4.5V)</sub>	Total Gate Charge			6.5	10	nC
Q <sub>gs</sub>	Gate Source Charge			2.5		nC
Q <sub>gd</sub>	Gate Drain Charge			3.0		nC
Q <sub>oss</sub>	Output Charge	V <sub>GS</sub> =0V, V <sub>DS</sub> =30V		11		nC
t <sub>D(on)</sub>	Turn-On DelayTime	V <sub>GS</sub> =10V, V <sub>DS</sub> =30V, R <sub>L</sub> =2.3Ω, R <sub>GEN</sub> =3Ω		5		ns
t <sub>r</sub>	Turn-On Rise Time			3		ns
t <sub>D(off)</sub>	Turn-Off DelayTime			19		ns
t <sub>f</sub>	Turn-Off Fall Time			3		ns
t <sub>rr</sub>	Body Diode Reverse Recovery Time	I <sub>F</sub> =13A, di/dt=500A/μs		15		ns
Q <sub>rr</sub>	Body Diode Reverse Recovery Charge	I <sub>F</sub> =13A, di/dt=500A/μs		49		nC

A. The value of R<sub>θJA</sub> is measured with the device mounted on 1in<sup>2</sup> FR-4 board with 2oz. Copper, in a still air environment with T<sub>A</sub> =25° C. The Power dissipation P<sub>DSM</sub> is based on R<sub>θJA</sub> ≤ 10s and the maximum allowed junction temperature of 150° C. The value in any given application depends on the user's specific board design.

B. The power dissipation P<sub>D</sub> is based on T<sub>J(MAX)</sub>=150° C, using junction-to-case thermal resistance, and is more useful in setting the upper dissipation limit for cases where additional heatsinking is used.

C. Single pulse width limited by junction temperature T<sub>J(MAX)</sub>=150° C.

D. The R<sub>θJA</sub> is the sum of the thermal impedance from junction to case R<sub>θJC</sub> and case to ambient.

E. The static characteristics in Figures 1 to 6 are obtained using <300μs pulses, duty cycle 0.5% max.

F. These curves are based on the junction-to-case thermal impedance which is measured with the device mounted to a large heatsink, assuming a maximum junction temperature of T<sub>J(MAX)</sub>=150° C. The SOA curve provides a single pulse rating.

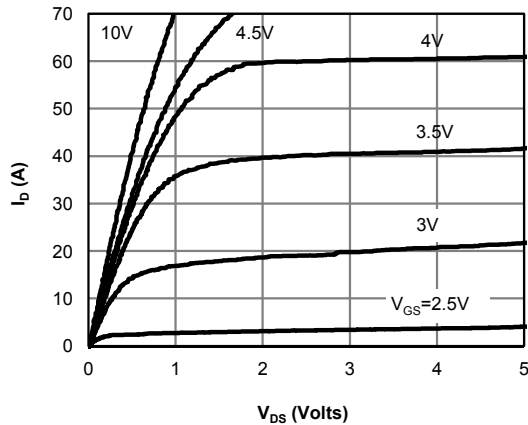
G. The maximum current rating is package limited.

H. These tests are performed with the device mounted on 1 in<sup>2</sup> FR-4 board with 2oz. Copper, in a still air environment with T<sub>A</sub>=25° C.

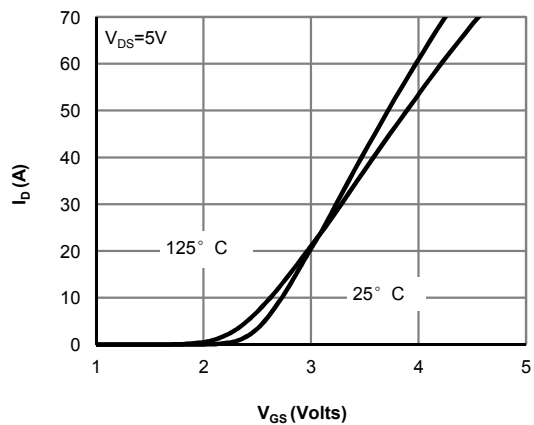
I. The spike duty cycle 5% max, limited by junction temperature T<sub>J(MAX)</sub>=125° C.

APPLICATIONS OR USE AS CRITICAL COMPONENTS IN LIFE SUPPORT DEVICES OR SYSTEMS ARE NOT AUTHORIZED. AOS DOES NOT ASSUME ANY LIABILITY ARISING OUT OF SUCH APPLICATIONS OR USES OF ITS PRODUCTS. AOS RESERVES THE RIGHT TO IMPROVE PRODUCT DESIGN,FUNCTIONS AND RELIABILITY WITHOUT NOTICE.

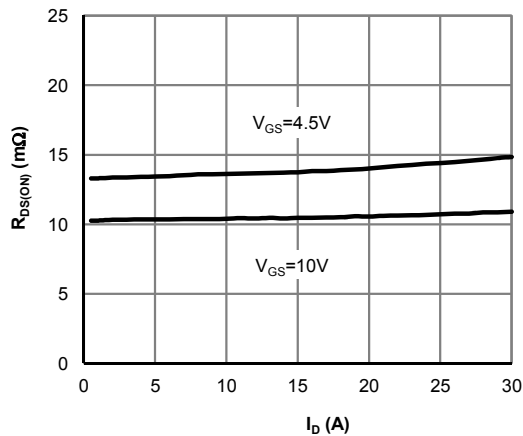
**TYPICAL ELECTRICAL AND THERMAL CHARACTERISTICS**



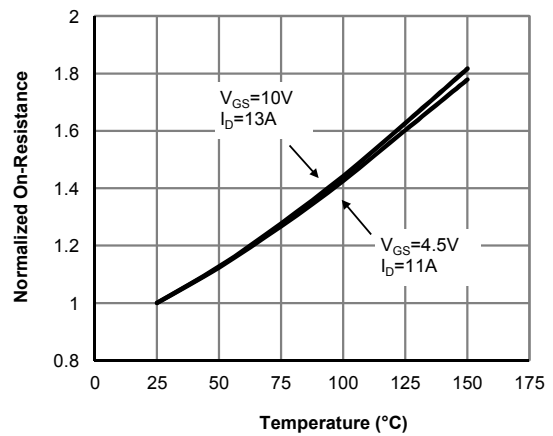
**Figure 1: On-Region Characteristics (Note E)**



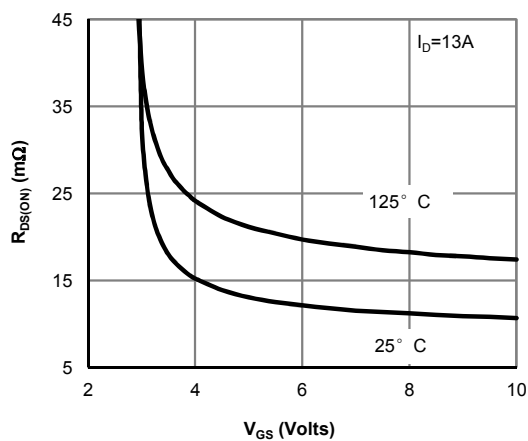
**Figure 2: Transfer Characteristics (Note E)**



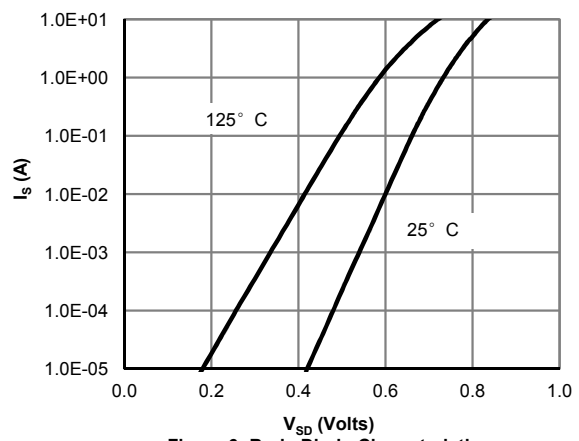
**Figure 3: On-Resistance vs. Drain Current and Gate Voltage (Note E)**



**Figure 4: On-Resistance vs. Junction Temperature (Note E)**

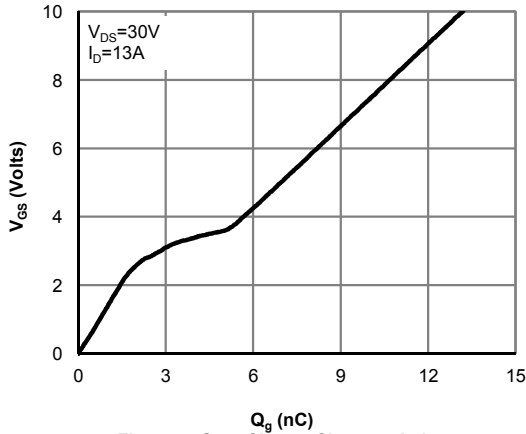


**Figure 5: On-Resistance vs. Gate-Source Voltage (Note E)**

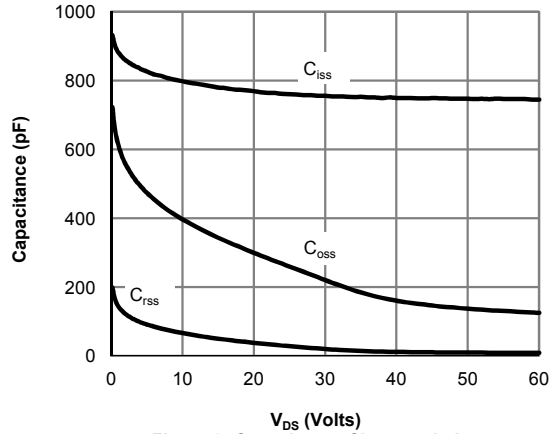


**Figure 6: Body-Diode Characteristics (Note E)**

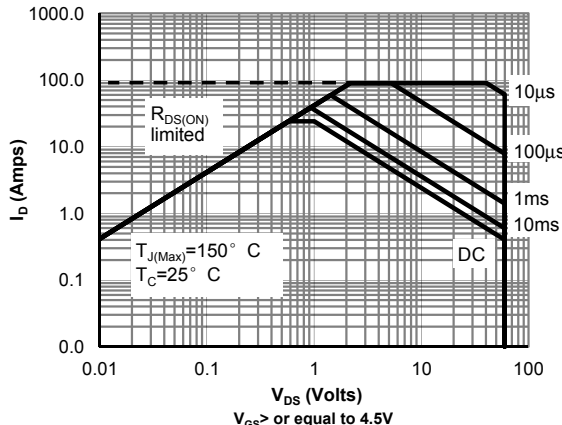
**TYPICAL ELECTRICAL AND THERMAL CHARACTERISTICS**



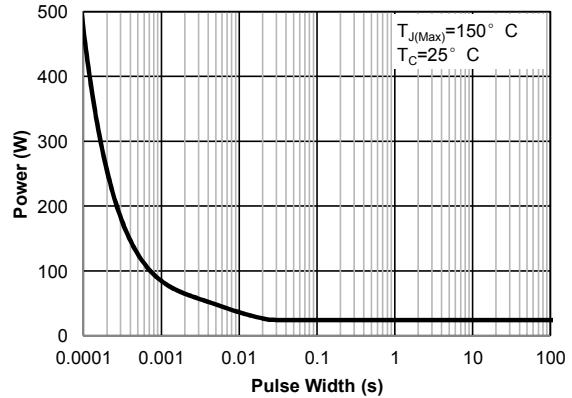
**Figure 7: Gate-Charge Characteristics**



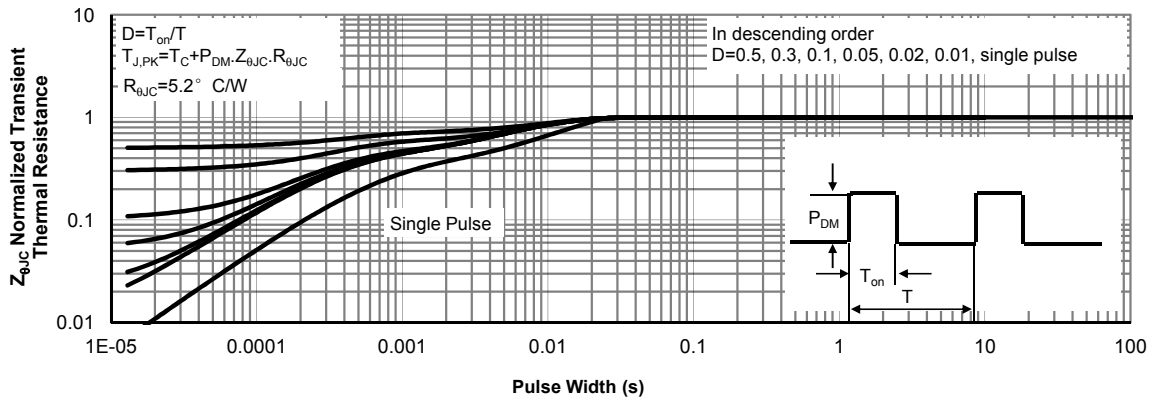
**Figure 8: Capacitance Characteristics**



**Figure 9: Maximum Forward Biased Safe Operating Area (Note F)**



**Figure 10: Single Pulse Power Rating Junction-to-Case (Note F)**



**Figure 11: Normalized Maximum Transient Thermal Impedance (Note F)**

**TYPICAL ELECTRICAL AND THERMAL CHARACTERISTICS**

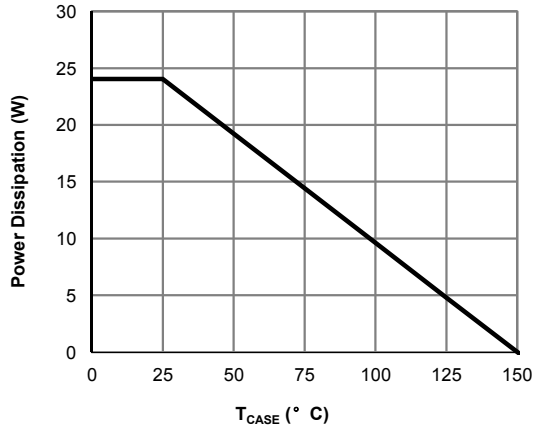


Figure 12: Power De-rating (Note F)

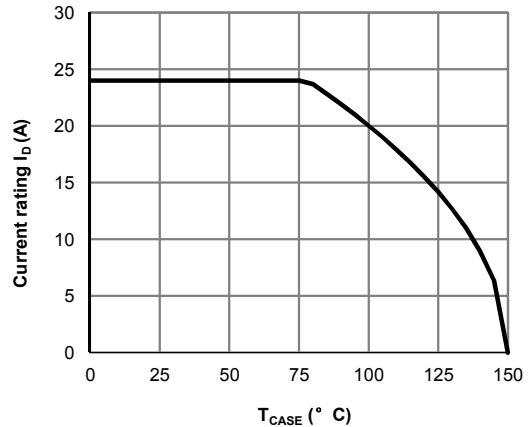


Figure 13: Current De-rating (Note F)

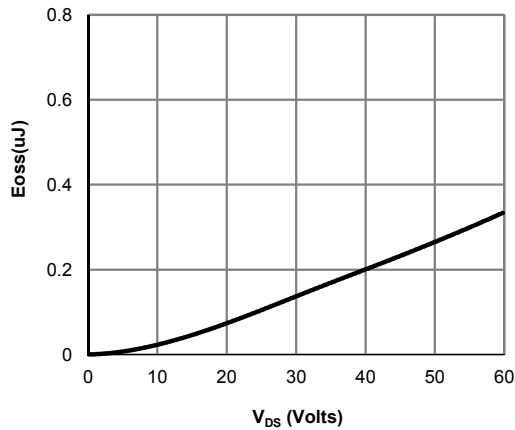


Figure 14: Coss stored Energy

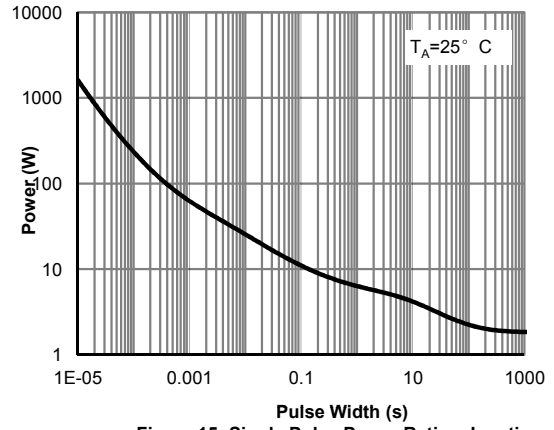


Figure 15: Single Pulse Power Rating Junction-to-Ambient (Note H)

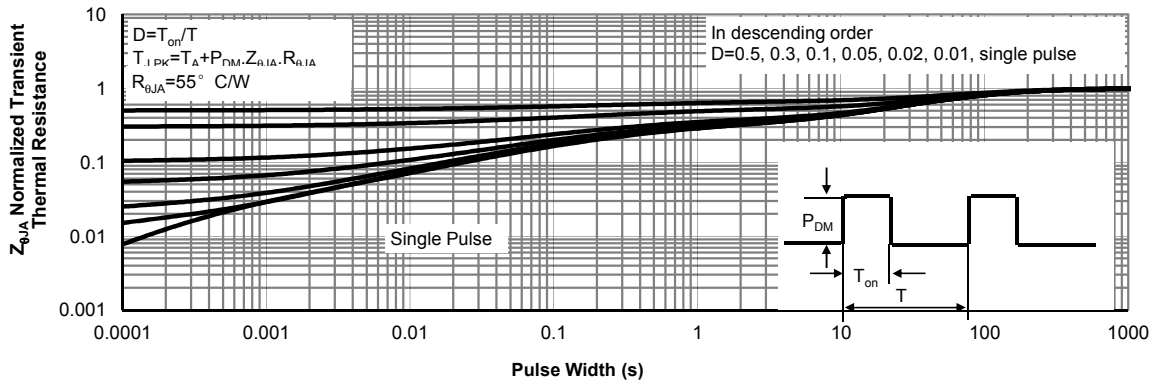


Figure 16: Normalized Maximum Transient Thermal Impedance (Note H)

Figure A: Gate Charge Test Circuit & Waveforms

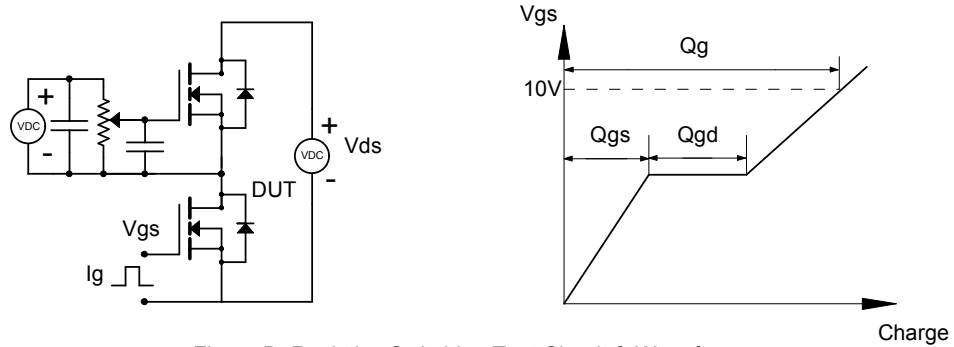


Figure B: Resistive Switching Test Circuit & Waveforms

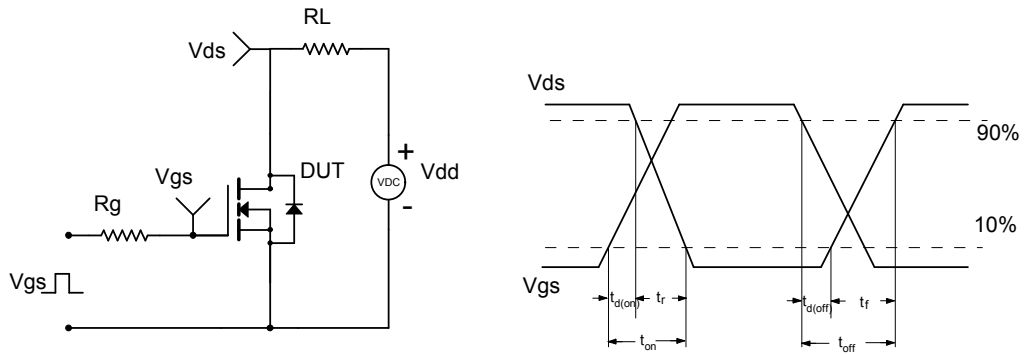


Figure C: Unclamped Inductive Switching (UIS) Test Circuit & Waveforms

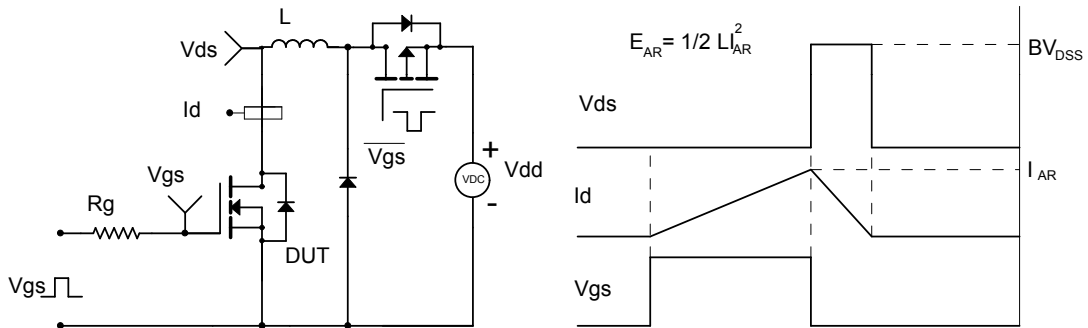


Figure D: Diode Recovery Test Circuit & Waveforms

