

# PB Series Single Pole and Multi-Key Pushbutton Switches



A  
Pushbutton

## Features/Benefits

- Momentary or latching options
- Reliable contact design
- 2, 4, and 6 pole configurations
- Long travel and extended life cycles

## Typical Applications

- Appliances
- Audio and visual equipment
- Consumer electronics
- Industrial equipment



## Specifications

CONTACT RATING: 0.3A @ 30 VDC  
 INITIAL CONTACT RESISTANCE: 30 m ohms max.  
 INSULATION RESISTANCE: 100 M ohms min.  
 DIELECTRIC STRENGTH: 500 V AC (50-60 Hz) between open terminals and between the frame and terminal.  
 OPERATING LIFE: 10,000 cycles without load  
 OPERATING FORCE:  
     250 ± 100 gf (2.45 ± 0.98N)  
 LOCK TRAVEL: 2 ± 0.3 mm  
 TOTAL TRAVEL: 3 ± 0.3 mm  
 OPERATING TEMPERATURE: -20°C to 70°C

## Materials

CASE: PC (UL 94HB)  
 PLASTIC CLIP: POM (UL 94HB)  
 SPRING: SUS  
 KNOB: POM  
 TERMINAL: Silver plated

## PB-22D01-L 2PDT LOCK / LATCHING

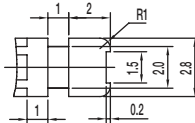
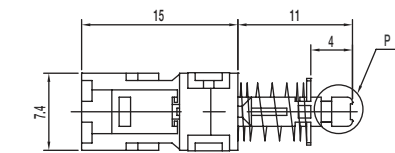

P DETAIL 2:1

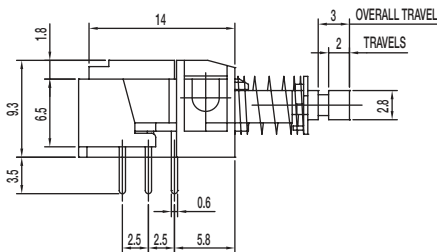

2P — 2T

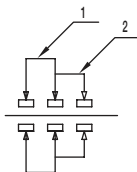
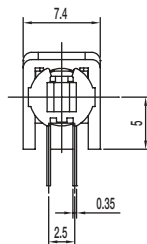

SCHEMATIC

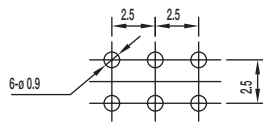

PIERCING PLAN



# PB Series Single Pole and Multi-Key Pushbutton Switches

Pushbutton

A

## PB-42D01-L 4PDT LOCK / LATCHING

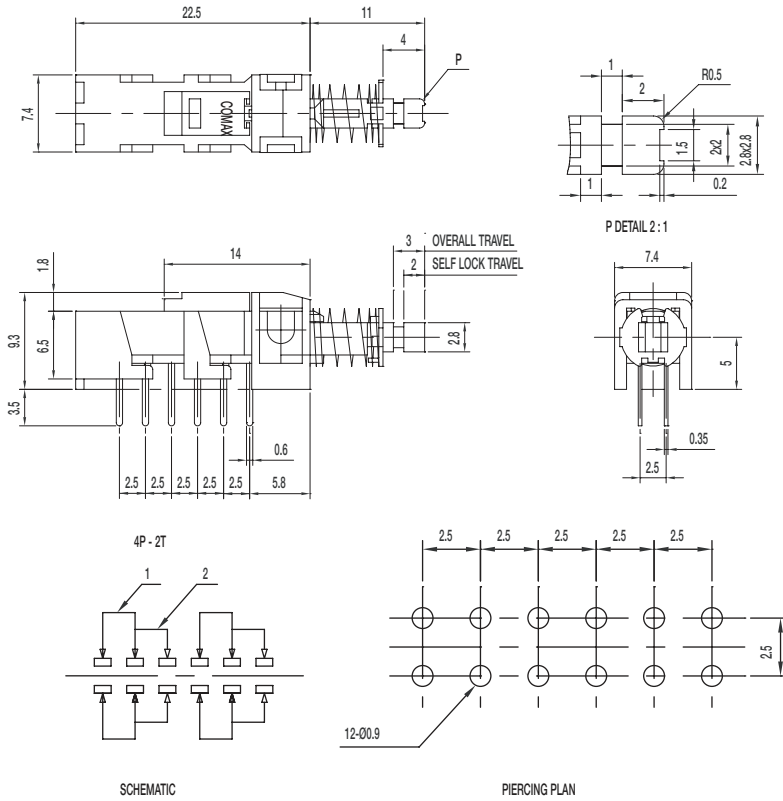

### Specifications

- CONTACT RATING: 0.3A @ 30 VDC
- INITIAL CONTACT RESISTANCE: 30 m ohms max.
- INSULATION RESISTANCE: 100 M ohms min.
- DIELECTRIC STRENGTH: 500 V AC (50-60 Hz) between open terminals and between the frame and terminal.
- OPERATING LIFE: 10,000 cycles without load
- OPERATING FORCE:  
280 ± 100 gf
- LOCK TRAVEL: 2 ± 0.3 mm
- TOTAL TRAVEL: 3 ± 0.3 mm
- OPERATING TEMPERATURE: -20°C to 70°C

### Materials

- CASE: PC (UL 94HB)
- PLASTIC CLIP: POM (UL 94HB)
- SPRING: SUS
- KNOB: POM
- TERMINAL: Silver plated

## PB-62D01-L 6PDT LOCK / LATCHING

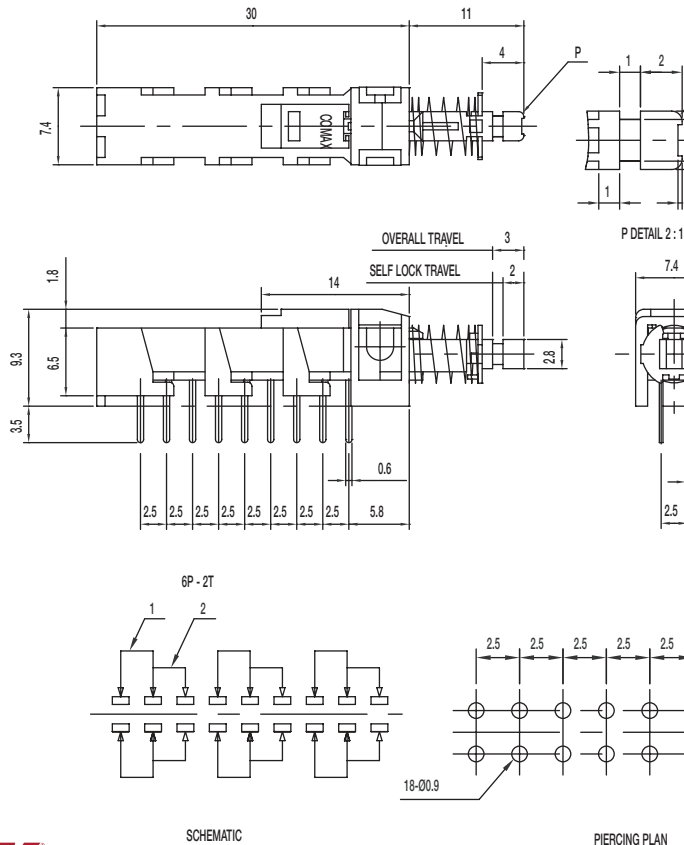

### Specifications

- CONTACT RATING: 0.3A @ 30 VDC
- INITIAL CONTACT RESISTANCE: 30 m ohms max.
- INSULATION RESISTANCE: 100 M ohms min.
- DIELECTRIC STRENGTH: 500 V AC (50-60 Hz) between open terminals and between the frame and terminal.
- OPERATING LIFE: 10,000 cycles without load
- OPERATING FORCE:  
300 ± 100 gf (2.94 ± 0.98N)
- LOCK TRAVEL: 2 ± 0.3 mm
- TOTAL TRAVEL: 3 ± 0.3 mm
- OPERATING TEMPERATURE: -20°C to 70°C

### Materials

- CASE: PC (UL 94HB)
- PLASTIC CLIP: POM (UL 94HB)
- SPRING: SUS
- KNOB: POM
- TERMINAL: Silver plated



*Dimensions are shown: mm  
Specifications and dimensions subject to change*

# PB Series Single Pole and Multi-Key Pushbutton Switches



A  
Pushbutton

## PB-22D01-F 2PDT NON-LOCK / MOMENTARY

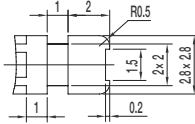
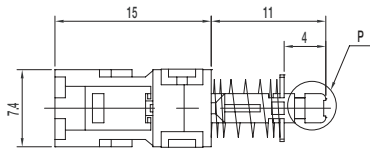

P DETAIL 2:1

### Specifications

- CONTACT RATING: 0.3A @ 30 VDC
- INITIAL CONTACT RESISTANCE: 30 m ohms max.
- INSULATION RESISTANCE: 100 M ohms min.
- DIELECTRIC STRENGTH: 500 V AC (50-60 Hz) between open terminals and between the frame and terminal.
- OPERATING LIFE: 10,000 cycles without load
- OPERATING FORCE:  
250 ± 100 gf (2.45 ± 0.98N)
- TOTAL TRAVEL: 3 ± 0.3 mm
- OPERATING TEMPERATURE: -20°C to 70°C

### Materials

- CASE: PC (UL 94HB)
- PLASTIC CLIP: POM (UL 94HB)
- SPRING: SUS
- KNOB: POM
- TERMINAL: Silver plated

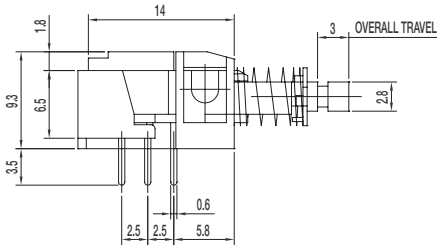

2P - 2T

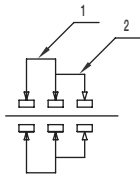
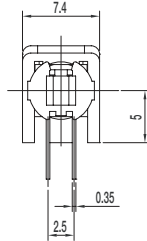

SCHEMATIC

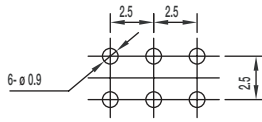

PIERCING PLAN

## PB-42D01-F 4PDT NON-LOCK / MOMENTARY

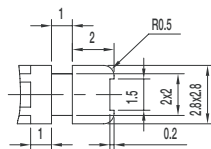
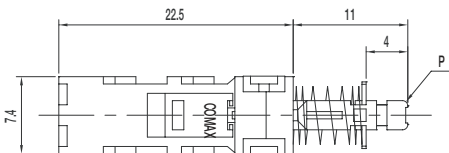

P DETAIL 2:1

### Specifications

- CONTACT RATING: 0.3A @ 30 VDC
- INITIAL CONTACT RESISTANCE: 30 m ohms max.
- INSULATION RESISTANCE: 100 M ohms min.
- DIELECTRIC STRENGTH: 500 V AC (50-60 Hz) between open terminals and between the frame and terminal.
- OPERATING LIFE: 10,000 cycles without load
- OPERATING FORCE:  
280 ± 100 gf (2.477 ± 0.98N)
- TOTAL TRAVEL: 3 ± 0.3 mm
- OPERATING TEMPERATURE: -20°C to 70°C

### Materials

- CASE: PC (UL 94HB)
- PLASTIC CLIP: POM (UL 94HB)
- SPRING: SUS
- KNOB: POM
- TERMINAL: Silver plated

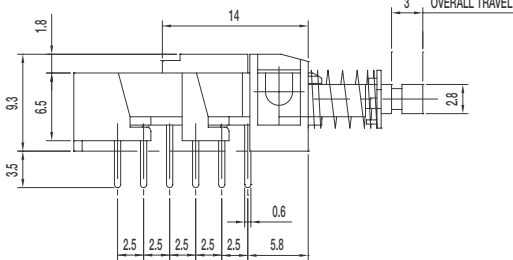

4P - 2T

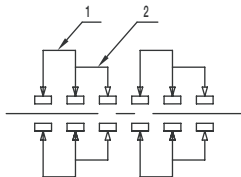
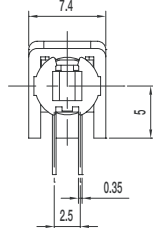

SCHEMATIC

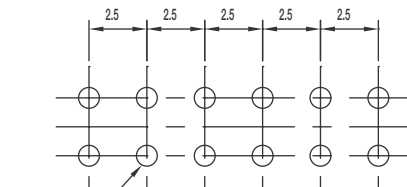

PIERCING PLAN



Dimensions are shown: mm  
Specifications and dimensions subject to change



# PB Series Single Pole and Multi-Key Pushbutton Switches

Pushbutton  
A

## PB-62D01-F 6PDT NON-LOCK / MOMENTARY

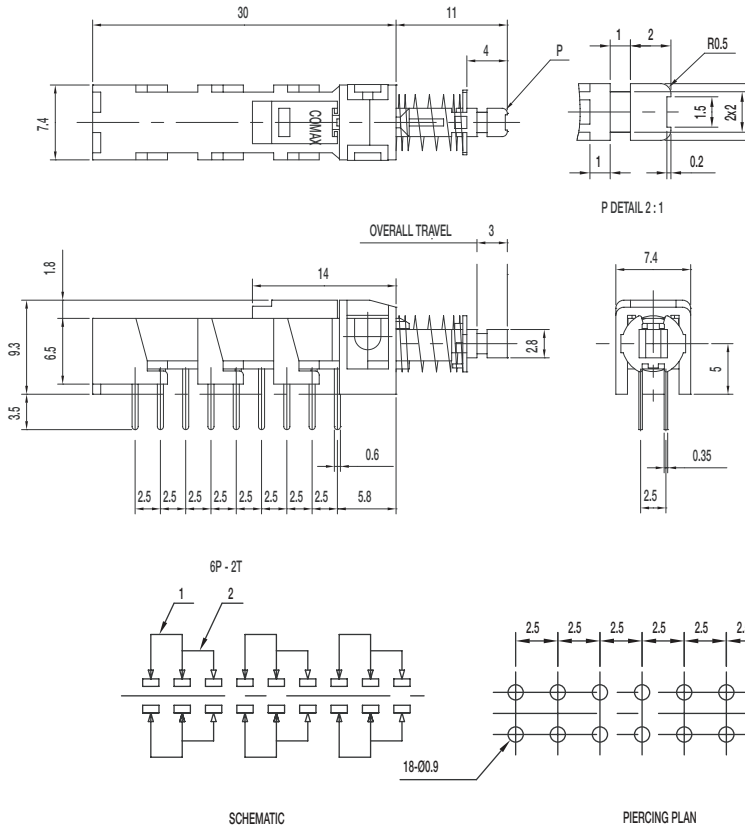

### Specifications

- CONTACT RATING: 0.3A @ 30 VDC
- INITIAL CONTACT RESISTANCE: 30 m ohms max.
- INSULATION RESISTANCE: 100 M ohms min.
- DIELECTRIC STRENGTH: 500 V AC (50-60 Hz) between open terminals and between the frame and terminal.
- OPERATING LIFE: 10,000 cycles without load
- OPERATING FORCE: 300 ± 100 gf (2.94 ± 0.98N)
- TOTAL TRAVEL: 3 ± 0.3 mm
- OPERATING TEMPERATURE: -20°C to 70°C

### Materials

- CASE: PC (UL 94HB)
- PLASTIC CLIP: POM (UL 94HB)
- SPRING: SUS
- KNOB: POM
- TERMINAL: Silver plated

## PB-22G02-L 2PDT LOCK / LATCHING

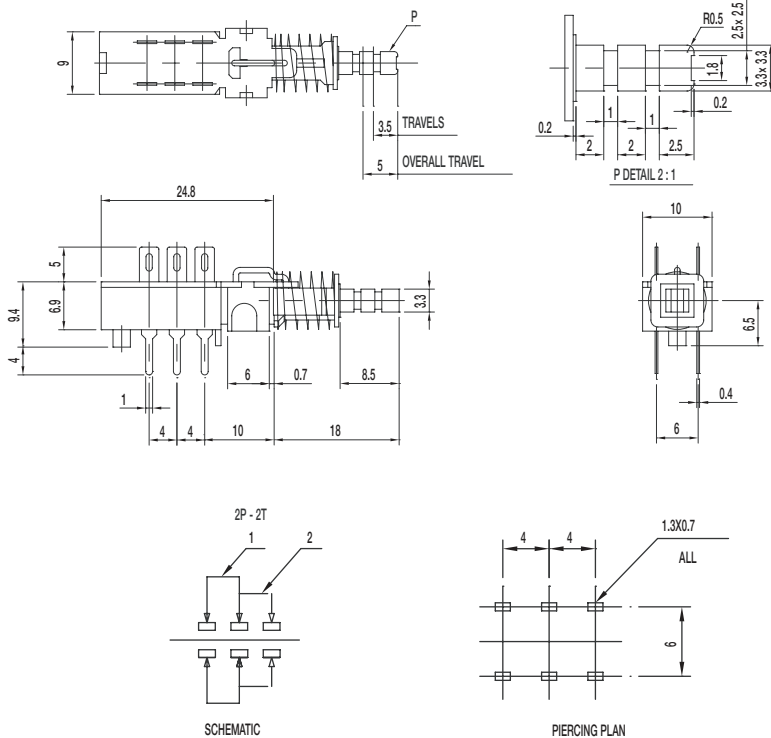

### Specifications

- CONTACT RATING: 1A @ 25 VDC
- INITIAL CONTACT RESISTANCE: 30 m ohms max.
- INSULATION RESISTANCE: 100 M ohms min.
- DIELECTRIC STRENGTH: 500 V AC (50-60 Hz) between open terminals and between the frame and terminal.
- OPERATING LIFE: 10,000 cycles without load
- OPERATING FORCE: 350 ± 150 gf (3.43 ± 1.47N)
- LOCK TRAVEL: 3.5 ± 0.3mm
- TOTAL TRAVEL: 5 ± 0.3 mm
- OPERATING TEMPERATURE: -20°C to 70°C

### Materials

- CASE: PC (UL 94HB)
- SPRING: SUS
- KNOB: POM
- TERMINAL: Silver plated



Dimensions are shown: mm  
Specifications and dimensions subject to change

# PB Series Single Pole and Multi-Key Pushbutton Switches



A

Pushbutton

## PB-42G02-L 4PDT LOCK / LATCHING

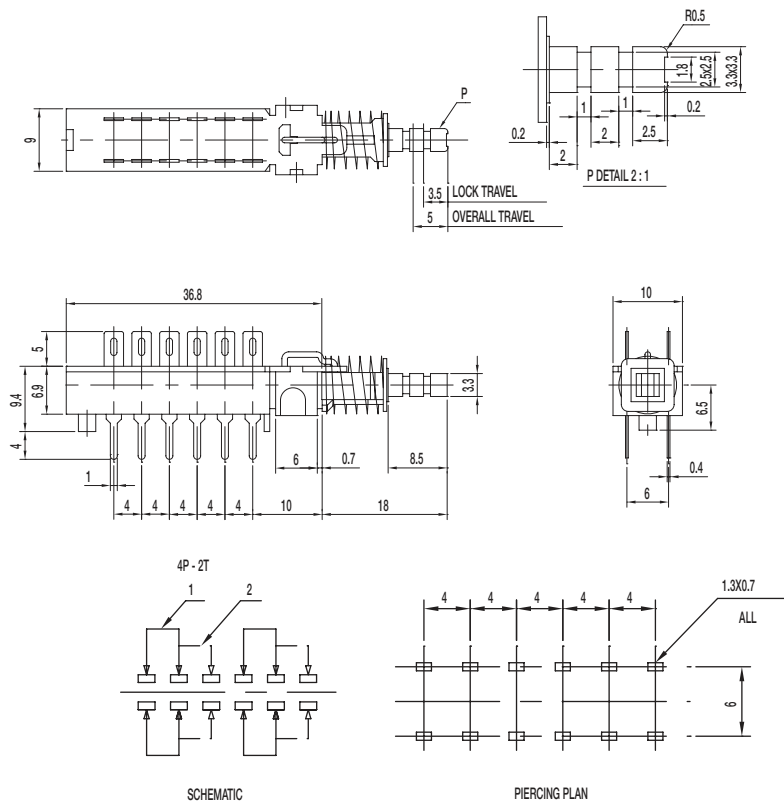

### Specifications

- CONTACT RATING: 1A @ 25 VDC
- INITIAL CONTACT RESISTANCE: 30 m ohms max.
- INSULATION RESISTANCE: 100 M ohms min.
- DIELECTRIC STRENGTH: 500 V AC (50-60 Hz) between open terminals and between the frame and terminal.
- OPERATING LIFE: 10,000 cycles without load
- OPERATING FORCE:  
400 ± 150 gf (3.92 ± 1.47N)
- LOCK TRAVEL: 3.5 ± 0.3mm
- TOTAL TRAVEL: 5 ± 0.3 mm
- OPERATING TEMPERATURE: -20°C to 70°C

### Materials

- HOUSING: PC (UL 94HB)
- SPRING: SUS
- KNOB: POM
- TERMINAL: Silver plated

## PB-62G02-L DPDT LOCK / LATCHING

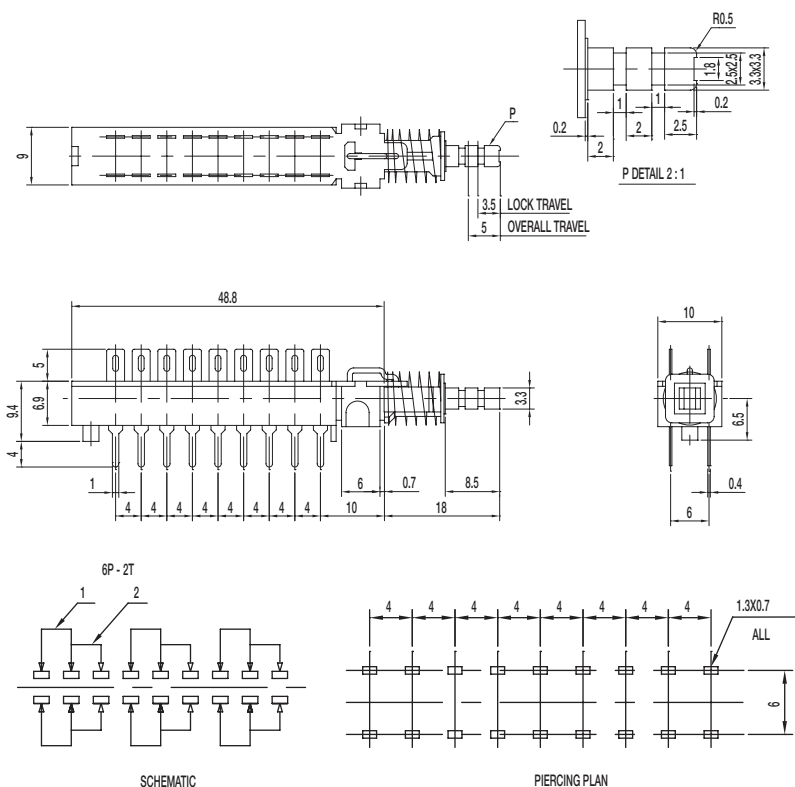

### Specifications

- CONTACT RATING: 1A @ 25 VDC
- INITIAL CONTACT RESISTANCE: 30 m ohms max.
- INSULATION RESISTANCE: 100 M ohms min.
- DIELECTRIC STRENGTH: 500 V AC (50-60 Hz) between open terminals and between the frame and terminal.
- OPERATING LIFE: 10,000 cycles without load
- OPERATING FORCE:  
450 ± 150 gf
- LOCK TRAVEL: 3.5 ± 0.3mm
- TOTAL TRAVEL: 5 ± 0.3 mm
- OPERATING TEMPERATURE: -20°C to 70°C

### Materials

- HOUSING: PC (UL 94HB)
- SPRING: SUS
- KNOB: POM
- TERMINAL: Silver plated



Dimensions are shown: mm  
Specifications and dimensions subject to change



# PB Series Single Pole and Multi-Key Pushbutton Switches

Pushbutton  
A

## PB-22G02-F DPDT NON-LOCK / MOMENTARY

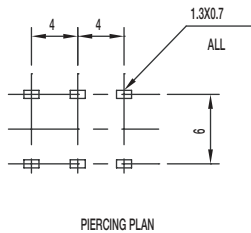
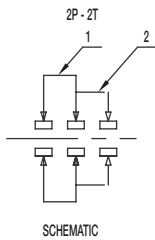
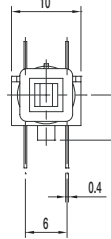
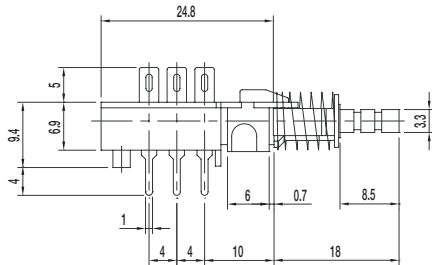
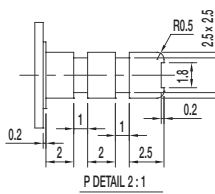
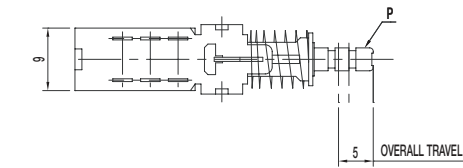

### Specifications

- CONTACT RATING: 1A @ 25 VDC
- INITIAL CONTACT RESISTANCE: 30 m ohms max.
- INSULATION RESISTANCE: 100 M ohms min.
- DIELECTRIC STRENGTH: 500 V AC (50-60 Hz) between open terminals and between the frame and terminal.
- OPERATING LIFE: 10,000 cycles without load
- OPERATING FORCE:  
350 ± 150 gf (3.43 ± 1.47N)
- TOTAL TRAVEL: 5 ± 0.3 mm
- OPERATING TEMPERATURE: -20°C to 70°C

### Materials

- CASE: PC (UL 94HB)
- SPRING: SUS
- KNOB: POM
- TERMINAL: Silver plated

## PB-42G02-F 4PDT NON-LOCK / MOMENTARY

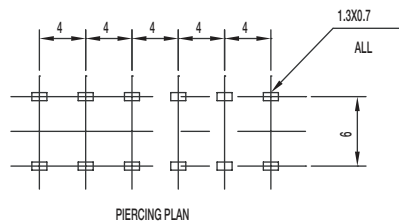
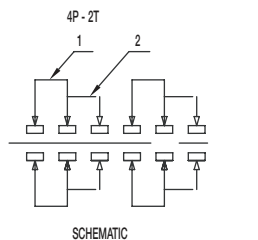
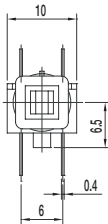
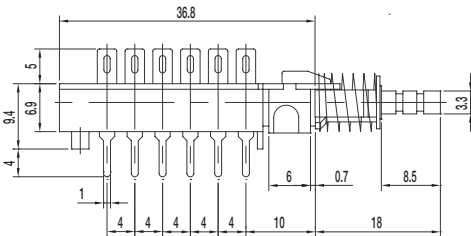
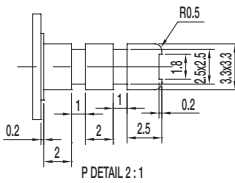
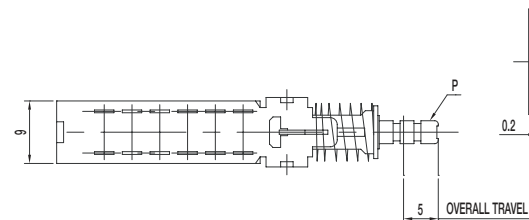

### Specifications

- CONTACT RATING: 1A @ 25 VDC
- INITIAL CONTACT RESISTANCE: 30 m ohms max.
- INSULATION RESISTANCE: 100 M ohms min.
- DIELECTRIC STRENGTH: 500 V AC (50-60 Hz) between open terminals and between the frame and terminal.
- OPERATING LIFE: 10,000 cycles without load
- OPERATING FORCE:  
400 ± 150 gf (3.92 ± 1.47N)
- TOTAL TRAVEL: 5 ± 0.3 mm
- OPERATING TEMPERATURE: -20°C to 70°C

### Materials

- HOUSING: PC (UL 94HB)
- SPRING: SUS
- KNOB: POM
- TERMINAL: Silver plated

# PB Series Single Pole and Multi-Key Pushbutton Switches



A  
Pushbutton

**PB-62G02-F** 6PDT NON-LOCK / MOMENTARY

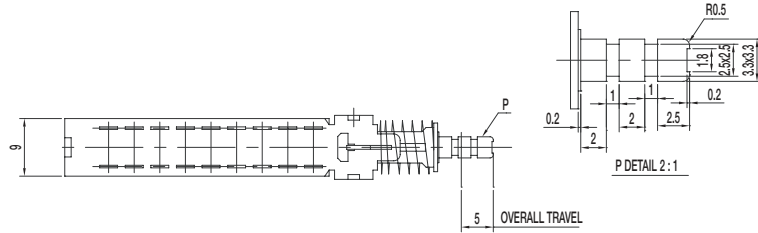

## Specifications

- CONTACT RATING: 1A @ 25 VDC
- INITIAL CONTACT RESISTANCE: 30 m ohms max.
- INSULATION RESISTANCE: 100 M ohms min.
- DIELECTRIC STRENGTH: 500 V AC (50-60 Hz) between open terminals and between the frame and terminal.
- OPERATING LIFE: 10,000 cycles without load
- OPERATING FORCE:  
450 ± 150 gf (4.41 ± 1.47N)
- TOTAL TRAVEL: 5 ± 0.3 mm
- OPERATING TEMPERATURE: -20°C to 70°C

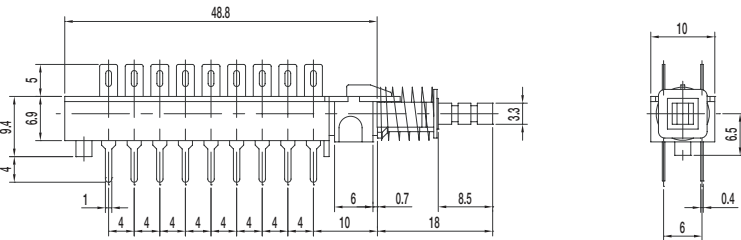

## Materials

- HOUSING: PC (UL 94HB)
- SPRING: SUS
- KNOB: POM
- TERMINAL: Silver plated

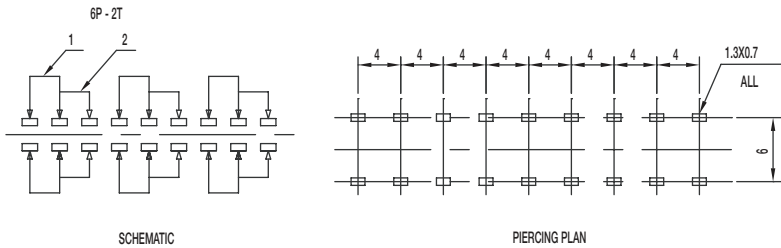

## PB Multi-Key Series

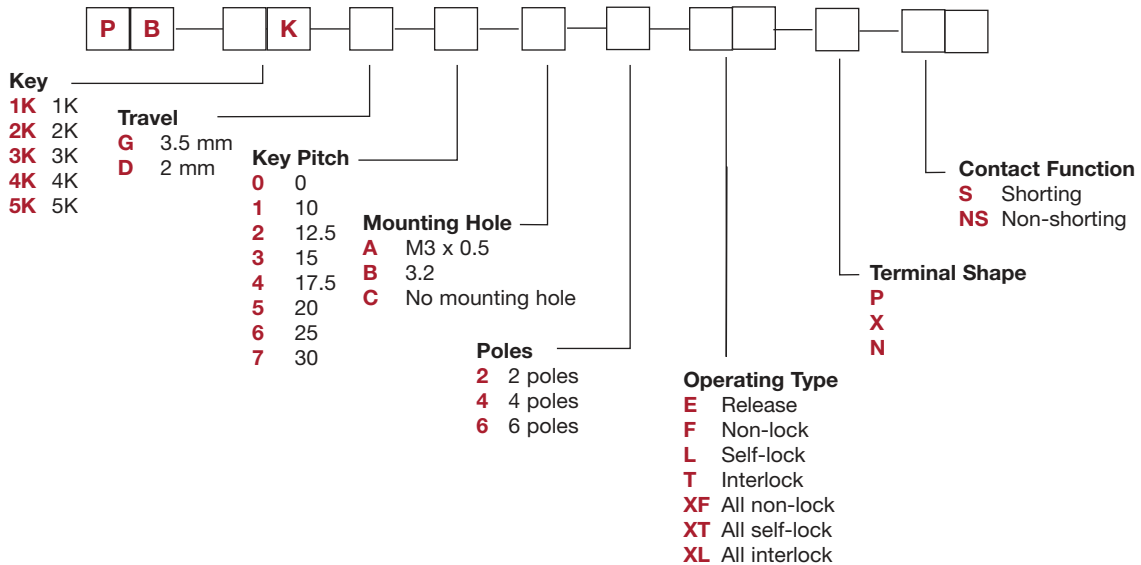

Dimensions are shown: mm  
Specifications and dimensions subject to change



# PB Series Single Pole and Multi-Key Pushbutton Switches

Pushbutton  
A

## PB Multi-Key Series

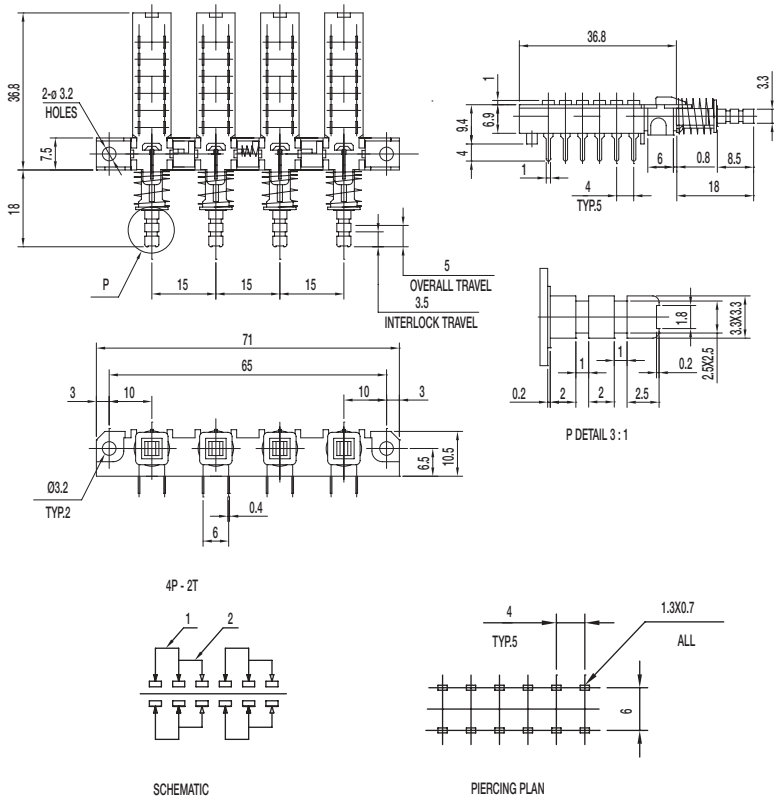

### Specifications

- CONTACT RATING: 0.3A @ 30 VDC
- INITIAL CONTACT RESISTANCE: 30 m ohms max.
- INSULATION RESISTANCE: 100 M ohms min.
- DIELECTRIC STRENGTH: 500 V AC (50-60 Hz) between open terminals and between the frame and terminal.
- OPERATING LIFE: 10,000 cycles without load
- OPERATING FORCE:  
250 ± 100 gf (2.45 ± 0.98N)
- TOTAL TRAVEL: 3 ± 0.3 mm
- OPERATING TEMPERATURE: -20°C to 70°C

### Materials

- CASE: PC (UL 94HB)
- PLASTIC CLIP: POM (UL 94HB)
- SPRING: SUS
- KNOB: POM
- TERMINAL: Silver plated