

BUK7618-55

N-channel TrenchMOS standard level FET

Rev. 2 — 26 April 2011

Product data sheet

1. Product profile

1.1 General description

Standard level N-channel enhancement mode Field-Effect Transistor (FET) in a plastic package using TrenchMOS technology. This product has been designed and qualified to the appropriate AEC standard for use in automotive critical applications.

1.2 Features and benefits

- AEC Q101 compliant
- Electrostatically robust due to integrated protection diodes
- Low conduction losses due to low on-state resistance

1.3 Applications

- Automotive and general purpose power switching

1.4 Quick reference data

Table 1. Quick reference data

Symbol	Parameter	Conditions	Min	Typ	Max	Unit
V_{DS}	drain-source voltage	$T_j \geq 25\text{ °C}; T_j \leq 175\text{ °C}$	-	-	55	V
I_D	drain current	$T_{mb} = 25\text{ °C}$	-	-	57	A
P_{tot}	total power dissipation		-	-	125	W
Static characteristics						
$R_{DS(on)}$	drain-source on-state resistance	$V_{GS} = 10\text{ V}; I_D = 25\text{ A}; T_j = 25\text{ °C}$	-	15	18	m Ω
Avalanche ruggedness						
$E_{DS(AL)S}$	non-repetitive drain-source avalanche energy	$I_D = 50\text{ A}; V_{sup} \leq 25\text{ V}; R_{GS} = 50\text{ }\Omega; V_{GS} = 10\text{ V}; T_{j(init)} = 25\text{ °C}; \text{unclamped}$	-	-	125	mJ

2. Pinning information

Table 2. Pinning information

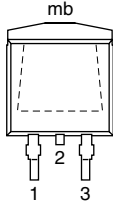
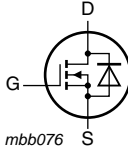
Pin	Symbol	Description	Simplified outline	Graphic symbol
1	G	gate		
2	D	drain		
3	S	source		
mb	D	mounting base; connected to drain		

SOT404 (D2PAK)

3. Ordering information

Table 3. Ordering information

Type number	Package		Version
	Name	Description	
BUK7618-55	D2PAK	plastic single-ended surface-mounted package (D2PAK); 3 leads (one lead cropped)	SOT404

4. Limiting values

Table 4. Limiting values

In accordance with the Absolute Maximum Rating System (IEC 60134).

Symbol	Parameter	Conditions	Min	Max	Unit
V_{DS}	drain-source voltage	$T_j \geq 25\text{ °C}; T_j \leq 175\text{ °C}$	-	55	V
V_{DGR}	drain-gate voltage	$R_{GS} = 20\text{ k}\Omega$	-	55	V
V_{GS}	gate-source voltage		-16	16	V
I_D	drain current	$T_{mb} = 25\text{ °C}$	-	57	A
		$T_{mb} = 100\text{ °C}$	-	40	A
I_{DM}	peak drain current	$T_{mb} = 25\text{ °C};$ pulsed	-	228	A
P_{tot}	total power dissipation	$T_{mb} = 25\text{ °C}$	-	125	W
T_{stg}	storage temperature		-55	175	°C
T_j	junction temperature		-55	175	°C
Source-drain diode					
I_S	source current	$T_{mb} = 25\text{ °C}$	-	57	A
I_{SM}	peak source current	pulsed; $T_{mb} = 25\text{ °C}$	-	200	A
Avalanche ruggedness					
$E_{DS(AL)S}$	non-repetitive drain-source avalanche energy	$I_D = 50\text{ A}; V_{sup} \leq 25\text{ V}; R_{GS} = 50\ \Omega;$ $V_{GS} = 10\text{ V}; T_{j(init)} = 25\text{ °C};$ unclamped	-	125	mJ
Electrostatic discharge					
V_{esd}	electrostatic discharge voltage	HBM; $C = 100\text{ pF}; R = 1.5\text{ k}\Omega;$ (all pins)	-	2	kV

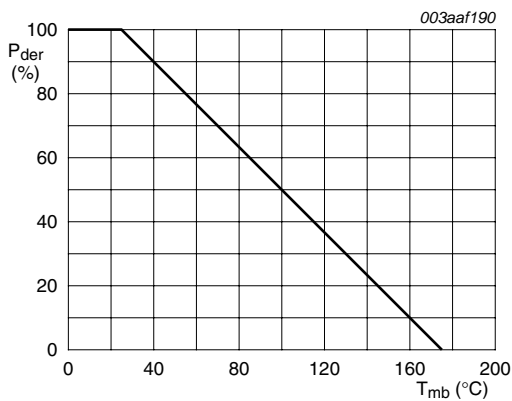

$$P_{der} = \frac{P_{tot}}{P_{tot(25^\circ\text{C})}} \times 100\%$$

Fig 1. Normalized total power dissipation as a function of mounting base temperature

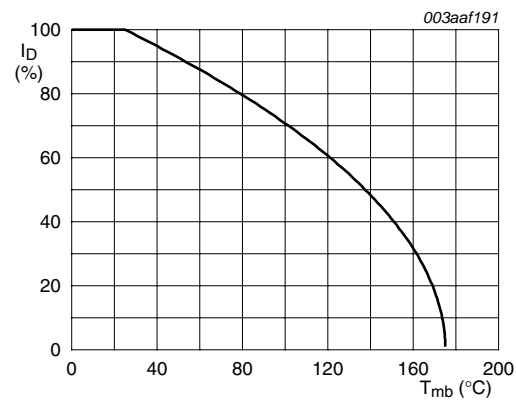

$$I_{der} = \frac{I_D}{I_{D(25^\circ\text{C})}} \times 100\%$$

$V_{GS} \geq 5\text{ V}$

Fig 2. Normalized continuous drain current as a function of mounting base temperature

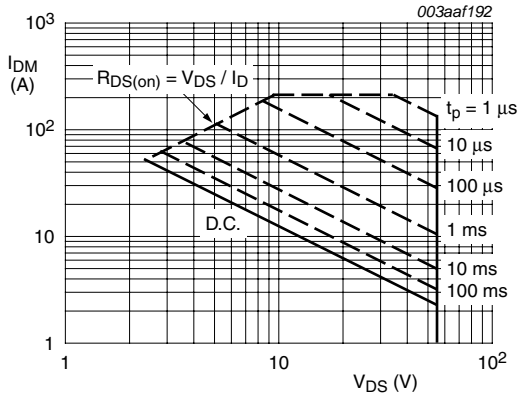

$T_{mb} = 25\text{ }^{\circ}\text{C}$; I_{DM} is single pulse

Fig 3. Safe operating area; continuous and peak drain currents as a function of drain-source voltage

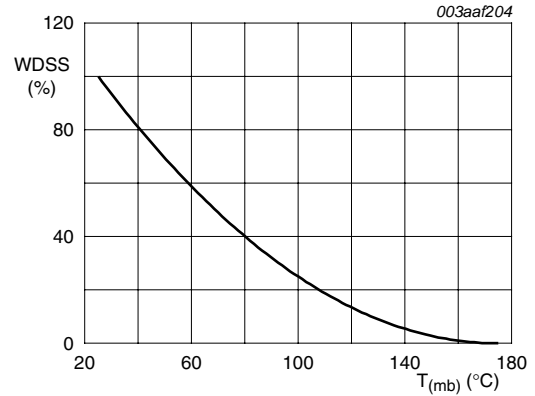

$I_D = 75\text{ A}$

Fig 4. Normalised drain-source avalanche energy as a function of mounting-base temperature.

5. Thermal characteristics

Table 5. Thermal characteristics

Symbol	Parameter	Conditions	Min	Typ	Max	Unit
$R_{th(j-mb)}$	thermal resistance from junction to mounting base		-	-	1.2	K/W
$R_{th(j-a)}$	thermal resistance from junction to ambient	minimum footprint; FR4 board	-	50	-	K/W

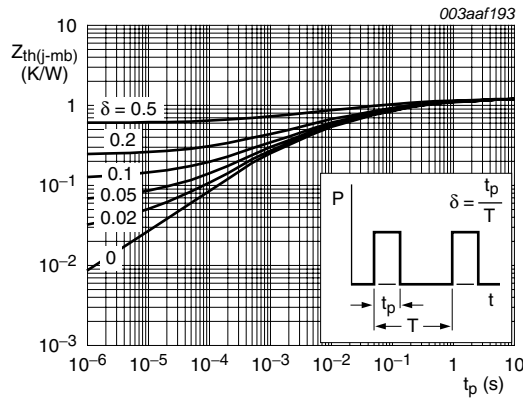

Fig 5. Transient thermal impedance from junction to mounting base as a function of pulse duration

6. Characteristics

Table 6. Characteristics

Symbol	Parameter	Conditions	Min	Typ	Max	Unit
Static characteristics						
$V_{(BR)DSS}$	drain-source breakdown voltage	$I_D = 0.25 \text{ mA}; V_{GS} = 0 \text{ V}; T_j = 25 \text{ }^\circ\text{C}$	55	-	-	V
		$I_D = 0.25 \text{ mA}; V_{GS} = 0 \text{ V}; T_j = -55 \text{ }^\circ\text{C}$	50	-	-	V
$V_{GS(th)}$	gate-source threshold voltage	$I_D = 1 \text{ mA}; V_{DS} = V_{GS}; T_j = 25 \text{ }^\circ\text{C}$	2	3	4	V
		$I_D = 1 \text{ mA}; V_{DS} = V_{GS}; T_j = 175 \text{ }^\circ\text{C}$	1	-	-	V
		$I_D = 1 \text{ mA}; V_{DS} = V_{GS}; T_j = -55 \text{ }^\circ\text{C}$	-	-	4.4	V
I_{DSS}	drain leakage current	$V_{DS} = 55 \text{ V}; V_{GS} = 0 \text{ V}; T_j = 175 \text{ }^\circ\text{C}$	-	-	500	μA
		$V_{DS} = 55 \text{ V}; V_{GS} = 0 \text{ V}; T_j = 25 \text{ }^\circ\text{C}$	-	0.05	10	μA
I_{GSS}	gate leakage current	$V_{GS} = 10 \text{ V}; V_{DS} = 0 \text{ V}; T_j = 25 \text{ }^\circ\text{C}$	-	0.02	1	μA
		$V_{GS} = -10 \text{ V}; V_{DS} = 0 \text{ V}; T_j = 25 \text{ }^\circ\text{C}$	-	0.02	1	μA
		$V_{GS} = 10 \text{ V}; V_{DS} = 0 \text{ V}; T_j = 175 \text{ }^\circ\text{C}$	-	-	20	μA
		$V_{GS} = -10 \text{ V}; V_{DS} = 0 \text{ V}; T_j = 175 \text{ }^\circ\text{C}$	-	-	20	μA
$R_{DS(on)}$	drain-source on-state resistance	$V_{GS} = 10 \text{ V}; I_D = 25 \text{ A}; T_j = 175 \text{ }^\circ\text{C}$	-	-	38	m Ω
		$V_{GS} = 10 \text{ V}; I_D = 25 \text{ A}; T_j = 25 \text{ }^\circ\text{C}$	-	15	18	m Ω
$V_{(BR)GSS}$	gate-source breakdown voltage	$V_{DS} = 0 \text{ V}; T_j = 25 \text{ }^\circ\text{C}; I_G = 1 \text{ mA}$	16	-	-	V
		$V_{DS} = 0 \text{ V}; T_j = 25 \text{ }^\circ\text{C}; I_G = -1 \text{ mA}$	16	-	-	V
Dynamic characteristics						
C_{iss}	input capacitance	$V_{GS} = 0 \text{ V}; V_{DS} = 25 \text{ V}; f = 1 \text{ MHz}; T_j = 25 \text{ }^\circ\text{C}$	-	1500	2000	pF
C_{oss}	output capacitance		-	370	470	pF
C_{rss}	reverse transfer capacitance		-	170	250	pF
$t_{d(on)}$	turn-on delay time	$V_{DS} = 30 \text{ V}; R_L = 1.2 \text{ } \Omega; V_{GS} = 10 \text{ V}; R_{G(ext)} = 10 \text{ } \Omega; I_D = 25 \text{ A}; T_j = 25 \text{ }^\circ\text{C}$	-	15	22	ns
t_r	rise time		-	30	60	ns
$t_{d(off)}$	turn-off delay time		-	35	50	ns
t_f	fall time		-	25	38	ns
L_D	internal drain inductance	measured from upper edge of drain mounting base to centre of die; $T_j = 25 \text{ }^\circ\text{C}$	-	2.5	-	nH
L_S	internal source inductance	measured from source lead soldering point to source bond pad; $T_j = 25 \text{ }^\circ\text{C}$	-	7.5	-	nH
g_{fs}	transfer conductance	$V_{DS} = 25 \text{ V}; I_D = 25 \text{ A}; T_j = 25 \text{ }^\circ\text{C}$	6	30	-	S
Source-drain diode						
V_{SD}	source-drain voltage	$I_S = 50 \text{ A}; V_{GS} = 0 \text{ V}; T_j = 25 \text{ }^\circ\text{C}$	-	1	-	V
		$I_S = 25 \text{ A}; V_{GS} = 0 \text{ V}; T_j = 25 \text{ }^\circ\text{C}$	-	0.95	1.2	V
t_{rr}	reverse recovery time	$I_S = 50 \text{ A}; dI_S/dt = -100 \text{ A}/\mu\text{s}; V_{GS} = -10 \text{ V}; V_{DS} = 30 \text{ V}; T_j = 25 \text{ }^\circ\text{C}$	-	48	-	ns
Q_r	recovered charge		-	0.1	-	μC

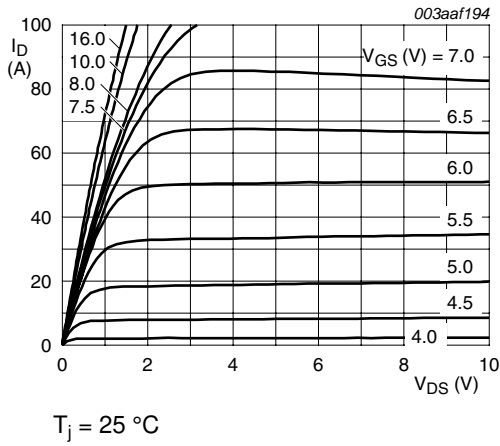

Fig 6. Output characteristics: drain current as a function of drain-source voltage; typical values

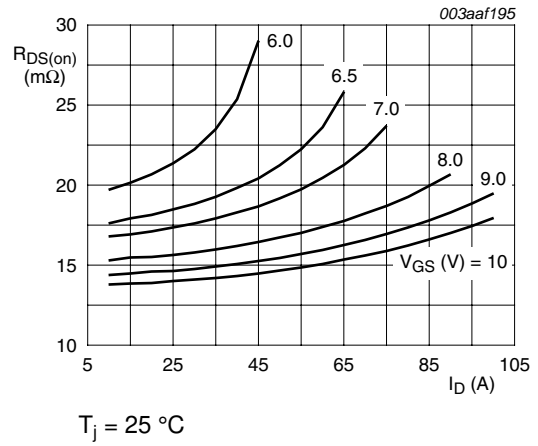

Fig 7. Drain-source on-state resistance as a function of drain current; typical values

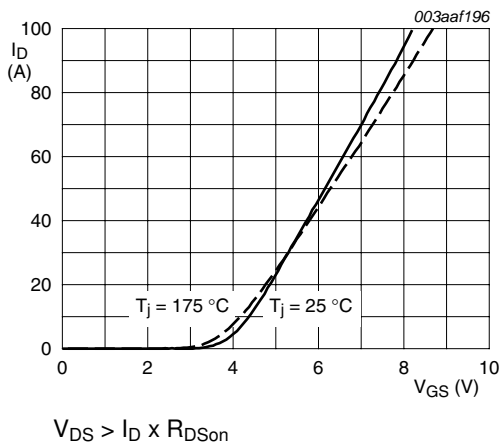

Fig 8. Transfer characteristics: drain current as a function of gate-source voltage; typical values

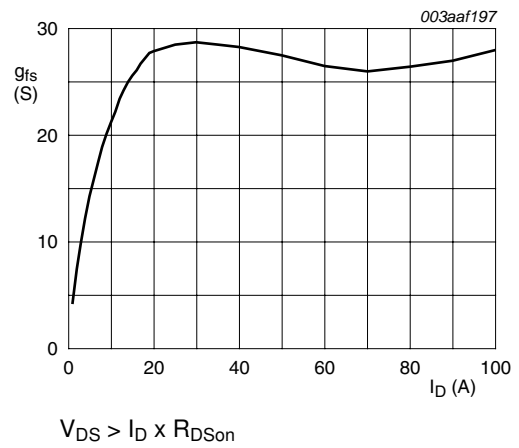
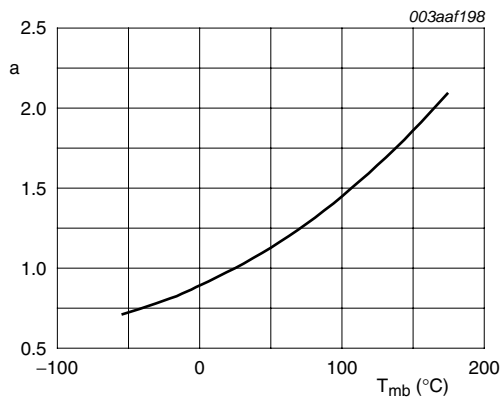

Fig 9. Forward transconductance as a function of drain current; typical values



$$a = \frac{R_{DSon}}{R_{DSon(25^{\circ}C)}}$$

Fig 10. Normalized drain-source on-state resistance factor as a function of junction temperature

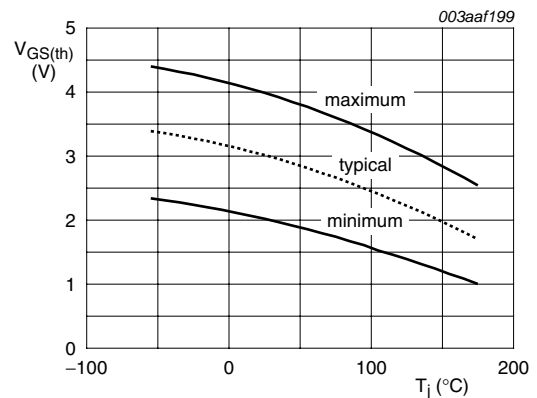
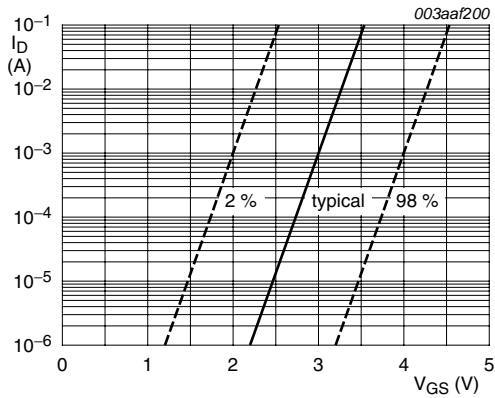
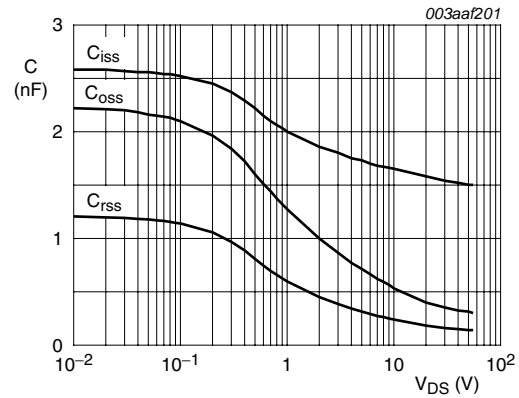

Fig 11. Gate-source threshold voltage as a function of junction temperature



$T_j = 25\text{ }^\circ\text{C}; V_{DS} = V_{GS}$

Fig 12. Sub-threshold drain current as a function of gate-source voltage



$V_{GS} = 0\text{ V}; f = 1\text{ MHz}$

Fig 13. Input, output and reverse transfer capacitances as a function of drain-source voltage; typical values

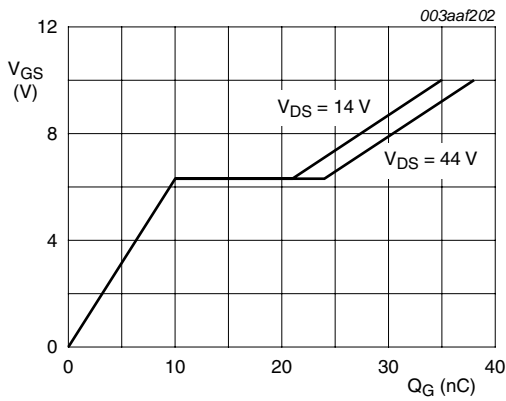

$T_j = 25\text{ }^\circ\text{C}; I_D = 50\text{ A}$

Fig 14. Gate-source voltage as a function of gate charge; typical values

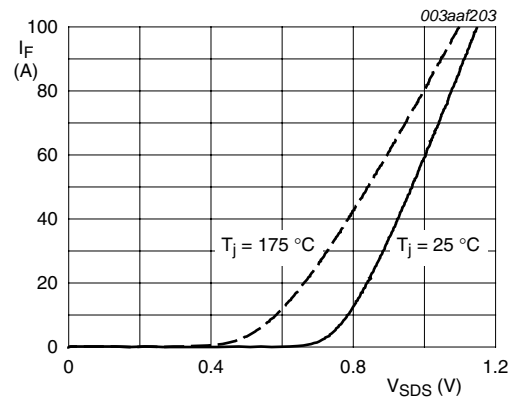

$V_{GS} = 0\text{ V}$

Fig 15. Source (diode forward) current as a function of source-drain (diode forward) voltage; typical values

7. Package outline

Plastic single-ended surface-mounted package (D2PAK); 3 leads (one lead cropped)

SOT404

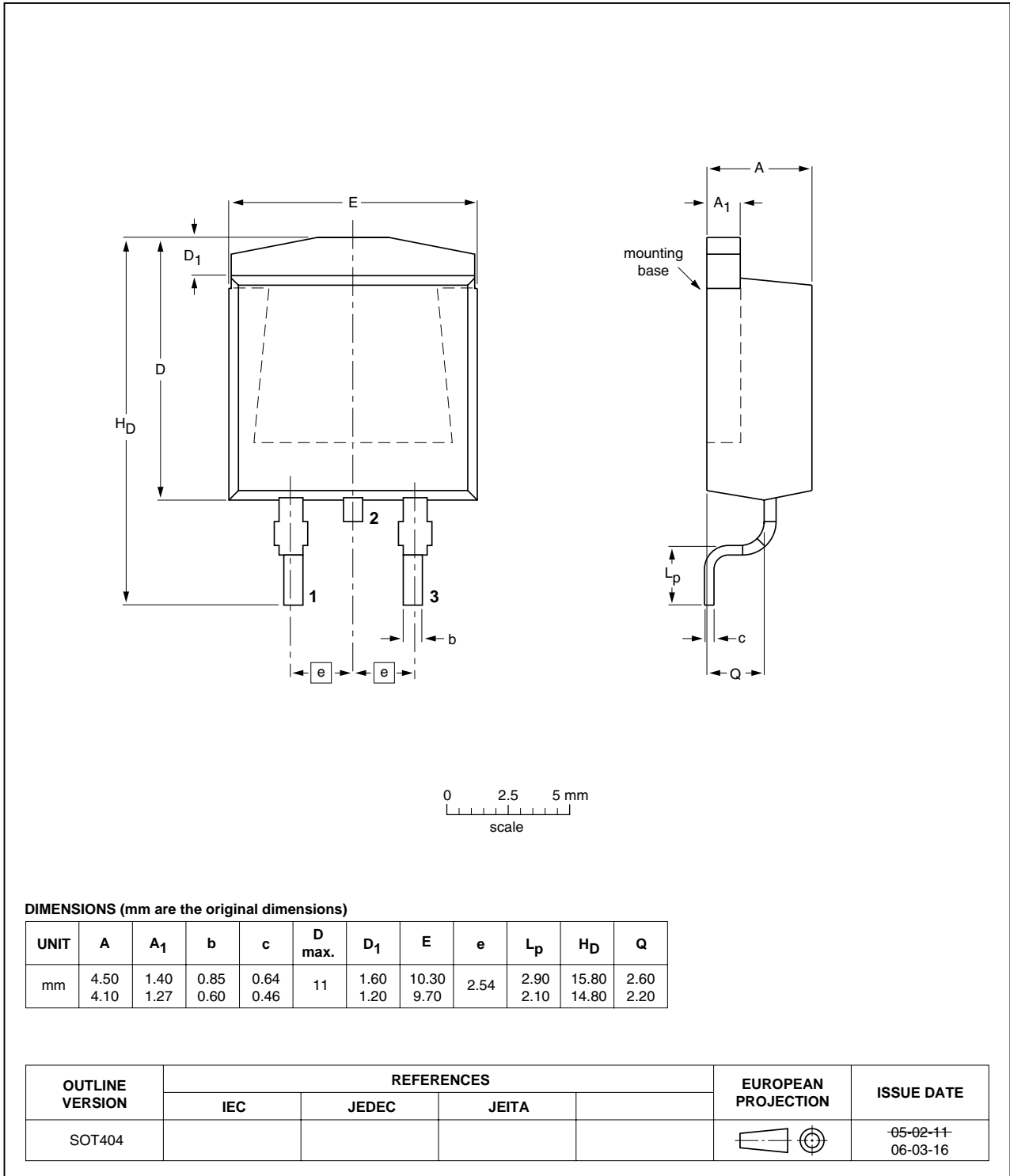

Fig 16. Package outline SOT404 (D2PAK)

8. Revision history

Table 7. Revision history

Document ID	Release date	Data sheet status	Change notice	Supersedes
BUK7618-55 v.2	20110426	Product data sheet	-	BUK7618-55_1
Modifications:	<ul style="list-style-type: none">• The format of this data sheet has been redesigned to comply with the new identity guidelines of NXP.• Legal texts have been adapted to the new company name where appropriate.			
BUK7618-55_1	19980401	Product specification	-	-

9. Legal information

9.1 Data sheet status

Document status [1] [2]	Product status [3]	Definition
Objective [short] data sheet	Development	This document contains data from the objective specification for product development.
Preliminary [short] data sheet	Qualification	This document contains data from the preliminary specification.
Product [short] data sheet	Production	This document contains the product specification.

[1] Please consult the most recently issued document before initiating or completing a design.

[2] The term 'short data sheet' is explained in section "Definitions".

[3] The product status of device(s) described in this document may have changed since this document was published and may differ in case of multiple devices. The latest product status information is available on the Internet at URL <http://www.nexperia.com>.

9.2 Definitions

Preview — The document is a preview version only. The document is still subject to formal approval, which may result in modifications or additions. Nexperia does not give any representations or warranties as to the accuracy or completeness of information included herein and shall have no liability for the consequences of use of such information.

Draft — The document is a draft version only. The content is still under internal review and subject to formal approval, which may result in modifications or additions. Nexperia does not give any representations or warranties as to the accuracy or completeness of information included herein and shall have no liability for the consequences of use of such information.

Short data sheet — A short data sheet is an extract from a full data sheet with the same product type number(s) and title. A short data sheet is intended for quick reference only and should not be relied upon to contain detailed and full information. For detailed and full information see the relevant full data sheet, which is available on request via the local Nexperia sales office. In case of any inconsistency or conflict with the short data sheet, the full data sheet shall prevail.

Product specification — The information and data provided in a Product data sheet shall define the specification of the product as agreed between Nexperia and its customer, unless Nexperia and customer have explicitly agreed otherwise in writing. In no event however, shall an agreement be valid in which the Nexperia product is deemed to offer functions and qualities beyond those described in the Product data sheet.

9.3 Disclaimers

Limited warranty and liability — Information in this document is believed to be accurate and reliable. However, Nexperia does not give any representations or warranties, expressed or implied, as to the accuracy or completeness of such information and shall have no liability for the consequences of use of such information.

In no event shall Nexperia be liable for any indirect, incidental, punitive, special or consequential damages (including - without limitation - lost profits, lost savings, business interruption, costs related to the removal or replacement of any products or rework charges) whether or not such damages are based on tort (including negligence), warranty, breach of contract or any other legal theory.

Notwithstanding any damages that customer might incur for any reason whatsoever, Nexperia's aggregate and cumulative liability towards customer for the products described herein shall be limited in accordance with the *Terms and conditions of commercial sale* of Nexperia.

Right to make changes — Nexperia reserves the right to make changes to information published in this document, including without limitation specifications and product descriptions, at any time and without notice. This document supersedes and replaces all information supplied prior to the publication hereof.

Suitability for use in automotive applications — This Nexperia product has been qualified for use in automotive applications. The product is not designed, authorized or warranted to be suitable for use in medical, military, aircraft, space or life support equipment, nor in applications where failure or malfunction of a Nexperia product can reasonably be expected to result in personal injury, death or severe property or environmental damage. Nexperia accepts no liability for inclusion and/or use of Nexperia products in such equipment or applications and therefore such inclusion and/or use is at the customer's own risk.

Quick reference data — The Quick reference data is an extract of the product data given in the Limiting values and Characteristics sections of this document, and as such is not complete, exhaustive or legally binding.

Applications — Applications that are described herein for any of these products are for illustrative purposes only. Nexperia makes no representation or warranty that such applications will be suitable for the specified use without further testing or modification.

Customers are responsible for the design and operation of their applications and products using Nexperia products, and Nexperia accepts no liability for any assistance with applications or customer product design. It is customer's sole responsibility to determine whether the Nexperia product is suitable and fit for the customer's applications and products planned, as well as for the planned application and use of customer's third party customer(s). Customers should provide appropriate design and operating safeguards to minimize the risks associated with their applications and products.

Nexperia does not accept any liability related to any default, damage, costs or problem which is based on any weakness or default in the customer's applications or products, or the application or use by customer's third party customer(s). Customer is responsible for doing all necessary testing for the customer's applications and products using Nexperia products in order to avoid a default of the applications and the products or of the application or use by customer's third party customer(s). Nexperia does not accept any liability in this respect.

Limiting values — Stress above one or more limiting values (as defined in the Absolute Maximum Ratings System of IEC 60134) will cause permanent damage to the device. Limiting values are stress ratings only and (proper) operation of the device at these or any other conditions above those given in the Recommended operating conditions section (if present) or the

Characteristics sections of this document is not warranted. Constant or repeated exposure to limiting values will permanently and irreversibly affect the quality and reliability of the device.

Terms and conditions of commercial sale — Nexperia products are sold subject to the general terms and conditions of commercial sale, as published at <http://www.nexperia.com/profile/terms>, unless otherwise agreed in a valid written individual agreement. In case an individual agreement is concluded only the terms and conditions of the respective agreement shall apply. Nexperia hereby expressly objects to applying the customer's general terms and conditions with regard to the purchase of Nexperia products by customer.

No offer to sell or license — Nothing in this document may be interpreted or construed as an offer to sell products that is open for acceptance or the grant, conveyance or implication of any license under any copyrights, patents or other industrial or intellectual property rights.

Export control — This document as well as the item(s) described herein may be subject to export control regulations. Export might require a prior authorization from national authorities.

9.4 Trademarks

Notice: All referenced brands, product names, service names and trademarks are the property of their respective owners.

10. Contact information

For more information, please visit: <http://www.nexperia.com>

For sales office addresses, please send an email to: salesaddresses@nexperia.com

11. Contents

1	Product profile	1
1.1	General description	1
1.2	Features and benefits	1
1.3	Applications	1
1.4	Quick reference data	1
2	Pinning information	2
3	Ordering information	2
4	Limiting values	3
5	Thermal characteristics	4
6	Characteristics	5
7	Package outline	8
8	Revision history	9
9	Legal information	10
9.1	Data sheet status	10
9.2	Definitions	10
9.3	Disclaimers	10
9.4	Trademarks	11
10	Contact information	11