

PRODUCT NO.	ROWS	SIGNAL				POWER				
		E2	4	3	2	1	P3	P2	P1	E1
51915-335-- NOTE 3	D C B A		H	H	H	H	PA	PA	PA	
		G	G	G	G					
		F	F	F	F					
		E	E	E	E					

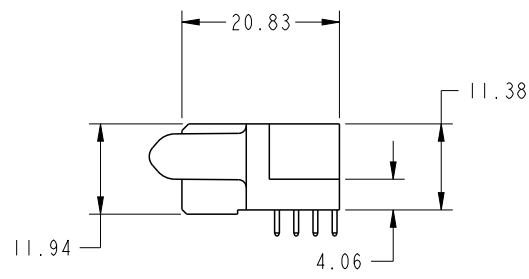

CODE	DIM "M" MATING LENGTH	CONTACT TYPE
PA	[1.07]	POWER
H	[N/A]	SIGNAL
G	[N/A]	SIGNAL
F	[N/A]	SIGNAL
E	[N/A]	SIGNAL

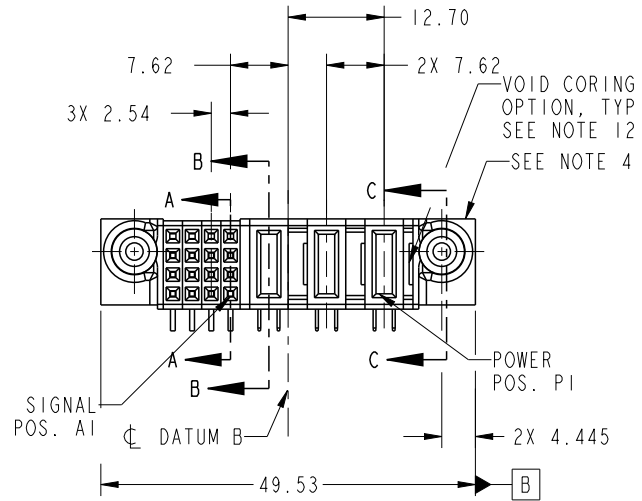

Copyright FCI.

spec ref	SEE NOTES		
tolerance std	TOLERANCES UNLESS OTHERWISE SPECIFIED		
SEE NOTES	linear	0.X	±0.50
		0.XX	±0.25
		0.XXX	±0.10
surface	angular	0°	±2°

dr	Shi Guang	2011/12/14
eng	Luo Weller	2013/03/04
chr	-	-
appr	Pei-Ming Zheng	2013/03/04

projection	
product family	PwrBlade

size	A4	scale	1:1
ecn no	-	rel level	Released

	title	3ACP+16S	dwg no	51915-335	rev	A
www.fci.com	cat. no.		Product - Customer Drw	sheet 1 of 4		

PRODUCT NUMBER

51915-335_
NOTE 3

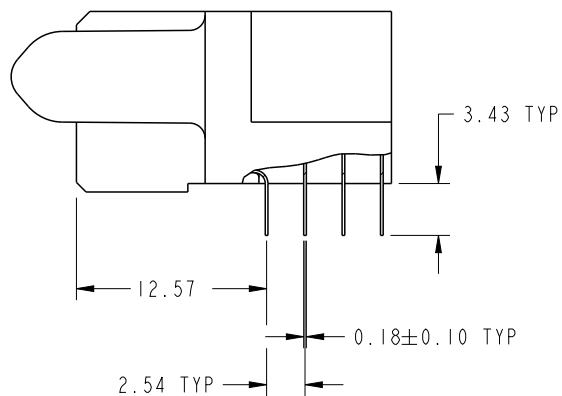

BROKEN-OUT SECTION A-A
SCALE 2:1

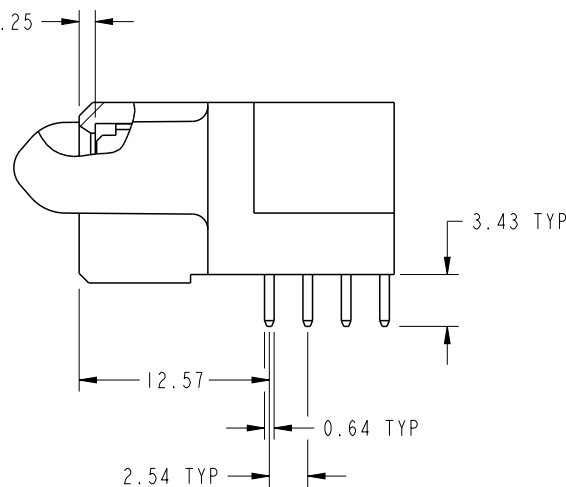

BROKEN-OUT SECTION B-B
SCALE 2:1

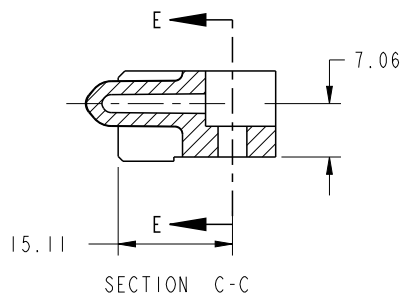

SECTION C-C

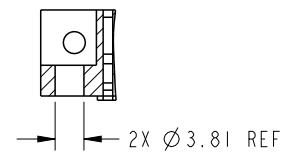

PARTIAL SECTION E-E

dr	Shi Guang	2011/12/14	projection 	MM ←————→	size	A4	scale	1:1
eng	Luo Weller	2013/03/04			ecn no	-		
chr	-	-			rel level	Released		
appr	Pei-Ming Zheng	2013/03/04	product family	PwrBlade	rev	A		
	title	3ACP+16S R/A STB RECEPTACLE		dwg no	51915-335			
www.fci.com	cat. no.	Product - Customer Drw			sheet 2 of 4			

PRODUCT NUMBER

51915-335_
NOTE 3

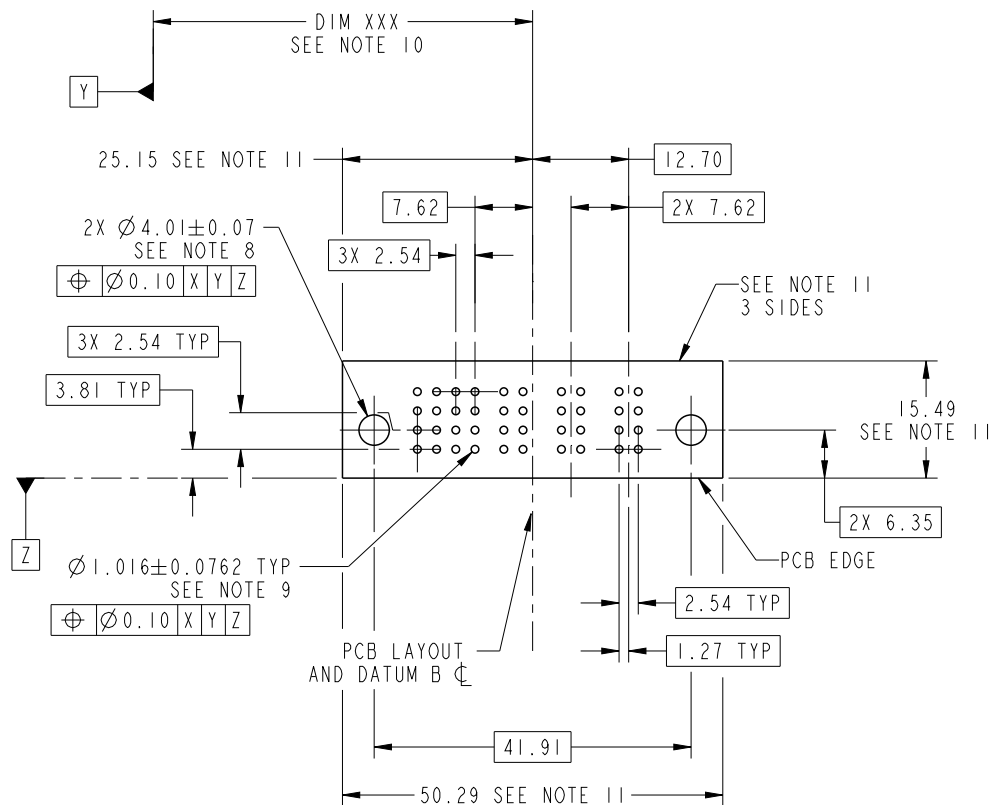

RECOMMENDED PCB LAYOUT

dr	Shi Guang	2011/12/14	projection 	MM 	size	A4	scale	1:1
eng	Luo Weller	2013/03/04			ecn no	-		
chr	-	-			rel level	Released		
appr	Pei-Ming Zheng	2013/03/04	product family	PwrBlade				
	title	3ACP+16S		dwg no	51915-335		rev	A
www.fci.com	cat. no.	R/A STB RECEPTACLE		Product - Customer Drw			sheet 3 of 4	

PRODUCT NUMBER

51915-335__
NOTE 3

NOTES:



1. DIMENSIONS AND TOLERANCES ARE IN ACCORDANCE WITH ASME Y14.5M, 1994 UNLESS OTHERWISE SPECIFIED.

CONNECTOR NOTES:

- 2. HOUSING MATERIAL: UL 94 V-0 GLASS FILLED HIGH-TEMP THERMOPLASTIC
POWER CONTACT MATERIAL: COPPER ALLOY
SIGNAL PIN MATERIAL: COPPER ALLOY
- 3. SEE ITEM 5 & 6 IN PRINT 10064183 FOR PLATING SPEC OF 51915-335 AND 51915-335LF RESPECTIVELY.
- 4. MANUFACTURER'S NAME, DATE CODE AND OPTIONAL P/N TO APPEAR ON THIS SURFACE. THE P/N CAN BE OMITTED IF THERE IS NOT ENOUGH SPACE ON THIS SURFACE.
- 5. PRODUCT SPECIFICATION GS-12-149.
APPLICATION SPECIFICATION BUS-20-067.
- 6. PACKAGED IN TRAYS.

PCB NOTES:

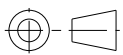
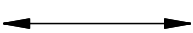
- 7. ALL HOLE DIAMETERS ARE FINISHED HOLE SIZE.
- 8. MOUNTING HOLES, WHERE APPLICABLE, ARE UNPLATED.
- 9. $\varnothing 1.151 \pm 0.025$ DRILLED HOLES PLATED WITH
0.008 MIN SnPb OR Sn OVER 0.03
TO 0.08 Cu PLATING TO ACHIEVE
 $\varnothing 1.02 \pm .07$ HOLE.
- 10. "DIM XXX" TO BE DETERMINED BY THE CUSTOMER.
- 11. CONNECTOR KEEP-OUT ZONE.
- 12. THE VOID CORING IN BETWEEN POWER MODULES, SIGNAL MODULES AND END MODULES ARE OPTIONAL AND THE SHAPE MAY BE DIFFERENT FOR OPTIMIZE THE MOLDING PROCESS. THE VOID CORING WILL NOT EFFECT TO PRODUCT FUNCTION.

dr	Shi Guang	2011/12/14	projection 	MM 	size	A4	scale	1:1			
eng	Luo Weller	2013/03/04			ecn no	-					
chr	-	-			product family	PwrBlade	rel level	Released			
appr	Pei-Ming Zheng	2013/03/04			title	3ACP+16S		dwg no	51915-335	rev	A
www.fci.com		cat. no.	Product - Customer Drw			sheet 4 of 4					



Copyright FCI.