



Datasheet

Part No:
FXP523.A.07.A.001

Description:

Venti Flex PCB Wi-Fi MIMO 2.4/5.8/7.1GHz Antenna with 3 ports with Wi-Fi 6 frequency bands included

Features:

Covers Extended Wi-Fi Frequencies of 2.4-2.5GHz, 5-7.125GHz

Flex PCB MIMO Antenna

Adhesive Tape for ease of installation

Dimensions: 80*20*0.2mm

Cables: 120mm of \varnothing 1.13mm

Connectors: I-PEX MHF® I (U.FL Compatible)

RoHS & Reach Compliant

1.	Introduction	3
2.	Specifications	5
3.	Antenna Characteristics	6
4.	Radiation Patterns	9
5.	Mechanical Drawing	11
6.	Packaging	12
<hr/>		
	Changelog	13

Taoglas makes no warranties based on the accuracy or completeness of the contents of this document and reserv make changes to specifications and product descriptions at any time without notice. Taoglas reserves all rights to this document and the information contained herein. Reproduction, use or disclosure to third parties without express permission is strictly prohibited.



1. Introduction



The FXP523 Venti antenna is a 3-in-1 MIMO, flexible PCB monopole type antenna designed to operate at widely used Wi-Fi frequencies. The FXP524 is a future proof antenna as it has been proven to cover the frequencies required for Wi-Fi 6 applications. The antenna has excellent efficiency and isolation performance for all Wi-Fi applications. Featuring a low profile height of only 0.15mm, the FXP523 is an ideal solution for maintaining high performance while fitting into narrow spaces such as plastic enclosures for laptops, tablets, routers, and other Wi-Fi applications.

The antenna has been designed in a flexible material with a rectangular form-factor and cable connection for an easy installation. The antenna comes with double-sided 3M tape for easy and robust "peel and stick" mounting. The antenna cables feature IPEX connectors for easy installation.

Typical applications include:

- Smart Home
- Routers and Gateways
- Smart Devices
- HD Video Streaming

Many module manufacturers specify peak gain limits for any antennas that are to be connected to that module. Those peak gain limits are based on free-space conditions. In practice, the peak gain of an antenna tested in free-space can degrade by at least 1 or 2dBi when put inside a device. So ideally you should go for a slightly higher peak gain antenna than mentioned on the module specification to compensate for this effect, giving you better performance.

Upon testing of any of our antennas with your device and a selection of appropriate layout, integration technique, or cable, Taoglas can make sure any of our antennas' peak gain will be below the peak gain limits. Taoglas can then issue a specification and/or report for the selected antenna in your device that will clearly show it complying with the peak gain limits, so you can be assured you are meeting regulatory requirements for that module.

For example, a module manufacturer may state that the antenna must have less than 2dBi peak gain, but you don't need to select an embedded antenna that has a peak gain of less than 2dBi in free-space. This will give you a less optimized solution. It is better to go for a slightly higher free-space peak gain of 3dBi or more if available. Once that antenna gets integrated into your device, performance will degrade below this 2dBi peak gain due to the effects of GND plane, surrounding components, and device housing. If you want to be absolutely sure, contact Taoglas and we will test. Choosing a Taoglas antenna with a higher peak gain than what is specified by the module manufacturer and enlisting our help will ensure you are getting the best performance possible without exceeding the peak gain limits.

The Cables and connectors are fully customizable subject to MOQ, for further information please contact your regional Taoglas customer support team for more information.



2. Specifications

Electrical									
Band	Frequency (MHz)	Setup	Efficiency (%)	Average Gain (dB)	Peak Gain (dBi)	Impedance	Max Power Input	Polarization	Radiation Pattern
2.4GHz Wi-Fi	2400~2500	Right Port	41	-3.9	0.2	50Ω	2W	Linear	Omnidirectional
		Centre Port	39	-4	5.7				
		Left Port	28	-5.7	6.6				
5.8GHz Wi-Fi	5150~5850	Right Port	58	-2.3	1				
		Centre Port	45	-3.4	4.4				
		Left Port	49	-3.1	5.1				
7.1GHz Wi-Fi 6	5925~7125	Right Port	31	-5.3	-0.8				
		Centre Port	35	-4.7	4.3				
		Left Port	39	-4.1	4.5				
Mechanical									
Dimensions		80mm X 20mm X 0.1mm							
Antenna Body Material		Polymer							
Cable		3* Black 1.13mm Coaxial Cable							
Cable Length		120mm							
Connector		IPEX MHFHT							
Weight		8g							
Environmental									
Temperature Range		-40°C to 85°C							
Humidity		Non-condensing 65°C 95% RH							

3. Antenna Characteristics

3.1 Return Loss

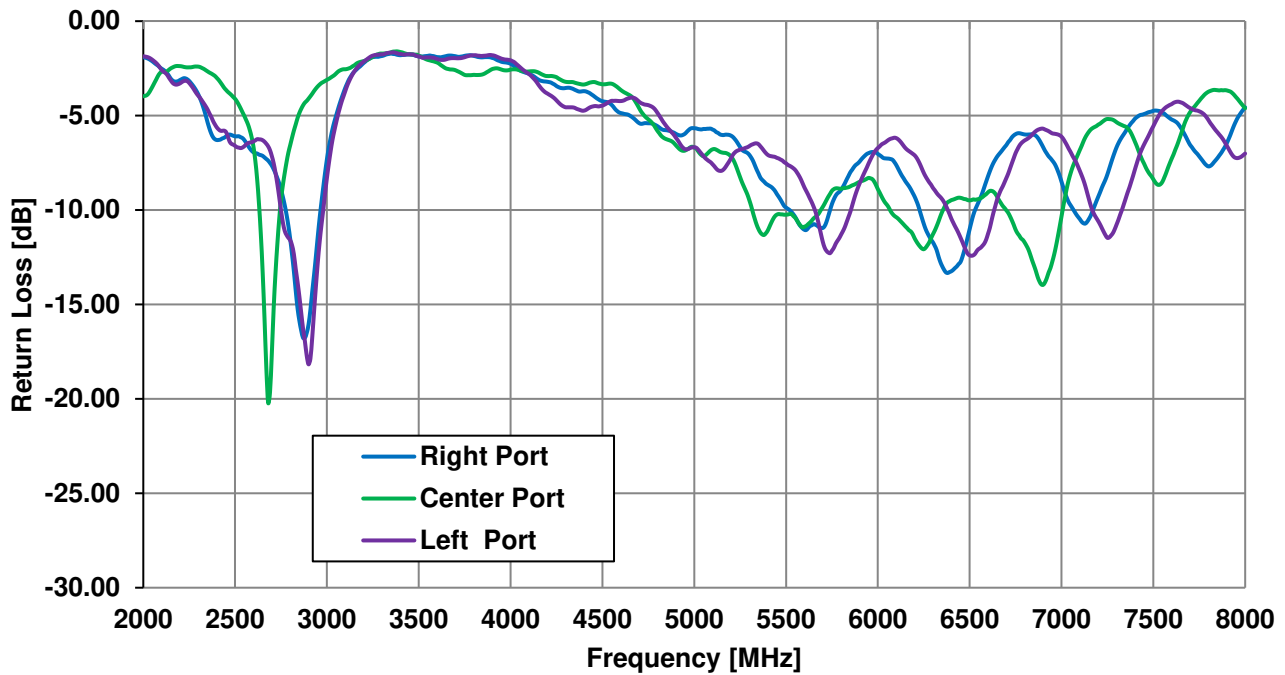

3.2 VSWR

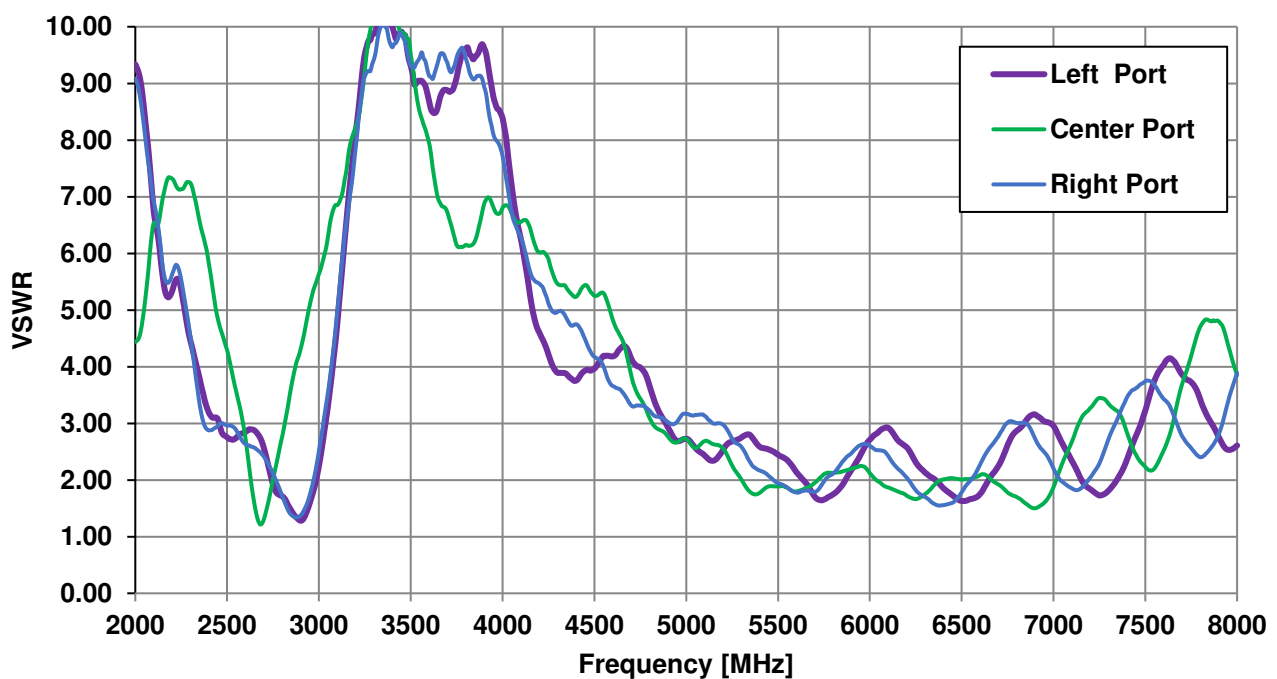

3.3 Efficiency

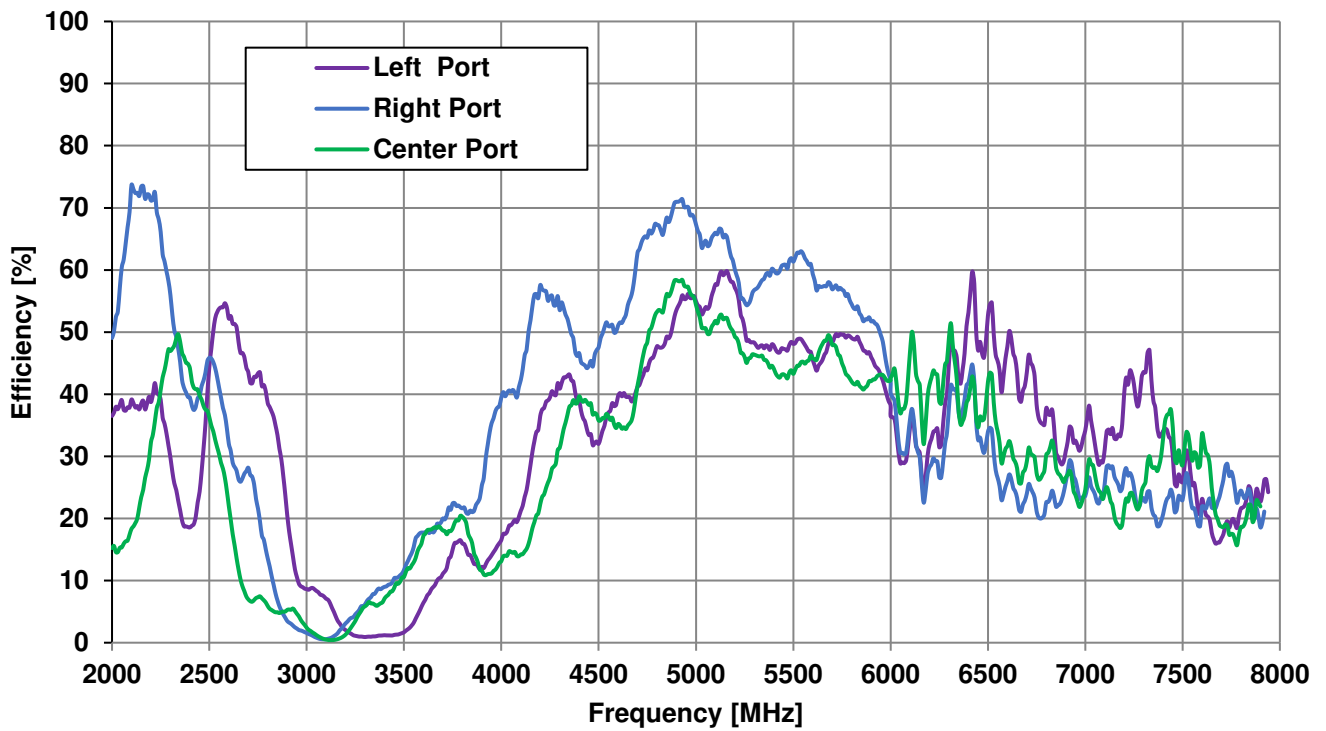

3.4 Peak Gain

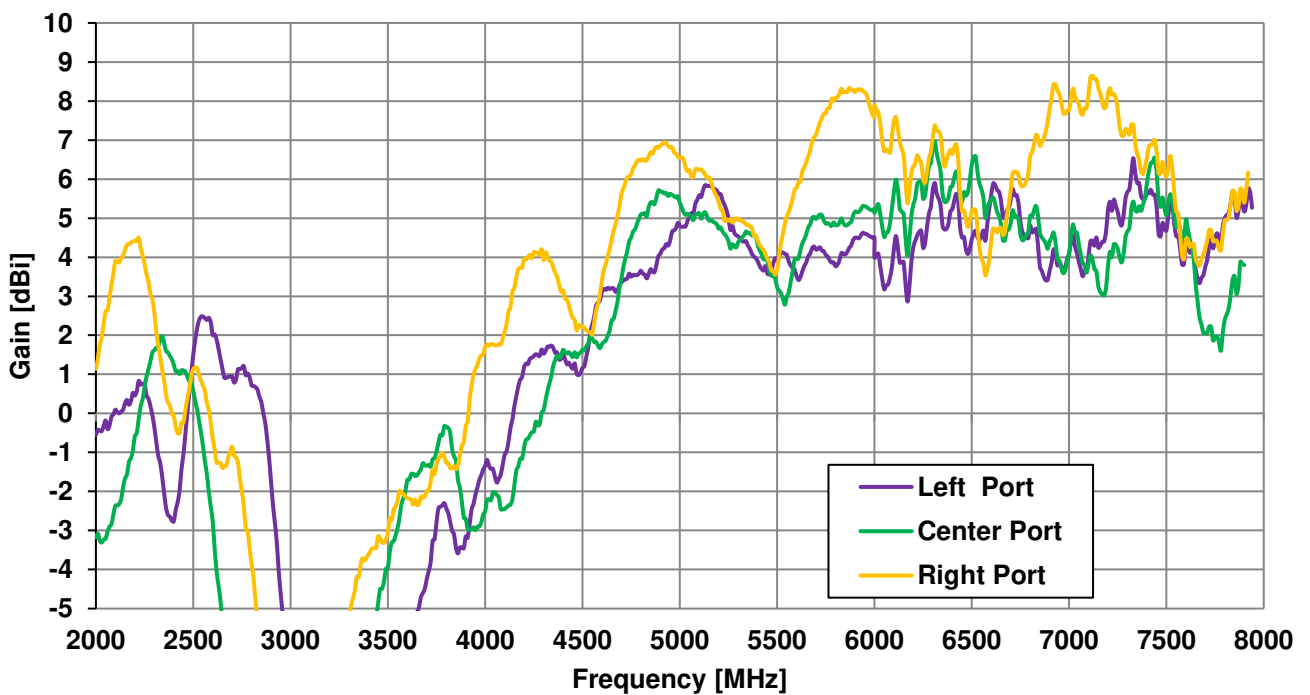

3.5 Average Gain

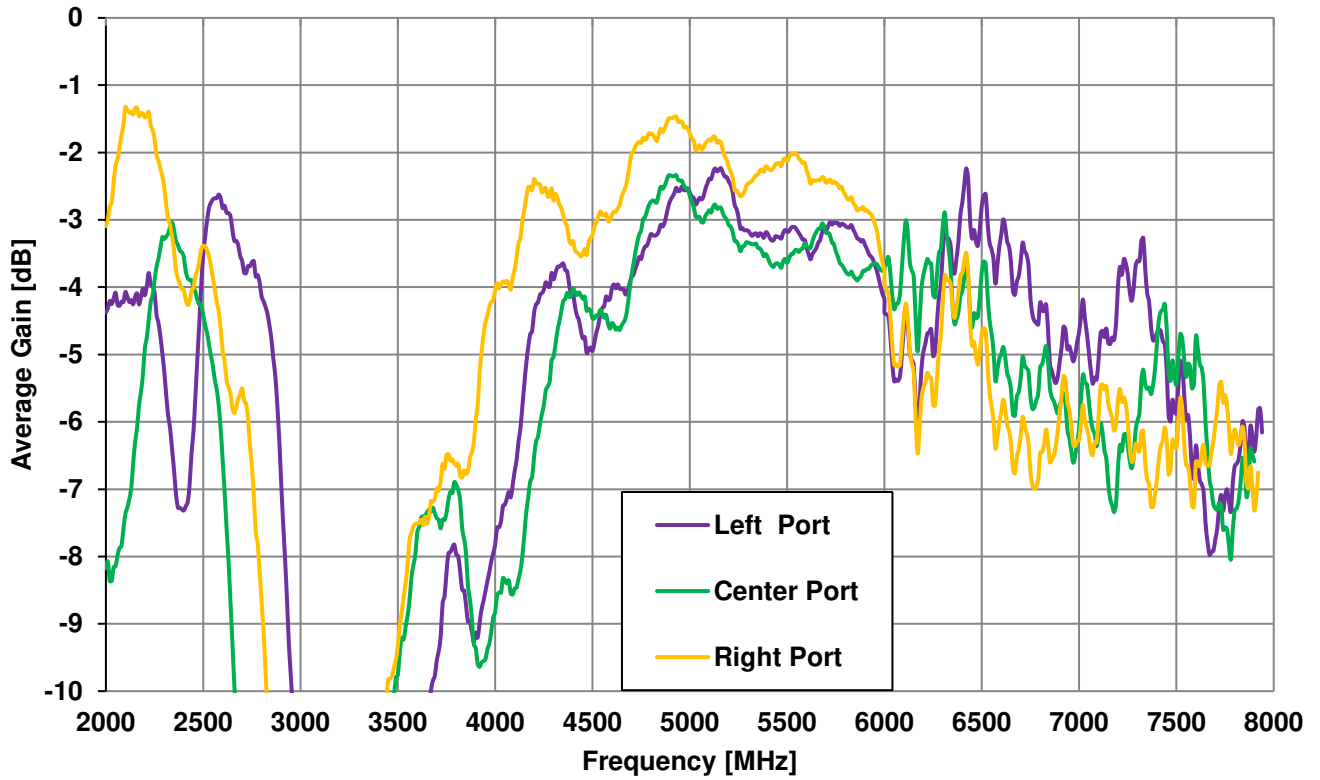

4. Radiation Patterns

4.1 Test Setup – 2mm ABS



4.2 842MHz 3D and 2D Radiation Patterns

Right Port

XY Plane

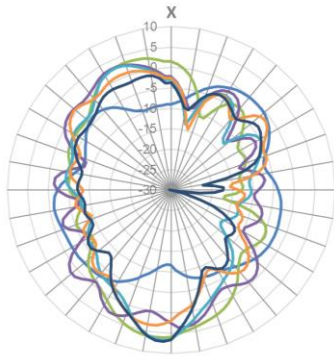

XZ Plane

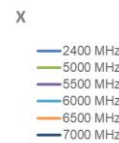
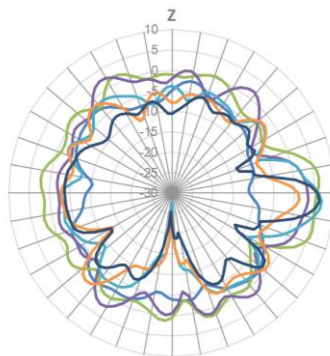

YZ Plane

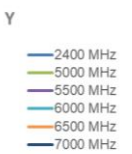
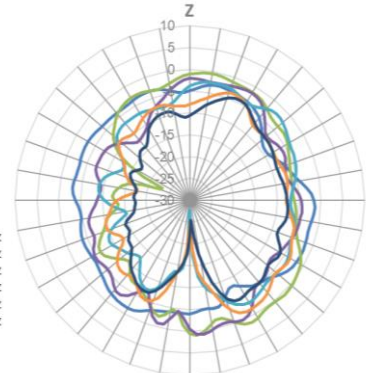

Centre Port

XY Plane

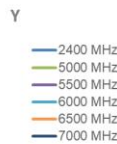
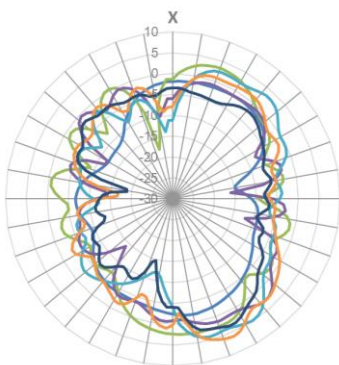

XZ Plane

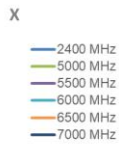
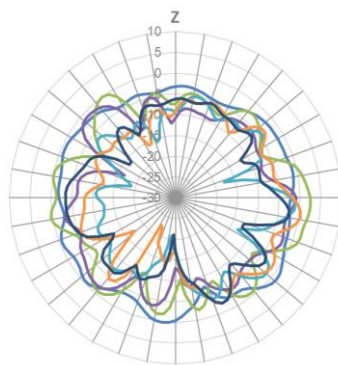

YZ Plane

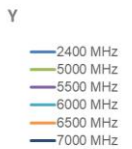
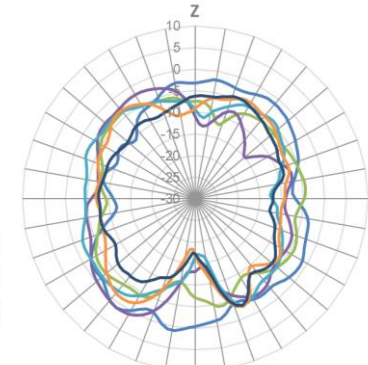

Left Port

XY Plane

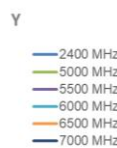
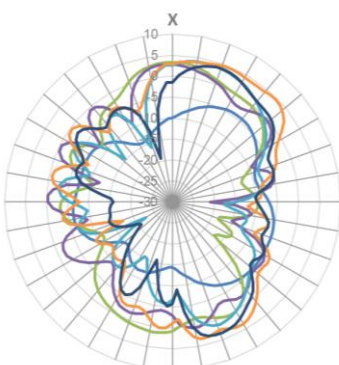

XZ Plane

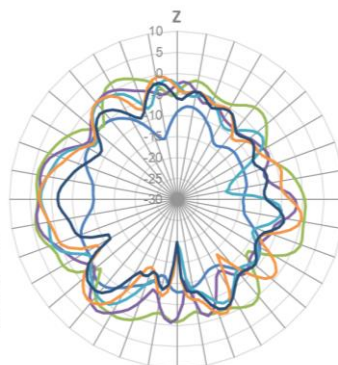

YZ Plane

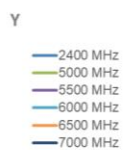
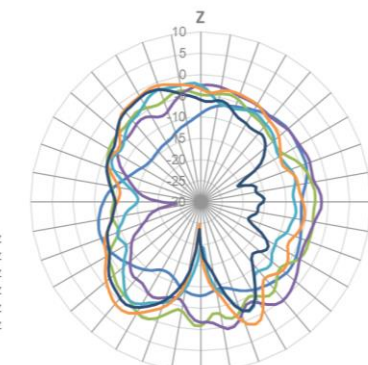

5. Mechanical Drawing (Units: mm)

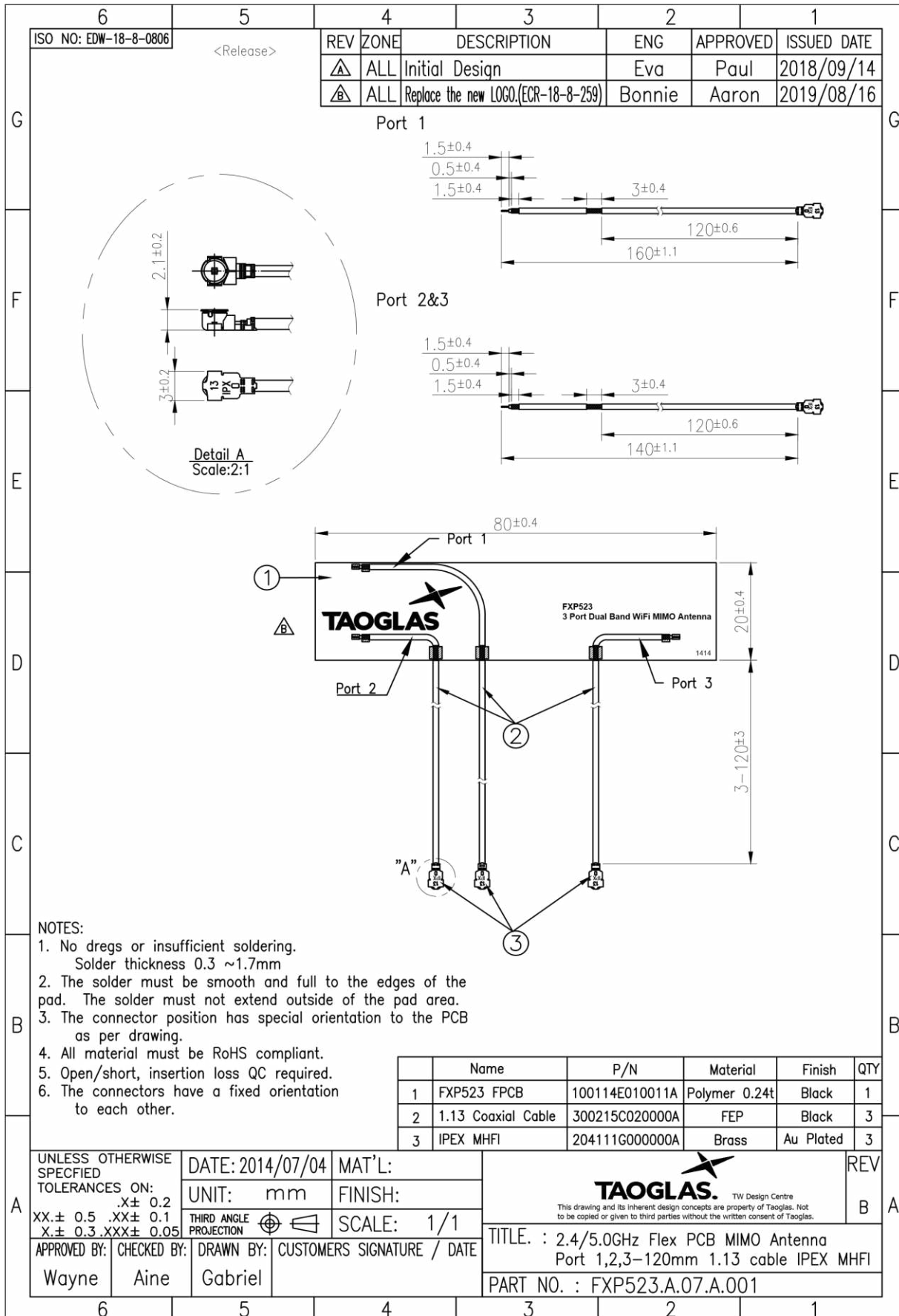

6. Packaging

10 pcs per Small PE Bag

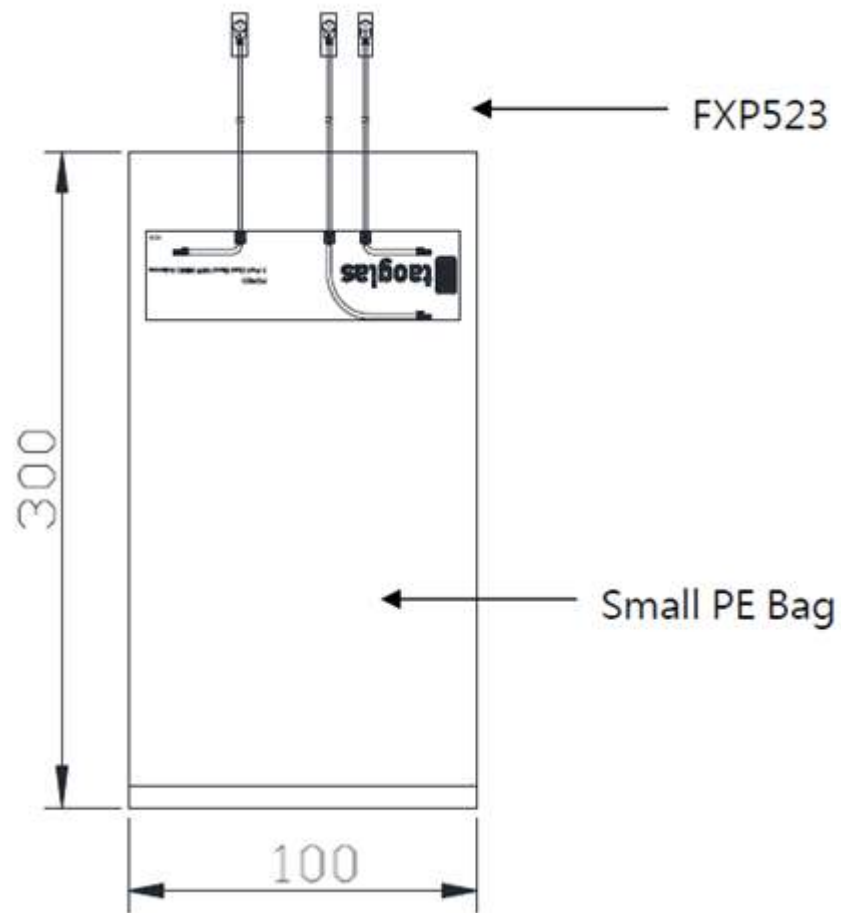

Changelog for the datasheet

SPE-14-8-107 – FXP523.A.07.A.001

Revision: E (Current Version)

Date:	2022-04-26
Changes:	Updated product image
Changes Made by:	Jack Conroy

Previous Revisions

Revision: D

Date:	2020-07-03
Changes:	Updated to include Wi-Fi 6
Changes Made by:	Jack Conroy

Revision: C

Date:	2015-08-14
Changes:	Amended Cable Length
Changes Made by:	Aine Doyle

Revision: B

Date:	2015-01-14
Changes:	Added Note on Intro
Changes Made by:	Aine Doyle

Revision: A (Original First Release)

Date:	2014-10-21
Notes:	
Author:	Technical Writer



TAOGLAS®

www.taoglas.com

