

TOP VIEW

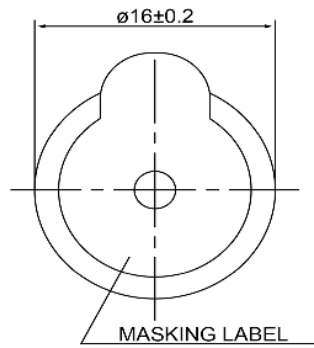

SIDE VIEW

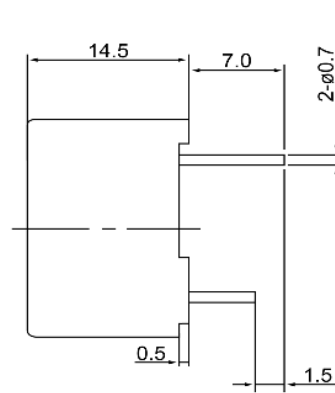

BOTTOM VIEW

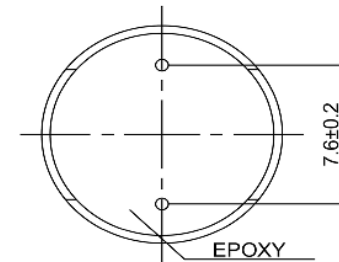

Specifications			Notes	Revision History						
Description	Value	Unit		Version	Description		Date	Approved		
Technology	Electro-Mechanical		1) All dimensions are in mm unless otherwise noted 2) All parts meet RoHS	1	Released from Engineering		10/21/2013	J.S		
Resonant Frequency	2,048	(Hz)								
Rated Voltage	12	(V)								
SPL @ 10cm	85	(dBA)								
Coil Resistance	115	(ohm)								
Mount Type	Thru Hole									
Voltage Range	8 ~ 16	(V)								
Max Rated Current	40	(mA)								
Housing Material	NORYL									
Operating Temperature	-30 ~ +70	°C								
Storage Temperature	-40 ~ +85	°C								
Weight	7	(g)								
 <b>DB UNLIMITED</b>			<b>Electro-Mechanical Transducer</b>			<b>TE162012-5</b>				

Additional considerations can be found at [www.dbunlimitedco.com/technical-articles](http://www.dbunlimitedco.com/technical-articles).