

Am2614

Quad Single-Ended Line Driver

Distinctive Characteristics

- Quad single-ended driver for multi-channel common ground operation
- Single 5V power supply
- DTL, TTL compatible
- Short-circuit protected outputs
- Capable of driving 50Ω terminated transmission lines
- 100% reliability assurance testing in compliance with MIL-STD-883

FUNCTIONAL DESCRIPTION

The Am2614 is a DTL, TTL compatible line driver operating off a single 5V supply. The Am2614 is a quad inverting driver with two separate inputs and one common-strobe input for each pair of drivers. The device has active pull-up outputs for high-speed and HIGH capacitance drive. The Am2614 is ideal for single-ended transmission line driving, or as a high-speed, high-fan-out driver for semiconductor memory decoding, buffering, clock driving and general logic use.

The Am2614 has short circuit protected active pull-ups, and incorporates input clamp diodes to reduce the effect of line transients, and also is capable of driving 50Ω terminated transmission lines.

LOGIC DIAGRAM

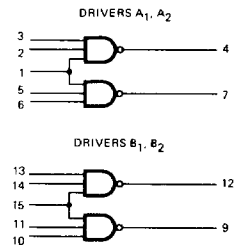

V_{CC} = Pin 16
GND = Pin 8

LIC-391

CIRCUIT DIAGRAM

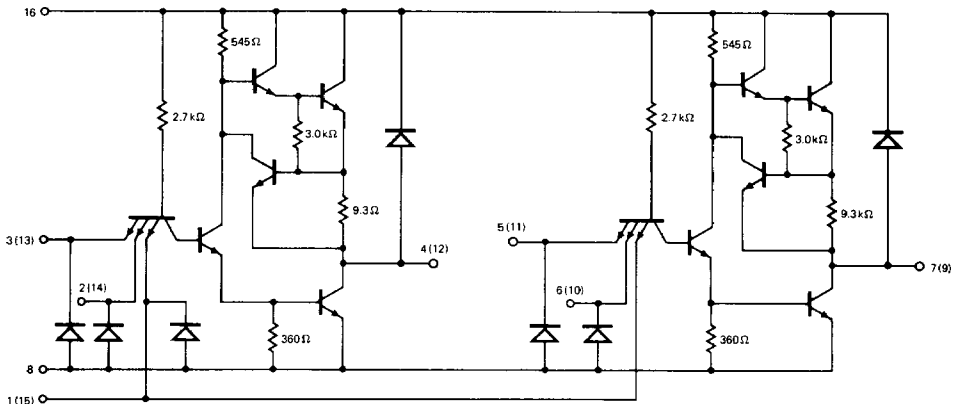

LIC-392

ORDERING INFORMATION

Package Type	Temperature Range	Order Number
Hermetic DIP	-55°C to +125°C	AM2614DM
Flat Pak	-55°C to +125°C	AM2614FM
Dice	-55°C to +125°C	AM2614XM
Hermetic DIP	0°C to +70°C	AM2614DC
Molded DIP	0°C to +70°C	AM2614PC
Dice	0°C to +70°C	AM2614XC

CONNECTION DIAGRAM Top View

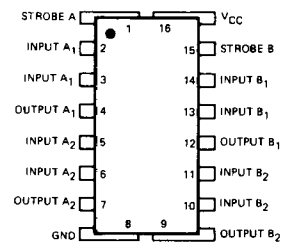

Note: Pin 1 is marked for orientation.

LIC-393

MAXIMUM RATINGS (Above which the useful life may be impaired)

Storage Temperature	-65°C to +150°C
Temperature (Ambient) Under Bias	-55°C to +125°C
Supply Voltage to Ground Potential (Pin 16 to Pin 8) Continuous	-0.5 V to +7 V
DC Voltage Applied to Outputs for HIGH Output State	-0.5 V to +V _{CC} max
DC Input Voltage	-0.5 V to +5.5 V
Output Current, Into Outputs	mA
DC Input Current	Note 1

ELECTRICAL CHARACTERISTICS

The following conditions apply unless otherwise noted:

Am2614XM (MIL)	T _A = -55°C to +125°C	V _{CC} MIN. = 4.50V	V _{CC} MAX. = 5.50V
Am2614XC (COM'L)	T _A = 0°C to +70°C	V _{CC} MIN. = 4.75V	V _{CC} MAX. = 5.25V

DC Characteristics (Note 2)

Parameters	Description	Test Conditions	T _A MIN.		LIMITS +25°C			T _A MAX.		Units	
			Min.	Max.	Min.	Typ.	Max.	Min.	Max.		
V _{OH}	Output HIGH Voltage	V _{CC} = MIN., I _{OH} = -10mA	2.4		2.4	3.2		2.4		Volts	
V _{OL}	Output LOW Voltage	V _{CC} = MIN., I _{OL} = 40mA	MIL	0.4		0.2	0.4		0.4	Volts	
			COM'L	0.45		0.2	0.45		0.45		
V _{IH}	Input HIGH Voltage	V _{CC} = MIN.	MIL	2.0		1.7	1.5		1.4	Volts	
			COM'L	1.9		1.8	1.5		1.6		
V _{IL}	Input LOW Voltage	V _{CC} = MAX.	MIL		0.8		1.3	0.9		0.8	Volts
			COM'L		0.85		1.3	0.85		0.85	
I _F	Input Load Current	V _{CC} = MAX.								mA	
		V _F = 0.4V, MIL									
		V _F = 0.45V, COM'L		-2.4		-1.65	-2.4		-2.4		
I _R	Reverse Input Current	V _{CC} = MAX., V _R = 4.5V		90			90		90	μA	
I _{SC}	Short Circuit Current	V _{CC} = MAX., V _O = 0V			-40	-90	-120			mA	
I _{PD}	Power Supply Current	V _{CC} = MAX., Inputs = 0V		48.7		33	48.7		48.7		
			COM'L				46	70			
			MIL				46	65.7			
I _{CEX}	Reverse Output Current	V _{CC} = MAX.	V _{CEX} = 5.5V, MIL	100		10	100		200	μA	
			V _{CEX} = 5.25V, COM'L	100		10	100		200		
V _{OLC}	Output Low Clamp Voltage	V _{CC} = MAX., I _{OLC} = -40mA				-0.8	-1.5			Volts	
V _{IC}	Input Clamp Voltage	V _{CC} = MIN., I _{IC} = -12mA				-1.0	-1.5			Volts	

Switching Characteristics (T_A = 25°C unless otherwise specified)

Parameters	Description	Test Conditions	Am2614XM			Am2614XC			Units
			Min.	Typ.	Max.	Min.	Typ.	Max.	
t _{pd+}	Turn Off Delay	V _{CC} = 5.0V, C _L = 30pF, V _M = 1.5V, Refer to Fig. 92		8	12		8	15	ns
t _{pd-}	Turn On Delay			7	10		7	12	ns

Notes: 1. Maximum current defined by DC input voltage.

2. For conditions shown as MIN. or MAX., use the appropriate value specified under Electrical Characteristics for the applicable device type or grade.

TYPICAL ELECTRICAL CHARACTERISTICS

Output Low Current Versus Output Low Voltage

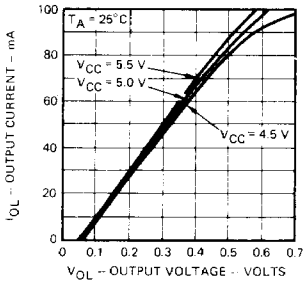

Output High Current Versus Output High Voltage

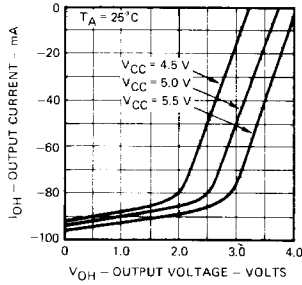

Logic Levels Versus Ambient Temperature

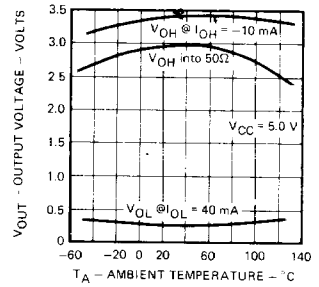

Supply Current Versus Supply Voltage

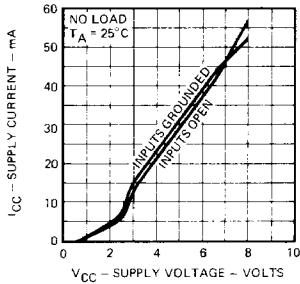

Supply Current Versus Temperature

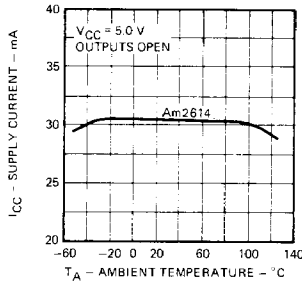

Supply Current Versus Operating Frequency

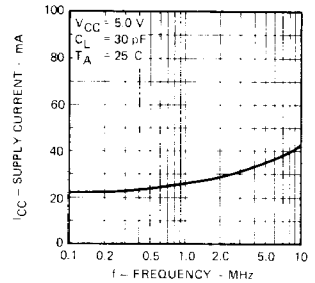

Propagation Delay Time Versus Temperature

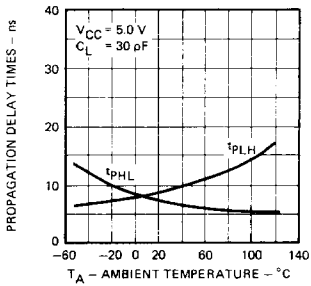

Transfer Characteristics Versus Temperature

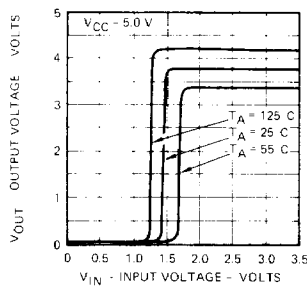

Transfer Characteristics Versus Supply Voltage

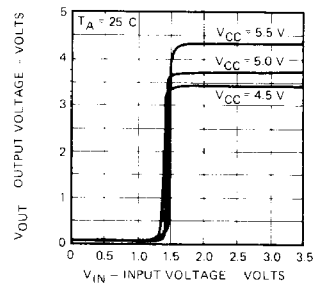

USER NOTES

SINGLE ENDED LINES. The Am2614 quad line driver and the Am2615 dual differential amplifier allow data to be transmitted with only a single data wire per channel and a common ground for typically 8 data wires. This single-ended mode of interconnection offers considerable savings in integrated circuit packages required and effectively halves the number of interconnections as compared to a balanced differential system. The method still gives $\pm 15V$ common mode rejection and DC noise margin of interconnected TTL logic. The common ground wire should be twisted in with the data wires so that any injected noise is common to all wires. If a multiwire cable with screen is used one of the wires is used as the common ground line, and the screen is tied to ground at the driving end only.

MATCHING. Transmission lines can be matched in a number of ways. The most widely used method is to terminate the line at the receiving end in its characteristic impedance. This impedance is connected across the input terminals of the receiver. A 130Ω resistor is included at the + input of each receiver for matching twisted pairs and this resistor, or if the characteristic impedance is not 130Ω , a discrete resistor is connected between the two receiver inputs. This method of

matching causes a DC component in the signal. Power is dissipated in the resistor and the signal is attenuated. The DC component can be effectively removed by connecting a large capacitor in series with the terminating resistor.

The transmission line can also be terminated through the receiver power supply by placing equal value resistors from the + input of the receiver to V_{CC} and from the - input to ground. This method again has the disadvantage that a DC signal component exists, attenuation occurs, and power is dissipated in the terminating resistors but it does allow multiplexed operation in the balanced differential mode.

An alternate method of matching at the receiver is to back match at the driver. A resistor is placed in series with the line so that the signal from the driver which is reflected at the high input impedance of the receiver is absorbed at the driver. This method does not have a DC component and therefore no attenuation occurs and power is not dissipated in the resistor. For balanced differential driving a resistor is required in series with each line. The table below shows the value of each matching resistor required for lines of different characteristic impedance.

TYPICAL DC CHARACTERISTICS FOR MATCHING TO TRANSMISSION LINE

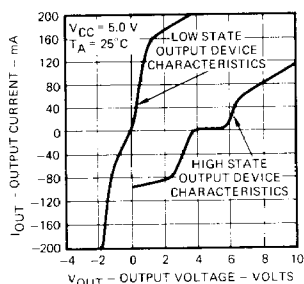

LIC-395

BACK MATCHING TABLE

Z_0	R_M (ohms)
	SINGLE ENDED
50	24
75	51
92	68
100	75
130	110
300	280
600	580

LOADING RULES

Input/Output	Pin No.'s	Input Unit Load	Fanout	
			Output HIGH	Output LOW
Strobe A	1	3	—	—
Input A ₁	2	1.5	—	—
Input A ₁	3	1.5	—	—
Output A ₁	4	—	166	25
Input A ₂	5	1.5	—	—
Input A ₂	6	1.5	—	—
Output A ₂	7	—	166	25
GND	8	—	—	—
Output B ₂	9	—	166	25
Input B ₂	10	1.5	—	—
Input B ₂	11	1.5	—	—
Output B ₂	12	—	166	25
Input B ₁	13	1.5	—	—
Input B ₁	14	1.5	—	—
Strobe B	15	3	—	—
V_{CC}	16	—	—	—

APPLICATIONS

Single-Ended Back-Matched Operation
With Common Ground

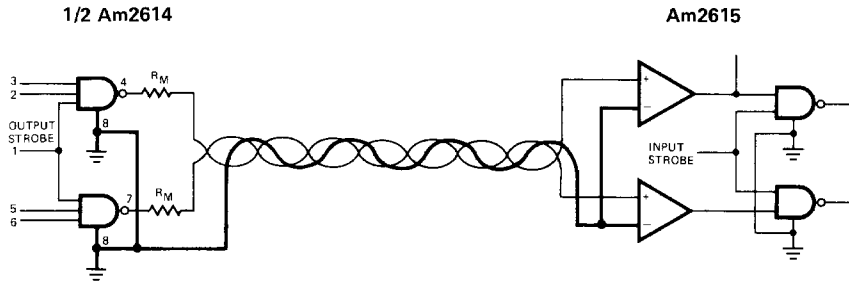

LIC-396

SWITCHING CIRCUITS AND WAVEFORMS

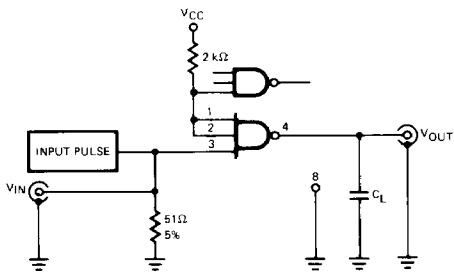

LIC-397

INPUT PULSE
Frequency = 500 kHz
Amplitude = $3.0 \pm 0.1\text{ V}$
Pulse Width = $110 \pm 10\text{ ns}$
 $t_r = t_f \leq 5.0\text{ ns}$

LIC-398

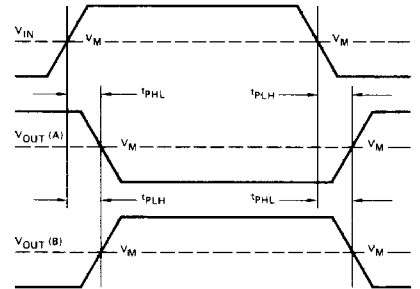

Figure 1.