

3 LIGHT PIPE OPTION  
P/N 171224-\*\*30

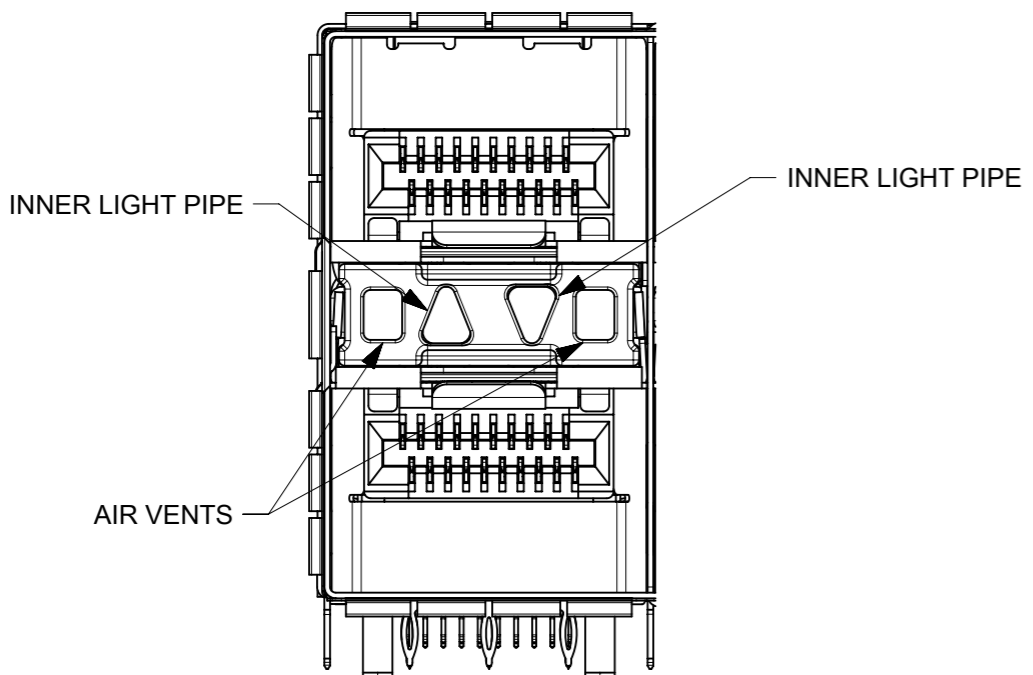

INNER LIGHT PIPE OPTION  
P/N 171224-\*\*31

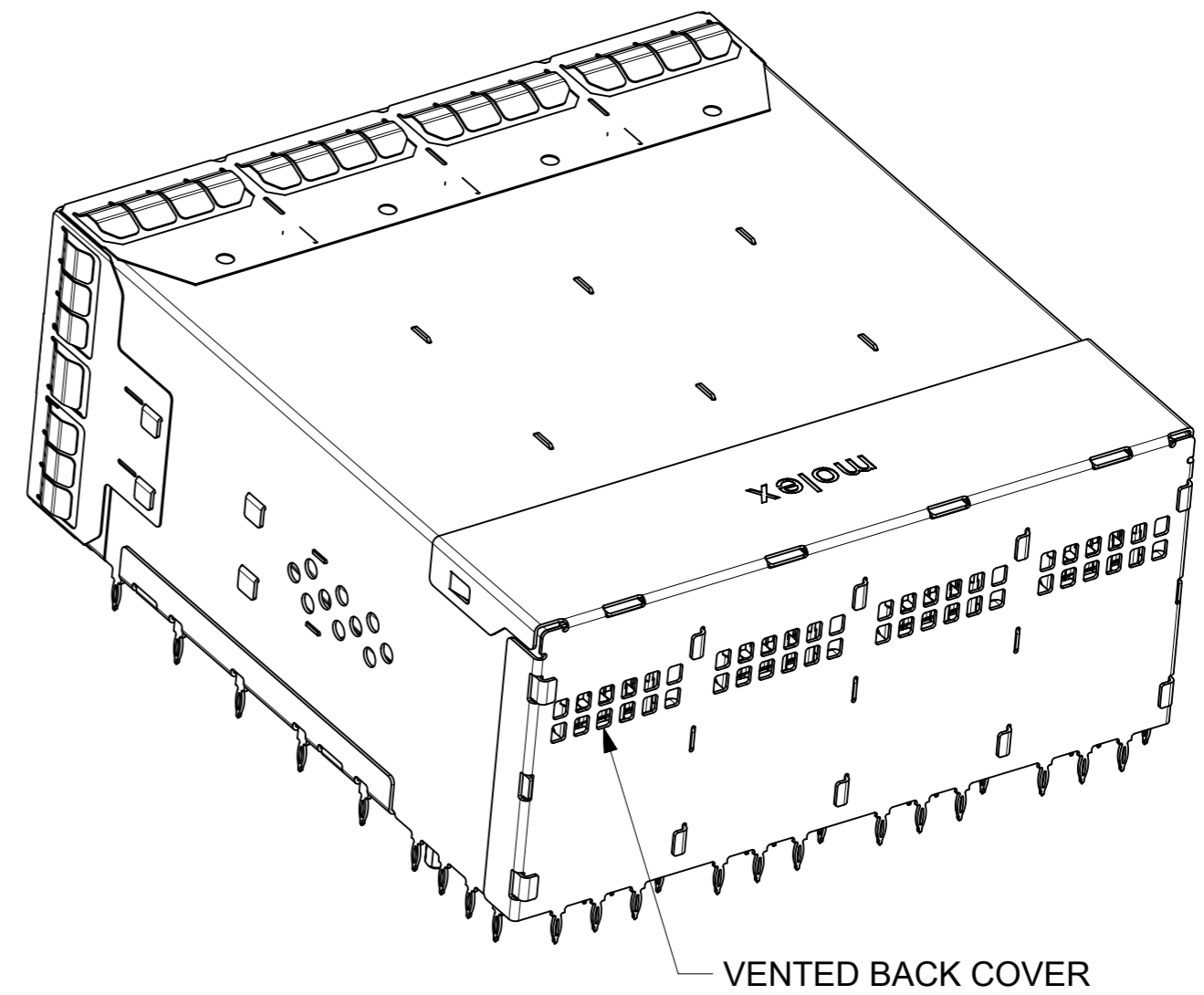

THIS DRAWING CONTAINS INFORMATION THAT IS PROPRIETARY TO MOLEX ELECTRONIC TECHNOLOGIES, LLC AND SHOULD NOT BE USED WITHOUT WRITTEN PERMISSION											
SYMBOLS	DIMENSION UNITS	SCALE	CURRENT REV DESC: SEE REVISION HISTORY								
	mm	2:1	<b>molex</b> ZSFP+ STACKED CONNECTOR VENTED W/ LIGHT PIPES PRODUCT CUSTOMER DRAWING								
GENERAL TOLERANCES (UNLESS SPECIFIED)											
▽ = 0	ANGULAR TOL	± 0.5°	INITIAL REVISION:								
▽ = 0	4 PLACES	±	DRWN: JKACHLIC 2014/03/18								
▽ = 0	3 PLACES	±	APPR: MBANAKIS 2014/03/21								
▽ = 0	2 PLACES	± 0.13	DOCUMENT NUMBER								
▽ = 0	1 PLACE	± 0.25	SD-171224-4300								
▽ = 0	0 PLACES	±	DOC TYPE DOC PART REVISION								
□ = 0	DRAFT WHERE APPLICABLE MUST REMAIN WITHIN DIMENSIONS		THIRD ANGLE PROJECTION			DRAWING		SERIES		MATERIAL NUMBER	
▽ = 0			A3-SIZE			171224		CUSTOMER		SEE TABLE	
								GENERAL MARKET		SHEET NUMBER	
										2 OF 5	





10

9

8

7

6

5

4

3

2

1

F

F

E

E

D

D

C

C









B

B

A

A

REVISION HISTORY		
DATE	REV	DESCRIPTION
2019/08/23	D1	1.ADDED REVISION HISTORY. 2.UPDATE NOTE FOR KEEP-OUT ZONE IN SHEET3. 3.ADDED DIMENSION OF SHORT SIGNAL PIN IN SHEET1.

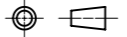
SYMBOLS	THIS DRAWING CONTAINS INFORMATION THAT IS PROPRIETARY TO MOLEX ELECTRONIC TECHNOLOGIES, LLC AND SHOULD NOT BE USED WITHOUT WRITTEN PERMISSION											
	 = 0	DIMENSION UNITS	SCALE	CURRENT REV DESC: SEE REVISION HISTORY							<b>molex</b>	
	 = 0	mm	1:1	GENERAL TOLERANCES (UNLESS SPECIFIED)								
	 = 0	ANGULAR TOL ± 0.5°		EC NO: 616026							ZSFP+ STACKED CONNECTOR VENTED W/ LIGHT PIPES	
	 = 0	4 PLACES ±	DRWN: CWANG67 2019/04/23							PRODUCT CUSTOMER DRAWING		
	 = 0	3 PLACES ±	CHK'D: RNELSON 2019/09/04							DOCUMENT NUMBER		
	 = 0	2 PLACES ± 0.13	APPR: RNELSON 2019/09/04							SD-171224-4300		
	 = 0	1 PLACE ± 0.25	INITIAL REVISION:							DOC TYPE		
	 = 0	0 PLACES ±	DRWN: JKACHLIC 2014/03/18							PSD		
	 = 0	DRAFT WHERE APPLICABLE MUST REMAIN WITHIN DIMENSIONS		THIRD ANGLE PROJECTION		DRAWING	SERIES	MATERIAL NUMBER	CUSTOMER	DOC PART	REVISION	
= 0					A3-SIZE	171224		GENERAL MARKET	001	D1		
										SHEET NUMBER		
										5 OF 5		

DOCUMENT STATUS	P1	RELEASE DATE	2019/09/04	07:26:35
-----------------	----	--------------	------------	----------

9

8

7

6

5

4

3

2

1

10

FORMAT: mm 1:1 A3  
REVISION: 11  
DATE: 2018/01/11