



Generation Y Connector System

TE Internal #: 2035334-3

Automotive Terminals, Receptacle, Mating Tab Width .64 mm [.025 in], Tab Thickness .64 mm [.025 in], Generation Y Connector System

[View on TE.com >](#)

Terminals & Splices > Automotive Terminals

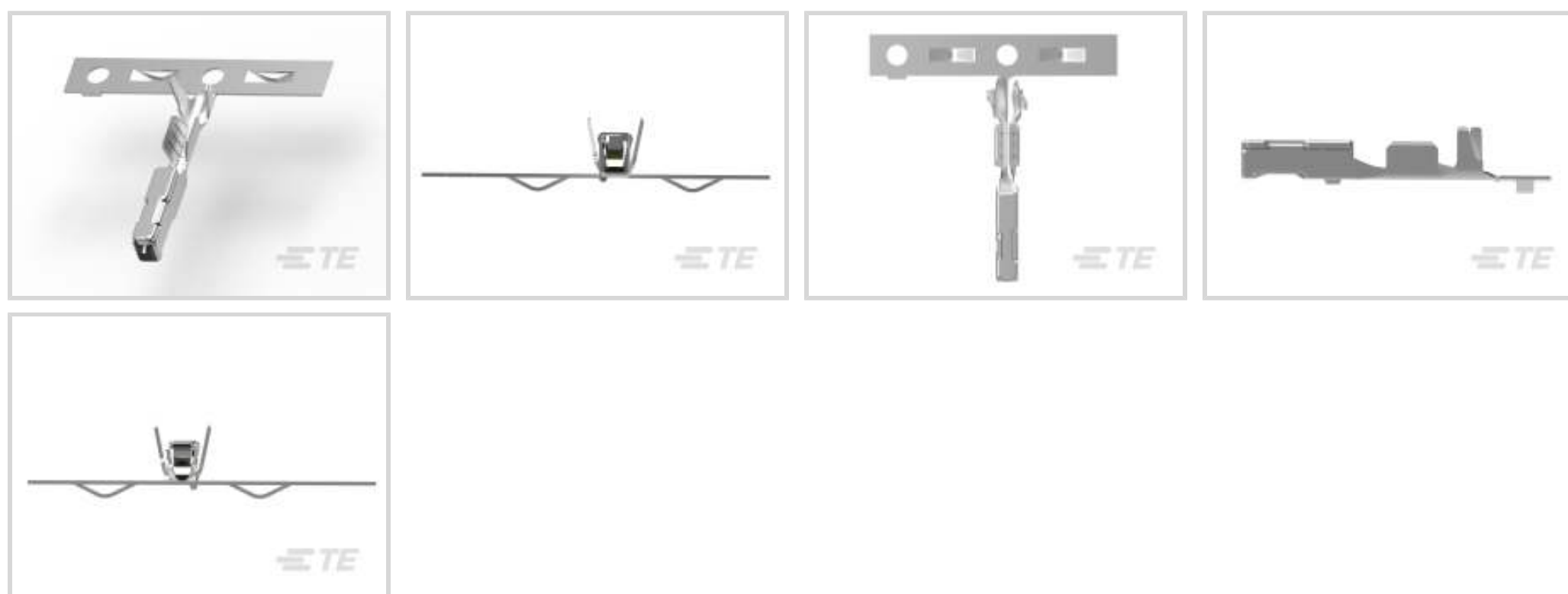

Terminal Type: **Receptacle**

Mating Tab Width: **.64 mm [.025 in]**

Mating Tab Thickness: **.64 mm [.025 in]**

Terminal Transmits: **0 – 24 A (Low Power)**

Wire Size: **22 – 20 AWG**

Features

Product Type Features

Sealable	Yes
Primary Locking Feature	Clean Body

Body Features

Terminal Seal Type	Family Seal
--------------------	-------------

Contact Features

Contact Size	.64mm
Contact Fabrication	Stamped & Formed
Typical Current Rating	9 A
Crimp Type	F-Crimp
Terminal Type	Receptacle
Mating Tab Width	.64 mm[.025 in]
Mating Tab Thickness	.64 mm[.025 in]
Interface Plating	Tin (Sn)

Termination Features

--	--



Termination Method to Wire & Cable	Crimp
Product Terminates To	Wire

Dimensions

Compatible Insulation Diameter Range	1.5 – 1.85 mm [.059 – .073 in]
Wire Size	.35 – .5 mm ²
Wire Size Search	20 AWG, 21 AWG, 22 AWG

Usage Conditions

Insulation Option	Uninsulated
Operating Temperature (Max)	80 °C, 85 °C, 90 °C, 100 °C [176 °F][185 °F] [194 °F][212 °F]
Operating Temperature Range	-40 – 100 °C [-40 – 212 °F]

Operation/Application

Compatible With Wire Base Material	Copper
------------------------------------	--------

Industry Standards

Agency/Standard	SAE/USCAR-2, USCAR-21
-----------------	-----------------------

Packaging Features

Packaging Quantity	7500
Packaging Method	Package

Other

Terminal Transmits	0 – 24 A (Low Power)
--------------------	----------------------

Product Compliance

For compliance documentation, visit the product page on [TE.com](https://www.te.com)>

EU RoHS Directive 2011/65/EU	Compliant
EU ELV Directive 2000/53/EC	Compliant
China RoHS 2 Directive MIIT Order No 32, 2016	No Restricted Materials Above Threshold
EU REACH Regulation (EC) No. 1907/2006	Current ECHA Candidate List: JUNE 2023 (235) Candidate List Declared Against: JAN 2023 (233) Does not contain REACH SVHC
Halogen Content	Low Halogen - Br, Cl, F, I < 900 ppm per homogenous material. Also BFR/CFR/PVC Free
Solder Process Capability	Not applicable for solder process capability

Product Compliance Disclaimer

This information is provided based on reasonable inquiry of our suppliers and represents our current actual knowledge based on the information they provided. This information is subject to change. The part numbers that TE has identified as EU RoHS compliant have a maximum concentration of 0.1% by weight in homogenous materials for lead, hexavalent chromium, mercury, PBB, PBDE, DBP, BBP, DEHP, DIBP, and 0.01% for cadmium, or qualify for an exemption to these limits as defined in the Annexes of Directive 2011/65/EU (RoHS2). Finished electrical and electronic equipment products will be CE marked as required by Directive 2011/65/EU. Components may not be CE marked. Additionally, the part numbers that TE has identified as EU ELV compliant have a maximum concentration of 0.1% by weight in homogenous materials for lead, hexavalent chromium, and mercury, and 0.01% for cadmium, or qualify for an exemption to these limits as defined in the Annexes of Directive 2000/53/EC (ELV). Regarding the REACH Regulation, the information TE provides on SVHC in articles for this part number is based on the latest European Chemicals Agency (ECHA) 'Guidance on requirements for substances in articles' posted at this URL: <https://echa.europa.eu/guidance-documents/guidance-on-reach>

Compatible Parts



TE Part # 2305570-1
Strip Terminal Cutter-Side Feed-No Crimp



TE Part # 2151725-1
OCEAN_2.0_APPLICATOR-S-053F061O



KIT
TE Part # 7-2151725-7
OCEAN_2.0_SPARE_PART_KIT-053F061O



TE Part # 2288274-1
24P HYBRID 0.64/2.8 PLUG ASSY, A KEY



TE Part # 2063291-1
PRO-C HT & DIE GEN Y



TE Part # 1-2208021-1
22POS,0.64 GENER. Y,REC HSG,ASSY



TE Part # 1-2208021-2
22POS,0.64 GENER. Y,REC HSG,ASSY



TE Part # 1-2208021-3
22POS,0.64 GENER. Y,REC HSG,ASSY



TE Part # 1-2208021-4
22POS,0.64 GENER. Y,REC HSG,ASSY



TE Part # 1-2287336-1
72POS,MIXED,REC HSG,ASSY



TE Part # 1-2287336-2
72POS,MIXED,REC HSG,ASSY



TE Part # 2-2151725-1
OCEAN_2.0_APPLICATOR-S-053F061O



TE Part # 2-2151725-2
OCEAN_2.0_APPLICATOR-S-053F061O



TE Part # 2151725-2
OCEAN_2.0_APPLICATOR-S-053F061O



TE Part # 2287277-1
50POS,MIXED,REC HSG,ASSY



TE Part # 2288274-2
24P HYBRID 0.64/2.8 PLUG ASSY, B KEY



TE Part # 2295154-1
22POS,0.64 GENER. Y,REC HSG,ASSY,SLD



TE Part # 2295154-4
22POS,0.64 GENER. Y,REC HSG,ASSY,SLD



TE Part # 7-2151725-1
OCEAN_2.0_APPLICATOR-S-053F061O



TE Part # 7-2151725-2
OCEAN_2.0_APPLICATOR-S-053F061O

Also in the Series | Generation Y Connector System



Automotive Connector Caps & Covers (17)



Automotive Housings(155)



Automotive Terminals(39)



Insertion & Extraction Tools(1)



PCB Headers & Receptacles(15)

Customers Also Bought



TE Part #1379913-1
20POS MQS TAB



TE Part #1-1355877-1
AMP MCP, RECEPTACLE AND TAB



TE Part #1924968-3
Contact, male 0.64, 20 to 22 AWG



KIT
TE Part #7-2836042-7
OCEAN_2.0_SPARE_PART_KIT-061F

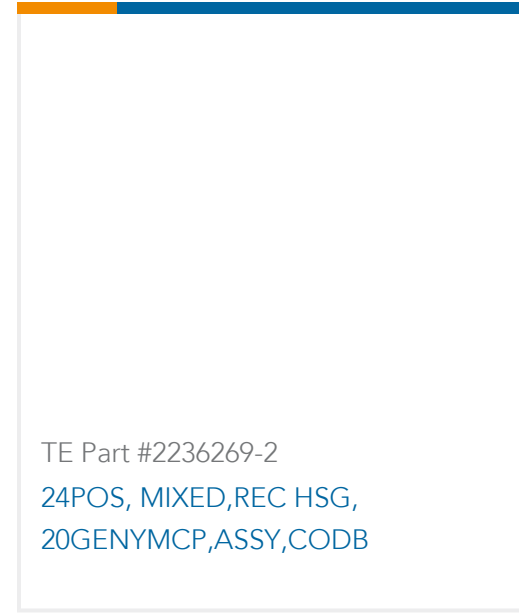
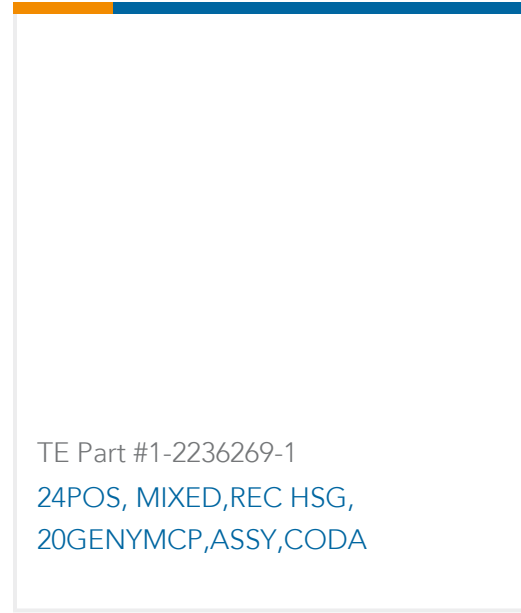

Documents

Product Drawings

[CONTACT,FEMALE0.64, 20 TO 22 AWG](#)

English

CAD Files

[3D PDF](#)

3D

Customer View Model

[ENG_CVM_CVM_2035334-3_D.2d_dxf.zip](#)

English

Customer View Model

[ENG_CVM_CVM_2035334-3_D.3d_igs.zip](#)

English

Customer View Model

[ENG_CVM_CVM_2035334-3_D.3d_stp.zip](#)

English

By downloading the CAD file I accept and agree to the [Terms and Conditions](#) of use.

Product Specifications

[Application Specification](#)

English