

# HRXL-MaxSonar® - WR™ Series

High Resolution, Precision, IP67 Weather Resistant, Ultrasonic Range Finder

MB7360, MB7363, MB7366, MB7367, MB7368, MB7369, MB7375  
 MB7380, MB7383, MB7386, MB7387, MB7388, MB7389, MB7395<sup>8</sup>



The HRXL-MaxSonar-WR sensor line is a cost-effective solution for applications requiring precision range-finding, low-voltage operation, space saving, low-cost, and IP67 rating for weather resistance.

The HRXL-MaxSonar-WR sensor line provides high accuracy and high resolution ultrasonic proximity detection and ranging in air. This sensor line features 1-mm resolution, target-size and operating-voltage compensation for improved accuracy, superior rejection of outside noise sources, internal speed-of-sound temperature compensation and optional external speed-of-sound temperature compensation. The HRXL-MaxSonar-WR/WRC models are available in 1.5-meter, 5-meter, or 10-meter models. This ultrasonic sensor detects objects from 1-mm and ranges to objects from 30-cm\* to maximum range. Objects closer than 30-cm\* are typically reported as 30-cm\*. The interface output formats are pulse width, analog voltage, and digital serial in either RS232 (MB736X/MB7375) or TTL (MB738X/MB7395). Factory calibration is standard. \*For select sensors this distance is 50-cm, refer to pages 4 and 5.

## Precision Ultrasonic Range Sensing

- Range-finding at a fraction of the cost of other precision rangefinders
- Reading-to-reading stability of 1-mm at 1-meter is typical<sup>1</sup>
- Accuracy is factory-matched providing a typical accuracy of 1% or better<sup>1,2</sup>
- Internal temperature compensation is standard and optional external temperature compensation
- Determines range to largest object (MB7368, MB7369, MB7388, MB7389)
- Determines range to first detectable object (MB7360, MB7363, MB7366, MB7367, MB7375, MB7380, MB7383, MB7386, MB7387, MB7395)
- Excellent clutter rejection
- Additional chemical resistance available<sup>6</sup>

## Very Low Power Requirements

- Fast first reading after power-up eases battery requirements
- Wide, low supply voltage of 2.7V<sup>9</sup> to 5.5V requirements eases battery powered design
- Low current draw reduces current drain for battery operation
- Very low-power rangefinder, excellent for multiple sensor or battery based systems

## Easy to Use Component Module

- Gracefully handles other ultrasonic sensors<sup>5</sup>
- Stable and reliable range readings and excellent noise rejection make the sensor easy to use for most users
- Easy to use interface with distance provided in a variety of outputs
- Target size compensation provides greater consistency and accuracy
- Sensor automatically handles acoustic noise<sup>2,4</sup>
- Calibrated sensor eliminates most sensor to sensor variations

## Applications & Uses

- Tank level measurement (MB7369 or MB7389)
- Weather station monitoring
- Bin level measurement
- Proximity zone detection
- People detection
- Robot ranging sensor
- Long range object detection
- Environments with acoustic and electrical noise
- Height monitors
- Auto sizing
- Box dimensions
- Automated factory systems

### Notes:

- <sup>1</sup> Refer to section that compares WR to alternative housings on page 4
- <sup>2</sup> Users are encouraged to evaluate the sensor performance in their application
- <sup>3</sup> Reference pages 10-11 for part specific timing information
- <sup>4</sup> by design
- <sup>5</sup> See page 7 for multi-sensor operation
- <sup>6</sup> F-Option provides additional protection from hazardous chemical environments
- <sup>7</sup> Please reference page 12 & 13 for minimum operating voltage verses temperature information
- <sup>8</sup> Please reference page 25 for part number key
- <sup>9</sup> Operation below 5V may cause reduced performance in some stated specifications

## Close Range Operation

Applications requiring 100% reading-to-reading reliability should not use MaxSonar sensors at a distance closer than 50-cm. Although most users find MaxSonar sensors to work reliably from 0 to 50-cm for detecting objects in many applications, MaxBotix® Inc. does not guarantee operational reliability for objects closer than the minimum reported distance. Because of ultrasonic physics, these sensors are unable to achieve 100% reliability at close distances.

## Warning: Personal Safety Applications

We do not recommend or endorse this product be used as a component in any personal safety applications. This product is not designed, intended or authorized for such use. These sensors and controls do not include the self-checking redundant circuitry needed for such use. Such unauthorized use may create a failure of the MaxBotix® Inc. product which may result in personal injury or death. MaxBotix® Inc. will not be held liable for unauthorized use of this component.

## General Characteristics

- Low cost ultrasonic rangefinder
- Detection out to 1.5-meters, 5-meters, or 10-meters
- Resolution of 1-mm
- Distance sensor from 30-cm to 1.5-meters, 30-cm to 5-meters, or 50-cm to 10-meters based on model
- Excellent <sup>2</sup> Mean Time Between Failure (MTBF)

- Triggered operation yields real-time range data
- Free run operation with superior noise rejection <sup>3</sup>
- Operating temperature range from -40°C to +65°C <sup>7</sup>
- Operating voltage of 2.7V to 5.5V<sup>7</sup>
- Nominal current draw of 2.3mA (peak ~49mA) at 3.3V, and 3.1mA (peak ~98mA) at 5V
- IP67 Rated

## Range Outputs

- Pulse width, 1uS/mm resolution
- Analog Voltage, 5-mm resolution (5-meter sensors)
- Analog Voltage, 10-mm resolution (1.5 and 10-meter sensors)
- Serial, 1-mm resolution
- Available in RS232 (MB736X and MB7375) or TTL (MB738X and MB7395)

## HRXL-MaxSonar-WR Pin Out

**Pin 1- Temperature Sensor Connection:** Leave this pin unconnected if an external temperature sensor is not used. For best accuracy, this pin is optionally connected to the HR-MaxTemp temperature sensor. Some additional information for the temperature sensor can be found on page 12 of the datasheet.

**Pin 2- Pulse Width Output:** This pin outputs a pulse width representation of the distance with a scale factor of 1uS per mm. The pulse width output is sent with a value within 0.5% of the serial output.

**Pin 3- Analog Voltage Output:** This pin outputs a single ended analog voltage scaled representation of the distance. This output is referenced to the sensor ground and Vcc. After the ~50mS power up initialization, the voltage on this pin is set to a low voltage. Once the sensor has completed a range reading the voltage on this pin is set to the voltage corresponding to the latest measured distance.

The 5-meter sensors (MB7360, MB7369, MB7380 and MB7389) use a scale factor of (Vcc/5120) per 1-mm. The distance is output with a 5-mm resolution. The analog voltage output is typically within ±5-mm of the serial output.

The 1.5-meter sensors (MB7375 and MB7395) and 10-meter sensors (MB7363, MB7366, MB7368, MB7383, MB7386, and MB7388) use a scale factor of (Vcc/10240) per 1-mm. The distance is output with a 10-mm resolution. The analog voltage output is typically within ±10-mm of the serial output.

Using a 10-bit analog to digital converter with the 5-meter sensors, one can read the analog voltage counts (i.e. 0 to 1023) directly and just multiply the number of counts in the value by 5 to yield the range in mm. For example, a converted value of 60 corresponds to 300-mm (where 60 x 5 = 300), and 1000 counts corresponds to 5,000-mm (where 1000 x 5 = 5,000-mm).

Using a 10-bit analog to digital converter with the 10-meter sensors, one can read the analog voltage counts (i.e. 0 to 1023) directly and just multiply the number of counts in the value by 10 to yield the range in mm. For example, 30 counts corresponds to 300-mm (where 30 x 10 = 300), and 1000 counts corresponds to 10,000-mm (where 1000 x 10 = 10,000-mm).

**Pin 4- Ranging Start/Stop:** This pin is internally pulled high. If this pin is left unconnected or held high, the sensor will continually measure and output the range data. If held low, the HRXL-MaxSonar-WR will stop ranging. Bring high for 20uS or longer to command a range reading.

**Filtered Range Data:** When pin 4 is left high on the sensors, the sensors will continue to range. The data that is output includes a filter for increased accuracy. The sensors will output the range based on recent range information. The filter does not affect the speed at which data is made available to the user but instead allows for more consistent range information to be presented. For sensor specific timing and filter information refer to pages 10 and 11.

**Real-time Range Data:** When pin 4 is low and then brought high, the sensor will operate in real time and the first reading output will be the range measured from this first commanded range reading. When the sensor tracks that the RX pin is low after each range reading, and then the RX pin is brought high, unfiltered real time range information can be obtained. For timing information please refer to pages 10 and 11.

**Pin 5-Serial Output:** The MB736X/MB7375 sensors have an RS232 data format (with 0V to Vcc levels) and the MB738X/MB7395 sensors have a TTL outputs. The output is an ASCII capital "R", followed by four ASCII character digits representing the range in millimeters, followed by a carriage return (ASCII 13). The maximum range reported is 4999 mm (5-meter models) or 9998 mm (10-meter models). A range value of 5000 or 9999 corresponds to no target being detected in the field of view.

The serial data format is 9600 baud, 8 data bits, no parity, with one stop bit (9600-8-N-1).

Because the data is presented in a binary data format, the serial output is most accurate .

On power up the sensor will send serial data about the sensor. [View an example here.](#)

**V+ Pin 6 - Positive Power, Vcc:** The sensor operates on voltages from 2.7V - 5.5V DC. For best operation, the sensor requires that the DC power be free from electrical noise. (For installations with known dirty electrical power, a 100uF capacitor and 10ohm resistor placed at the sensor pins between V+ and GND will typically correct the electrical noise.) Please reference page 12 & 13 for minimum operating voltage verses temperature information.

**GND Pin 7 – Sensor ground pin:** DC return, and circuit common ground.

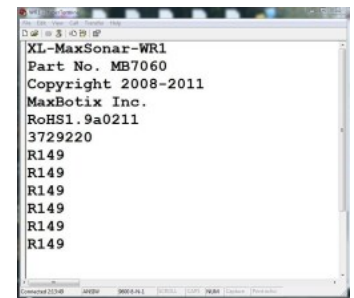

## About Ultrasonic Sensors

The HRXL-MaxSonar-WR ultrasonic sensors are in-air, non-contact object detection and ranging sensors that detect objects within an area. These sensors are not affected by the color or other visual characteristics of the detected object. Ultrasonic sensors use high frequency sound to detect and localize objects in a variety of environments. Ultrasonic sensors measure the time of flight for sound that has been transmitted to and reflected back from nearby objects. Based upon the time of flight, the sensor outputs a range reading.

## Device Comparison

Part Number	Serial Interface	First Detectable target	Most Likely Filter <sup>1</sup>	High Performance HR Filter <sup>2</sup>	Optimized for snow depth	Alternative Packages available	Soft/Small Target Detection <sup>3</sup>	1.5 Meter Range	5 Meter Range	10 Meter Range
MB7360	RS232	Yes		Yes		Yes			Yes	
MB7363	RS232	Yes		Yes			Yes			Yes
MB7366	RS232	Yes		Yes						Yes
MB7368	RS232		Yes	Yes						Yes
MB7369	RS232		Yes	Yes		Yes			Yes	
MB7375	RS232	Yes		Yes		Yes		Yes		
MB7380	TTL	Yes		Yes		Yes			Yes	
MB7383	TTL	Yes		Yes			Yes			Yes
MB7386	TTL	Yes		Yes						Yes
MB7388	TTL		Yes	Yes						Yes
MB7389	TTL		Yes	Yes		Yes			Yes	
MB7395	TTL	Yes		Yes				Yes		

### Notes

<sup>1</sup> Our standard sensors provide the range to the first target they detect. Our most-likely filter allows our sensors to continue looking for larger targets. This way they only give you the range to the target with the largest return of sound as seen by the sensor. Note that while this will often be the largest target in an environment, there are times when small targets will reflect more sound to the sensor than larger targets .

<sup>2</sup> Exceeds the ability of the first generation XL-MaxSonar-WR models MB70###. Also includes target size compensation, internal temperature sensor, external temperature sensor, factory calibration, supply voltage drop compensation, continuous automatic calibration, and side lobe suppression.

<sup>3</sup> Higher gain and other calibration allows better performance to soft targets.

## Auto Calibration

Each time a HRXL-MaxSonar-WR sensor takes a range reading, it calibrates itself. The sensor uses this data to range objects. If the temperature, humidity, or applied voltage changes during operation, the sensor will continue to function normally over the rated temperature range while applying compensation for changes caused by temperature and voltage.

## Target Size Compensation

Most low cost ultrasonic rangefinders will report the range to smaller size targets as farther than the actual distance. In addition, they may also report the range to larger size targets as closer than the actual distance.

The HRXL-MaxSonar-WR sensor line compensates for target size differences. This means that, provided an object is large enough to be detected, the sensor will report the same distance, typically within 1%<sup>1</sup>, regardless of target size<sup>1</sup>. Smaller targets can have additional detection noise that may limit this feature. In addition, targets with small or rounded surfaces may have an apparent distance that is slightly farther, where the distance reported may be a composite of the sensed object(s). Compensation for target size is applied to all range outputs: pulse width, analog voltage, and serial format output by the sensor.

## Supply Voltage Compensation

During power up, the HRXL-MaxSonar-WR sensor line will calibrate itself for changes in supply voltage. Additionally, the sensor will compensate if the supplied voltage gradually changes.

If the average voltage applied to the sensor changes faster than 0.5V per second, it is best to remove and reapply power to the sensor.

For best operation, the sensor requires noise free power . If the sensor is used with noise on the supplied power or ground, the readings may be affected. Typically adding a 100uF capacitor and 10ohm resistor at the sensor between the V+ and GND pins will correct most power related electrical noise issues.

**Notes:** <sup>1</sup> Refer to section that compares WR to WRC on page 4

### Base sensor (MB7360 and MB7380)

The MB7360 and MB7380 are the base model of the HRXL-MaxSonar-WR sensor line. These sensors are recommended for users unsure of which sensor to use in their application. All other sensors in this series are based off of these sensor models. The additional features are mentioned in their respective sections below.

### HRXL-MaxSonar-WRLS (MB7363 and MB7383)

The HRXL-MaxSonar-WRLS sensors are 10 meter sensors with a higher sensitivity than other HRXL-MaxSonar-WR products. This sensor is recommended for applications in which objects do not reflect enough ultrasonic sound, such as people, to be detected. Users are encouraged to test the sensor in their application to verify usability.

### HRXL-MaxSonar-WRL (MB7366, MB7386)

The HRXL-MaxSonar-WRL sensors are the 10-meter version of the HRXL-MaxSonar-WR sensors.

### HRXL-MaxSonar-WRML (MB7368, MB7388)

The HRXL-MaxSonar-WRML sensors are equipped with filtering firmware which allows the sensor to ignore smaller targets and noise, and still report the target that gives the largest acoustic return with a 10-meter maximum range. (The sensor will also reject periodic noise, even noise that has a higher amplitude than the acoustic return from the target.) This provides the flexibility to consistently range larger targets in the presence of clutter and noise. If the largest target is removed, the HRXL-MaxSonar-WRML will switch to the target with the next largest detectable return.

The HRXL-MaxSonar-WRML sensors were designed for applications where users were concerned with ranging the distance to large flat targets (such as in a water tank). This stands in contrast to other HRXL-MaxSonar-WR sensors which will report the distance to the first detectable target.

In general, the HRXL-MaxSonar-WRML will select the largest target from its field of view and report its range. Even so, objects up close may provide significantly greater returns over distant objects. Users are encouraged to test the sensor in their application to verify usability.

When targets are of similar amplitude reflections, preference is given to the closest target.

### HRXL-MaxSonar-WRM (MB7369 and MB7389)

The HRXL-MaxSonar-WRM sensors are the 5-meter version of the HRXL-MaxSonar-WRML sensors.

### HRXL-MaxSonar-WRB (MB7375 and MB7395)

The HRXL-MaxSonar-WRB sensors are the 1.525-meter (5-foot) wide beam versions of HRXL-MaxSonar-WRML sensors.

### About Package Types

The HRXL-MaxSonar-WR sensors are available in a variety of packages for applications with specific mounting requirements. The full horn package provides peak accuracy and sensitivity in this sensor line. It is recommended that testing is completed to ensure that the selected sensor will operate as desired in your application.

Package Types Currently Available
Full Horn – 3/4” NPT straight; back mounted thread
Compact – 3/4” NPT straight; back mounted thread
1”NPS – External thread over full sensor body (1”NPS)
1”BSPP – External thread over full sensor body (1”BSPP)
30mm1.5 – External thread over full sensor body (30mm1.5)
Extended Horn – 3/4” NPT straight; back mounted thread. Enhanced detection of distant and small targets.
<b>All package types have exposed PCB on user end for easy connection. Users desiring a fully enclosed assembly may purchase the “Shielded Cable Attach Option” along with their sensor.</b>



## Performance Changes when Selecting a Non-Full Horn Package

When selecting a HRXL-MaxSonar-WR sensor without the full horn the sensor will experience the following performance changes:

- The sensor will have a wider beam shape for the first meter.
- The sensor may be less accurate by an additional +/- 0.5%.
- The sensor may have a dead zone from 0mm–500mm.
- The sensor may have worse performance to small or soft targets.
- The sensor may experience decreased noise immunity when ranging to small, soft, angled, or distant targets.

## Mechanical Dimensions

### Full Horn

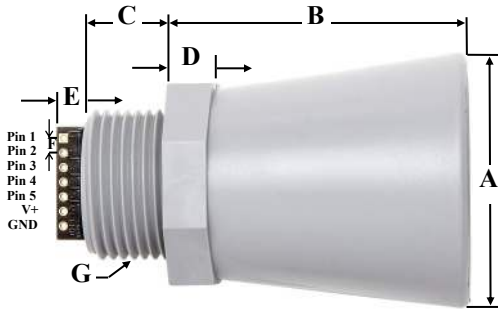

A	1.72" dia.	43.8 mm dia.
B	2.00"	50.7 mm
C	0.58"	14.4 mm
D	0.31"	7.9 mm
E	0.23"	5.8 mm
F	0.1"	2.54 mm
G	3/4"-14 NPS	
H	1.032" dia.	26.2 mm dia.
I	1.37"	34.8 mm
Weight, 1.76 oz., 50 grams		

Values Are Nominal

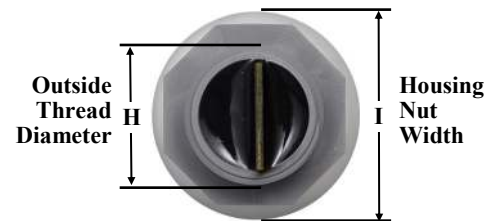

### Compact Housing

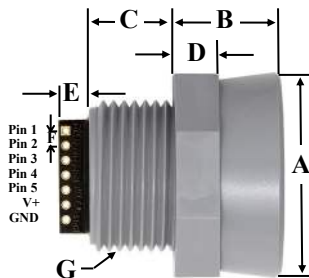

A	1.37" dia.	34.7 mm dia.
B	0.70"	17.9 mm
C	0.57"	14.4 mm
D	0.31"	7.9 mm
E	0.23"	5.8 mm
F	0.1"	2.54 mm
G	3/4"-14 NPS	
H	1.032" dia.	26.2 mm dia.
I	1.37"	34.8 mm
Weight, 1.23 oz., 32 grams		

Values Are Nominal



### 1" NPS Pipe Threading

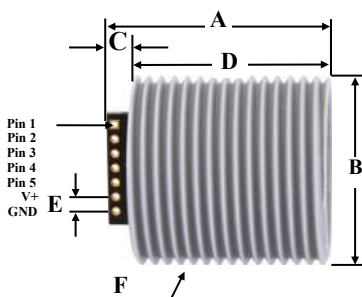

A	1.52"	38.5 mm
B	1.29" dia.	33.0 mm dia.
C	0.22"	5.5 mm
D	1.30"	33.1 mm
E	0.10"	2.54 mm
F	1" - NPS	
G	0.78"	19.81 mm
Weight, 1.23 oz., 35 grams		

Values Are Nominal

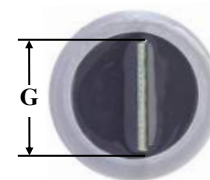



## Mechanical Dimensions Continued

### 1" BSPP Pipe Threading

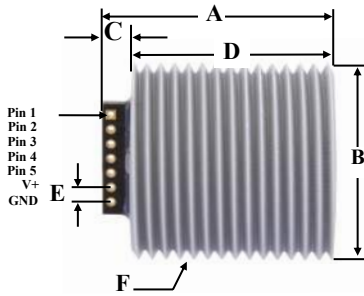

<b>A</b>	1.52"	38.5 mm
<b>B</b>	1.29" dia.	33.0 mm dia.
<b>C</b>	0.22"	5.5 mm
<b>D</b>	1.30"	33.1 mm
<b>E</b>	0.10"	2.54 mm
<b>F</b>	1" — BSPP	
<b>G</b>	0.78"	19.81 mm
Weight, 1.21 oz., 34.3 grams		

Values Are Nominal

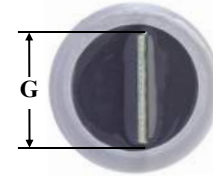

### 30mm1.5 Pipe Threading

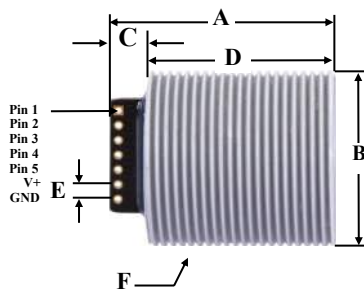

<b>A</b>	1.52"	38.5 mm
<b>B</b>	1.17" dia.	29.7 mm dia.
<b>C</b>	0.22"	5.5 mm
<b>D</b>	1.30"	33.1 mm
<b>E</b>	0.10"	2.54 mm
<b>F</b>	30mm 1.5	
<b>G</b>	0.78"	19.81 mm
Weight, 1.10 oz., 31.1 grams		

Values Are Nominal

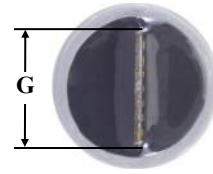

### Extended Horn

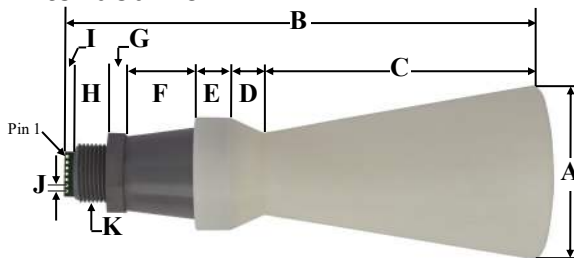

<b>A</b>	3.00" dia.	76.2 mm dia.
<b>B</b>	8.25"	209.6mm
<b>C</b>	4.827"	122.6mm
<b>D</b>	0.636"	16.2mm
<b>E</b>	0.580"	14.7mm

<b>F</b>	1.198"	30.4mm
<b>G</b>	0.31"	7.9mm
<b>H</b>	0.58"	14.7mm
<b>I</b>	0.23"	5.8mm
<b>J</b>	0.10"	2.54 mm

Values Are Nominal

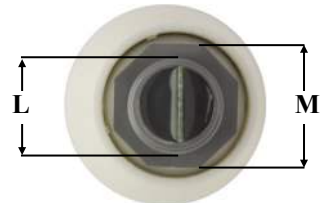

<b>K</b>	3/4"-14 NPS	
<b>L</b>	1.03" dia.	26.2 mm dia.
<b>M</b>	1.37"	34.8 mm
Weight		50 grams

## Operating Modes

### Free-Run Operation

When operating in free run mode, the HRXL-MaxSonar-WR sensors are designed to be used in a variety of outdoor, industrial, or indoor situations. Many acoustic noise sources will have little to no effect on the reported range of the HRXL-MaxSonar-WR sensors. Most range readings are accurately reported. If the range readings are affected, the effect is typically less than 5-mm<sup>1</sup>. This allows users to employ real-time ultrasonic distance sensing without the need for additional supporting circuitry or complicated user software.

Multiple HRXL-MaxSonar-WR sensors can be operated in the same general locations. The internal noise filter is able to filter out the ultrasonic noise from other HRXL-MaxSonar-WR sensors with minimal interference. Typically, when operating with multiple sensors, the range readings will be within ±1 cm of the actual range to the intended target.

**Notes:** <sup>1</sup> Refer to section that compares WR to WRC on page 4

Real-time or triggered operation allows users to take advantage of a few functions unavailable during free run mode. When operating in triggered mode, an unfiltered maximum refresh rate can be achieved. This triggered operation allows users to range targets moving away from or closer to the sensor faster than 240mm per reading.

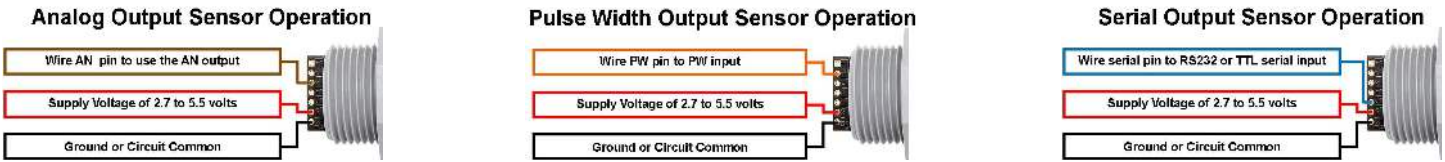

Users can enter and remain in the real-time or triggered operation by making sure that before the end each range cycle, the voltage level on Pin 4 is set low. After the sensor has completed the last reading, then Pin 4 is brought high. When Pin 4 is brought high, a brand new range cycle starts and the HRXL-MaxSonar-WR will output the most recent range data without filtering.

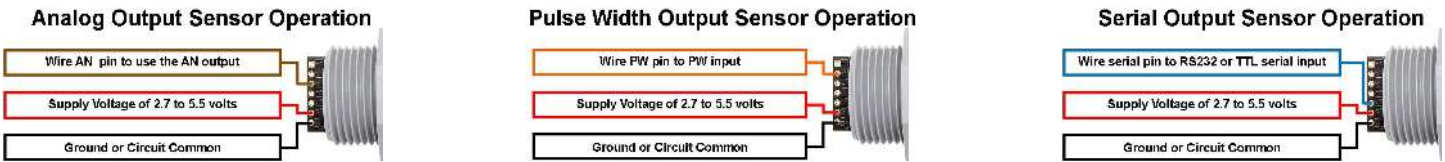

Readings during triggered operation are less accurate than the filtered operation by approximately  $\pm 5$ -mm. Because the range readings are not filtered, noise tolerance can be greatly reduced. Care should be taken to make sure that only one sensor is sampling range at a time.

**Sensor minimum distance - No sensor dead zone**

(MB7360, MB7369, MB7380, and MB7389)

The 5 meter sensors have a minimum reported distance of 30-cm (11.8 inches). However, the HRXL-MaxSonar-WR will report targets up to the sensor face (for the WR sensors)<sup>1</sup> and to within 1-mm of the front sensor face (for the WRC sensors)<sup>1</sup>. For the 5 meter HRXL-MaxSonar-WR sensors, targets closer than 300-mm will typically range as 300-mm.

Notes: <sup>1</sup> refers to section that compares WR to Alternative Packages on page 4

**Sensor minimum distance - No sensor dead zone**

(MB7363, MB7366, MB7368, MB7383, MB7386, and MB7388)

The 10 meter sensors have a minimum reported distance of 50-cm (19.7 inches). However, the HRXL-MaxSonar-WRL will report targets up to the sensor face. For the 10 meter HRXL-MaxSonar-WRL sensors, targets closer than 500-mm will typically range as 500-mm.

**Sensor minimum distance - No sensor dead zone**

(MB7375 and MB7395)

The 1.5 meter sensors have a minimum reported distance of 50-cm (19.7 inches). However, the HRXL-MaxSonar-WRB will report targets up to the sensor face. For the 1.5 meter HRXL-MaxSonar-WRB sensors, targets closer than 500-mm will typically range as 500-mm.

**Sensor operation from 30-cm to 50-cm**

Because of acoustic effects in the near field, objects between 30-cm and 50-cm may experience acoustic phase cancellation of the returning wave, resulting in inaccuracies of up to 5-mm. These effects become less prevalent as the target distance increases, and have not been observed past 50-cm. For this reason, users that require the highest accuracy are encouraged to mount the HRXL-MaxSonar-WR farther than 50-cm away from objects.

## HRXL-MaxSonar-WR Exposed Materials

The exposed materials of a properly mounted HRXL-MaxSonar-WR standard sensor are: Aluminum (oxidized surface), PVC, & silicone rubber (VMQ).

While most of our housings are made of PVC, our -8xx style extended horn products are made of ABS plastic. ABS is not compatible for use with gasoline. Direct contact will cause weakening and deformation of the horns. Extended exposure to vapors rising from gasoline may also damage these ABS housings.

## Additional Options for Purchase

Please contact MaxBotix for any additional information regarding the options listed below at [info@maxbotix.com](mailto:info@maxbotix.com)

### F-Option

In addition to the standard HRXL-MaxSonar-WR, MaxBotix Inc. has developed the F-Option for additional protection necessary in a few hazardous chemical environments. Extremely corrosive gases or liquids can degrade or compromise the operation of the sensing unit. As a result, we offer a more chemically inert seal which allows our sensors to operate in all but the harshest of chemical environments. In addition to the chemical resistance the sensor has improved performance in wet or dust environments.

Please Note: Our sensors are designed for operation in normal atmosphere (air). Please be aware that the speed of sound and atmospheric attenuation may change as a result of the transmission properties of different chemical/air mediums. Users are strongly encouraged to characterize and test the operation of the sensor in the new medium to verify operation, and properly scale the outputted range information.

The exposed materials of a properly mounted HRXL-MaxSonar-WR sensor with the F-Option added are: Aluminum (oxidized surface), PVC, & Fluorosilicone (with an additional back up FEP Teflon® seal<sup>1</sup>).

### Shielded Cable Attach Option

For simple integration of our sensors into end-user applications, MaxBotix has developed the Shielded Cable Attach option to create a completely IP67 rated MaxSonar-WR sensor. The standard Shielded Cable Attach Option uses 3 feet of the MaxSonar MB7954 Shielded Cable (MB7984 when attached by MaxBotix) with an epoxy filled cap to fully protect the pin-out of the MaxSonar sensor. Additional cable length can be specified and purchased using part number MB7984.

### P-Option

The P-Option is a Parylene coating applied to the surface of the aluminum transducer. This helps to improve the corrosion resistance of the aluminum transducer. The exposed materials of a properly mounted HRXL-MaxSonar-WR sensor with the P-Option added are: Parylene, PVC, & silicone rubber (VMQ). The F-Option can be purchased with the P-Option.

Notes: <sup>1</sup>30mm1.5 Pipe (-7XX) does not have the additional back up FEP Teflon® seal



### Range “0” location

The HRXL-MaxSonar-WR reports the range to distant targets from where the threading and nut meet on the sensor housing as shown in the diagram below.

In general, the HRXL-MaxSonar-WR will report the range to the leading edge of the closest detectable object. Target detection has been characterized in the sensor beam patterns.

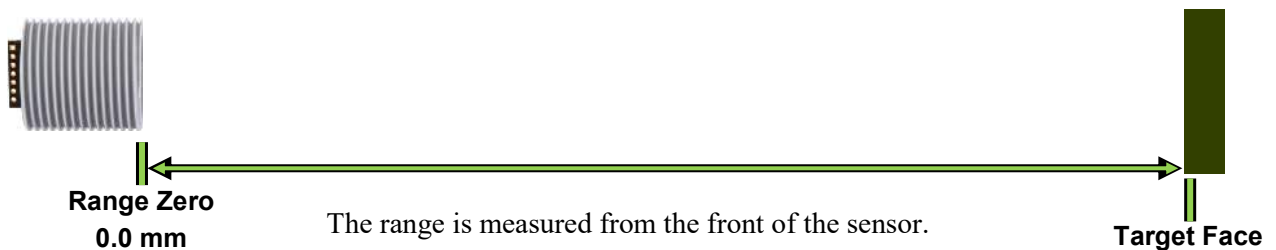
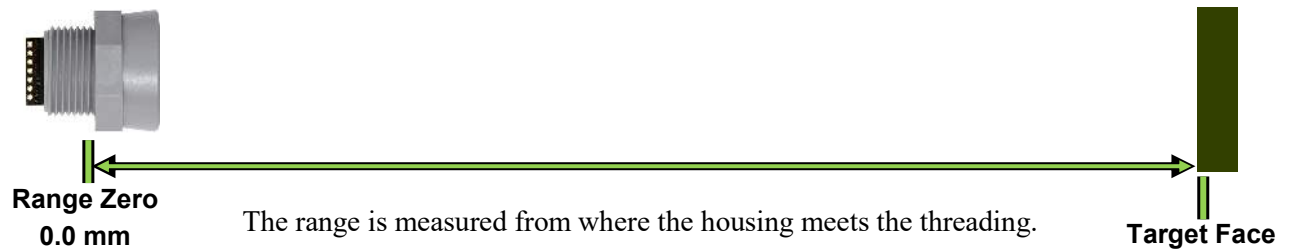
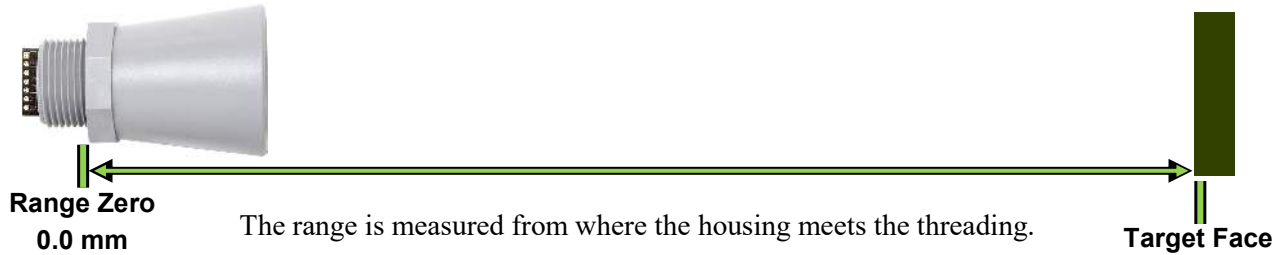

## Sensor Timing Diagrams

### Power Up Timing

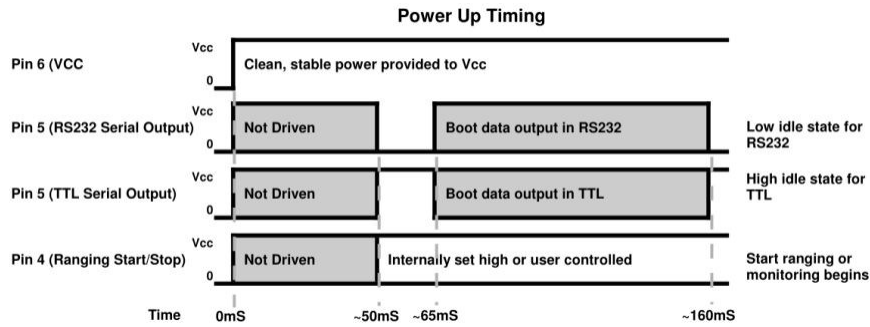

### Sensor Free-Run Timing

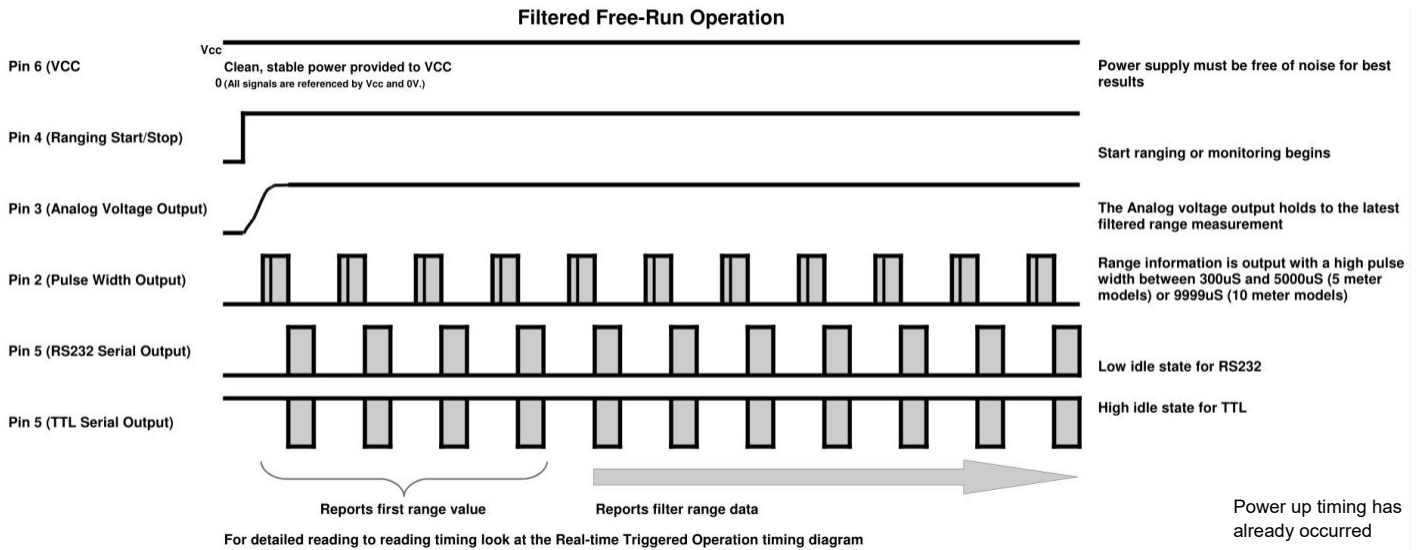

Product	Maximum Refresh Rate	Free Run Filter	Pulse Width Reported	Serial Data Reported	Pin 4 Brought Low	End of Range Cycle
MB7360, MB7367, MB7380, MB7387	7.5 Hz	1.5Hz	~118mS	~123mS	~132mS	~133mS
MB7369 and MB7389	6.67Hz	1.33Hz	~135mS	~140mS	~147mS	~148mS
MB7363, MB7366, MB7383, MB7386	6Hz	1.2Hz	~148mS	~158mS	~165mS	~166mS
MB7368 and MB7388	5.56Hz	1.11Hz	~163mS	~173mS	~180mS	~181mS
MB7375 and MB7395	6.33Hz	1.26Hz	~148mS	~150mS	~157mS	~158mS

When operating in free run mode, the HRXL-MaxSonar-WR sensors are designed to be used in a variety of outdoor, industrial, or indoor environments. Many acoustic noise sources will have little to no effect on the reported range of the HRXL-MaxSonar-WR sensors<sup>1</sup>. Most range readings are accurately reported<sup>1</sup>. If the range readings are affected, the effect is typically less than 5-mm<sup>1</sup>. This allows users to employ real-time ultrasonic distance sensing without the need for additional supporting circuitry or complicated user software.

The HRXL-MaxSonar-WR use an internal filter to process range data. This filter improves the sensor’s performance for accuracy, noise rejection, and reading to reading stability. The filtering in the free-run operation also permits additional acoustic and electrical noise tolerance.

On the HRXL-MaxSonar-WR sensors, when pin 4 is left high, the sensor will continue to range, the data output includes a filter for increased accuracy in environments with acoustic noise. The HRXL-MaxSonar-WR sensors will output the range based on recent range information. The filter does not affect the speed at which data is made available to the user but instead allows for more consistent range information to be presented.

**Notes:** <sup>1</sup> Refer to section that compares WR to WRC on page 4

## Sensor Timing Diagrams Cont.

### Triggered—Real-time Operation Timing

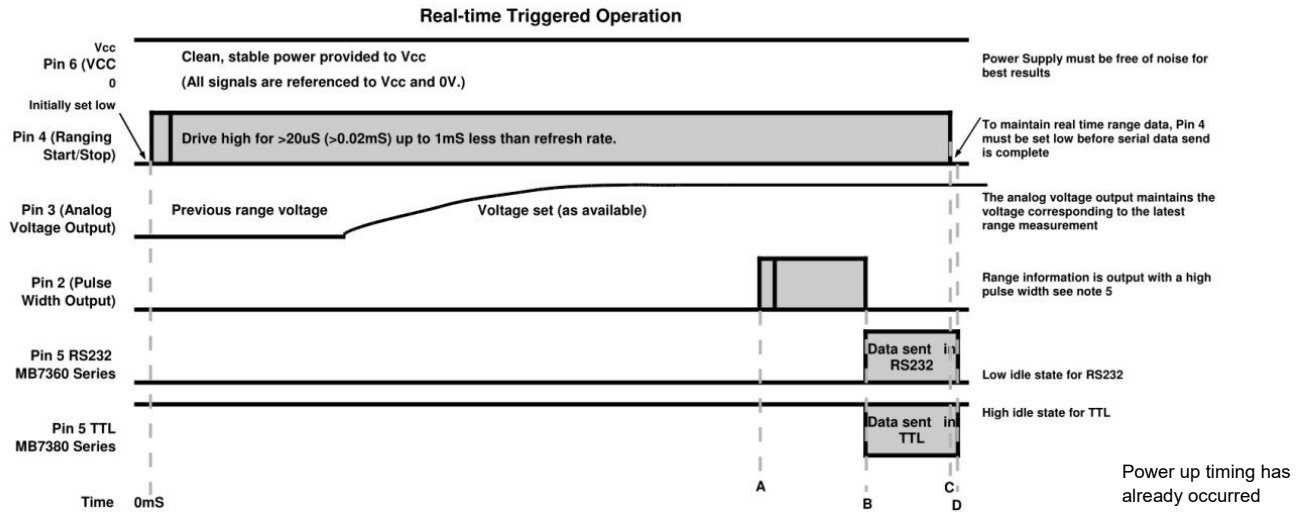

Product	Maximum Refresh Rate	Pulse Width sent (A)	Serial Data sent (B)	RX Pin set low (C)	End of range cycle (D)
MB7360, MB7367, MB7380, MB7387	7.5 Hz	~118mS	~123mS	~132mS	~133mS
MB7369 and MB7389	6.67Hz	~135mS	~140mS	~147mS	~148mS
MB7363, MB7366, MB7383, MB7386	6Hz	~148mS	~158mS	~165mS	~166mS
MB7368 and MB7388	5.17Hz	~163mS	~173mS	~180mS	~181mS
MB7375 and MB7395	6.33Hz	~148mS	~150mS	~157mS	~158mS

**Pulse Width data sent (Column A)** - Column A shows the approximate time that the sensor starts to output the pulse width data. The Pulse Width output time can be as short as 300uS (minimum reported distance). For 5 meter sensors, the pulse width can take as long as 5000uS (maximum reported distance) to be sent. For 10 meter sensors the Pulse Width can take as long as 9999uS (maximum reported distance) to be sent.

**Serial data sent (Column B)** - Column B shows the approximate time during each range cycle when the serial data is output for the sensor. Range data takes ~8mS to be reported from the serial data output.

**RX Pin set low (Column C)** - When operating the HRXL-MaxSonar-WR in Triggered Operation, Pin 4 is must be brought high for a time frame greater than 20uS (0.02mS) and less than the time in Column C in the chart above. If Pin 4 remains high for a period of time greater than the value in Column C, the sensor will switch into free-run filter operation.

**End of Range Cycle (Column D)** - Column D shows the approximate time each range cycle takes to complete for each sensor.

## Temperature Compensation On Board – Internal Temperature Compensation

The speed of sound in air increases by about 0.6 meters per second, per degree centigrade. Because of this, each HRXL-MaxSonar-WR is equipped with an internal temperature sensor which allows the sensor to apply compensation for speed of sound changes.

The actual air temperature of the path between the sensor and the target may not match the temperature measured at the sensor itself. Sensors can be mounted in vertical applications, or applications where the environment temperature gradient is severe. These users may experience a temperature measurement error which will affect the sensor accuracy. For example, buildings with a height of 3-meters can have floor to ceiling temperature variations of 5°C or more.

Because of these temperature effects, users desiring the highest accuracy output are encouraged to use a properly mounted external temperature sensor or to manually account for this measurement error.

## HR-MaxTemp, an External Temperature Sensor

Although the HRXL-MaxSonar-WR has an internal temperature sensor; for best accuracy, users are encouraged to use the optional external temperature sensor. On power-up, the HRXL-MaxSonar-WR will automatically detect an attached HR-MaxTemp temperature sensor and begin to apply temperature compensation using the external temperature sensor.

The external temperature sensor allows for the most accurate temperature compensation, by allowing temperature readings to be taken that better reflect the composite temperature of the acoustic ranging path. For best results, users are encouraged to connect the temperature sensor midway between the HRXL-MaxSonar-WR and the expected target.

## Voltage vs Temperature

The graphs below show minimum operating voltage of the sensor verses temperature.

The graph pictured below is applicable to the following sensors:

**MB7360, MB7369, MB7380 & MB7389**

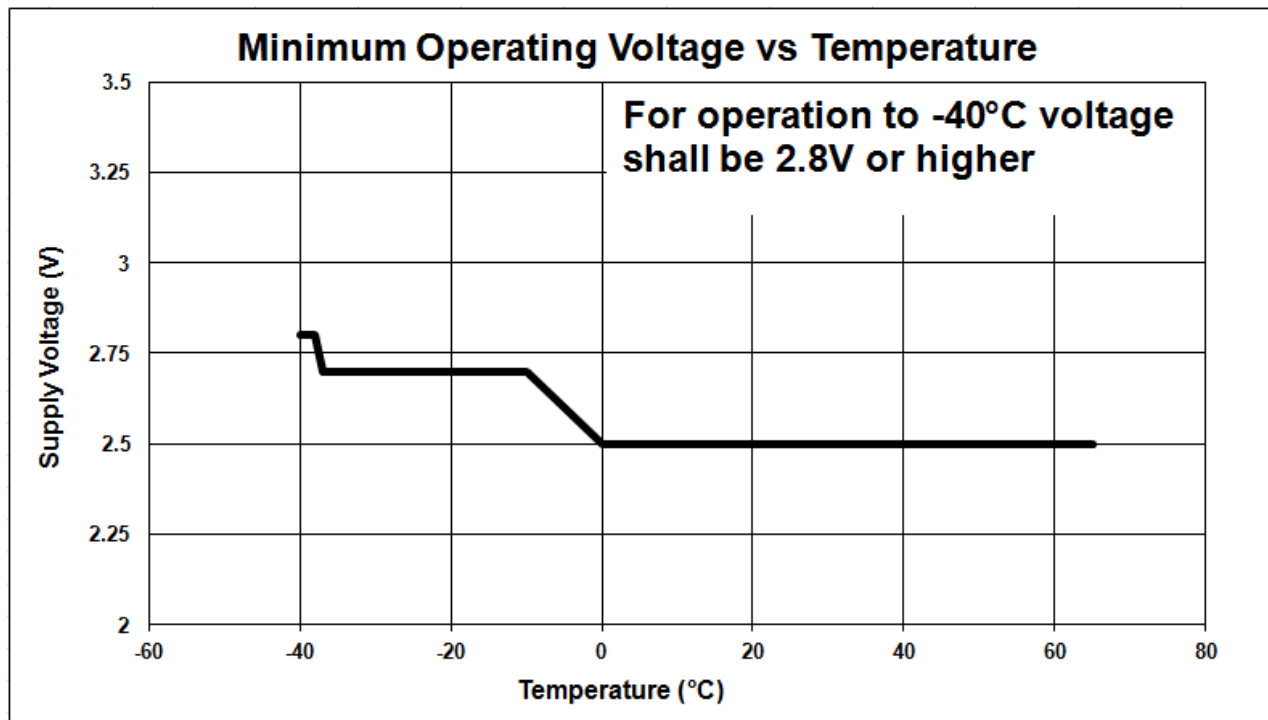

## Voltage vs Temperature

The graph pictured below is applicable to the following sensors:

**MB7363, MB7366, MB7368, MB7375, MB7383, MB7386, MB7388 & MB7395**

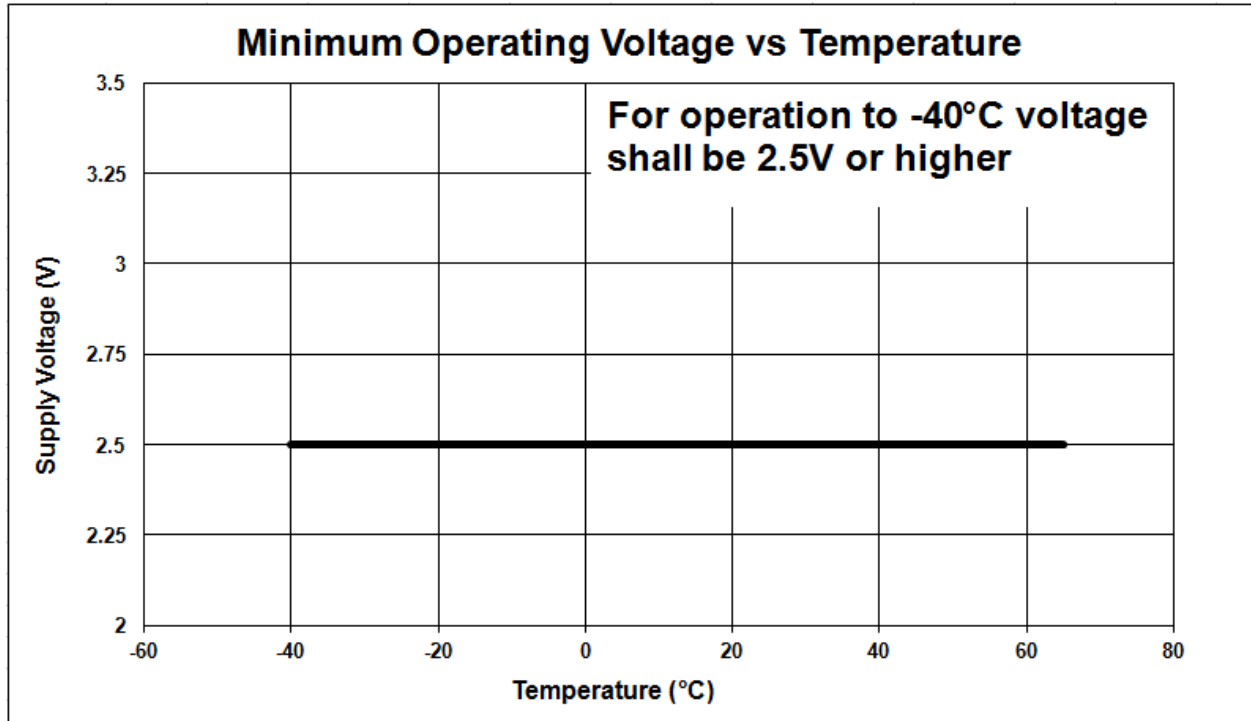

The graph pictured below is applicable to the following sensors:

**MB7367-WRC, MB7367-1" NPS, MB7367-1" BSPP, MB7367-30mm1.5  
 MB7369-WRC, MB7369-1" NPS, MB7369-1" BSPP, MB7369-30mm1.5  
 MB7387-WRC, MB7387-1" NPS, MB7387-1" BSPP, MB7387-30mm1.5  
 MB7389-WRC, MB7389-1" NPS, MB7389-1" BSPP, MB7389-30mm1.5**

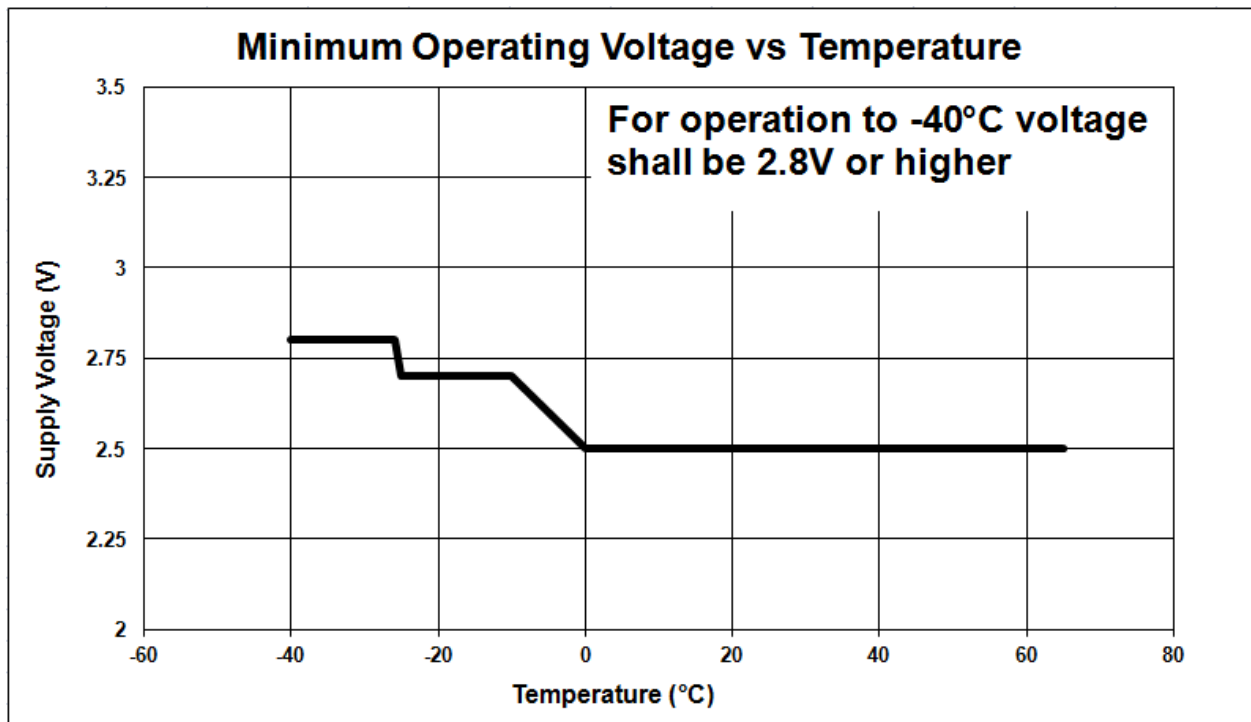



## Attenuation of Ultrasound

Attenuation, specifically absorption of sound through the air, restricts the maximum range of ultrasonic rangefinders. As sound waves travel through the air, that air absorbs some of their energy. High frequency sounds like ultrasound are often attenuated more quickly than lower frequency sounds. In addition to frequency, relative humidity also affect attenuation. Warm air masses with low relative humidity will typically attenuate sound waves faster. As such performance of ultrasonic devices may be limited at low relative humidity, especially when trying to detect targets at longer ranges.

## Background Information Regarding our Beam Patterns

Each HRXL-MaxSonar-WR sensor has a calibrated beam pattern. Each sensor is matched to provide the approximate detection pattern shown in this datasheet. This allows end users to select the part number that matches their given sensing application. Each part number has a consistent field of detection so additional units of the same part number will have similar beam patterns. The beam plots are provided to help identify an estimated detection zone for an application based on the acoustic properties of a target versus the plotted beam patterns.

Each beam pattern is a 2D representation of the detection area of the sensor. The beam pattern is actually shaped like a 3D cone (having the same pattern both vertically and horizontally). Beam patterns for dowels are used to show the beam pattern of each sensor. Dowels are long cylindrical targets of a given diameter. The dowels provide consistent target detection characteristics for a given size target which allows easy comparison of one MaxSonar sensor to another MaxSonar sensor.

For each part number, the four patterns (A, B, C, and D) represent the detection zone for a given target size. Each beam pattern shown is determined by the sensor's part number and target size.

The actual beam angle changes over the full range. Use the beam pattern for a specific target at any given distance to calculate the beam angle for that target at the specific distance. Generally, smaller targets are detected over a narrower beam angle and a shorter distance. Larger targets are detected over a wider beam angle and a longer distance.

### People Sensing:

For users that desire to detect people, the detection area to the 1-inch diameter dowel, in general, represents the area that the sensor will reliably detect people.

## Beam Pattern Target Shapes

- A 6.1-mm (0.25-inch) diameter dowel 4ft length
- B 2.54-cm (1-inch) diameter dowel 4ft length
- C 8.89-cm (3.5-inch) diameter dowel 4ft length
- D 11-inch wide board 4ft in length moved left to right with the board parallel to the front sensor face. This shows the sensor's range capability.

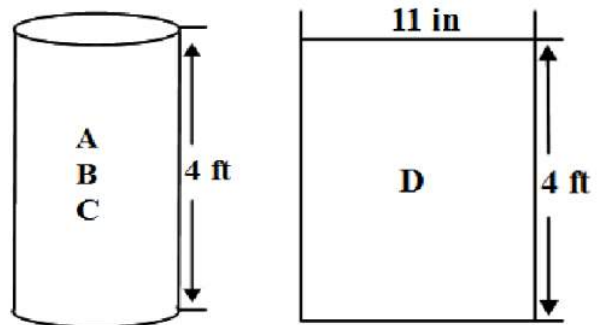

## Corner Reflectors

Sometimes when using an ultrasonic sensor, users experience detection of unwanted objects that appear outside the expected beam pattern. These types of detections are the result of reflectors present in the environment. Corner reflectors can be surprisingly small, yet present a large reflection back to the sensor. Certain objects are prone to causing corner reflections. One of the most common corner reflectors is two flat surfaces joining together to create a 90° angle. A half-circle also acts as a similar reflector. You can learn more about corner reflectors in our [Cube Corner Reflectors](#) article.

# MB7360-MB7380 HRXL-MaxSonar® -WR™ Beam Pattern and Uses

The HRXL-MaxSonar-WR product line has a narrow sensor beam and provides reliable long range detection zones.

## MB7360-1XX MB7380-1XX

### HRXL-MaxSonar® -WR/WRT™ Beam Pattern

Sample results for measured beam pattern are shown on a 30-cm grid. The detection pattern is shown for dowels of varying diameters that are placed in front of the sensor.

A 6.1-mm (0.25-inch) diameter dowel

B 2.54-cm (1-inch) diameter dowel

C 8.89-cm (3.5-inch) diameter dowel

D 11-inch wide board moved left to right with the board parallel to the front sensor face.

This shows the sensor's range capability.

**Note:** For people detection the pattern typically falls between charts A and B.

■ Partial Detection

— 5.0 V

● 3.3 V

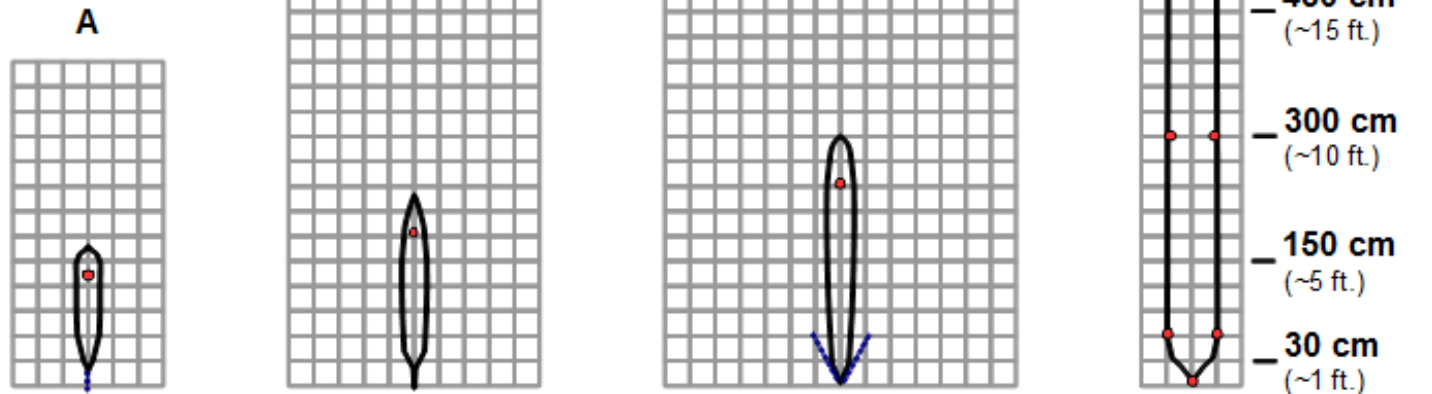

**Beam Characteristics are Approximate**

Beam Pattern drawn to a 1:95 scale for easy comparison to our other products.

### MB7360-MB7380

#### Features and Benefits

- Factory calibrated beam width
- Low operating voltages from 2.7V to 5.5V
- All range outputs are active simultaneously
- High acoustic sensitivity

### MB7360-MB7380

#### Applications and Uses

- Autonomous Navigation
- Robot Ranging Sensor
- Bin Level Measurement
- Tank Level Measurement

# MB7363-MB7383 HRXL-MaxSonar® -WRLS™ Beam Pattern and Uses

The HRXL-MaxSonar-WRLS sensors are 10 meter sensors with a higher sensitivity than other HRXL-MaxSonar-WR products. This sensor is recommended for applications in which objects do not reflect enough ultrasonic sound for other sensors to report the range to, such as people.

## MB7363-1XX MB7383-1XX

### HRXL-MaxSonar® -WRLS/WRLST™ Beam Pattern

Sample results for measured beam pattern are shown on a 30-cm grid. The detection pattern is shown for dowels of varying diameters that are placed in front of the sensor

- A 6.1-mm (0.25-inch) diameter dowel
- B 2.54-cm (1-inch) diameter dowel
- C 8.89-cm (3.5-inch) diameter dowel
- D 11-inch wide board moved left to right with the board parallel to the front sensor face. This shows the sensor's range capability.

- Partial Detection
- 5.0 V
- 3.3 V
- 2.7 V

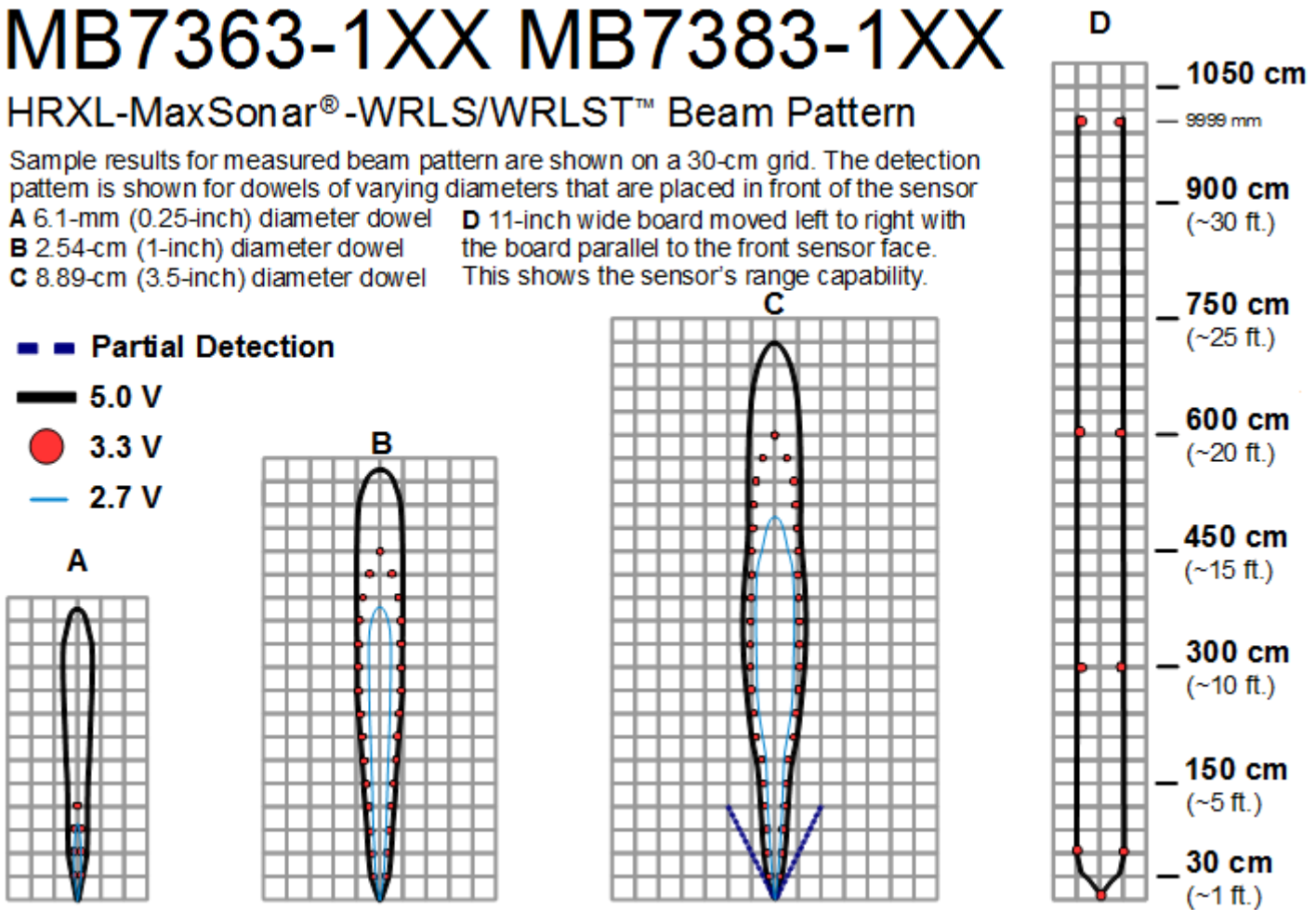

Beam Characteristics are Approximate

Beam Pattern drawn to a 1:95 scale for easy comparison to our other products.

### MB7363-MB7383

#### Features and Benefits

- Factory calibrated beam width
- Low operating voltages from 2.7V to 5.5V
- All range outputs are active simultaneously
- High acoustic sensitivity

### MB7363-MB7383

#### Applications and Uses

- Autonomous Navigation
- Robot Ranging Sensor
- Bin Level Measurement
- Tank Level Measurement

# MB7363-8XX MB7383-8XX

## HRXL-MaxSonar®-WRLS/WRLST™ Beam Pattern

Sample results for measured beam pattern are shown on a 30-cm grid. The detection Pattern is shown for dowels of varying diameters that are placed in front of the sensor.

A 6.1-mm (0.25-inch) diameter dowel

B 2.54-cm (1-inch) diameter dowel

C 8.89-cm (3.5-inch) diameter dowel

D 11-inch wide board with the board parallel to the front sensor face.

This shows the sensor's range capability.

**Note:** For people detection the pattern typically falls between charts A and B.

- 5.0V
- 3.3V
- 2.7V

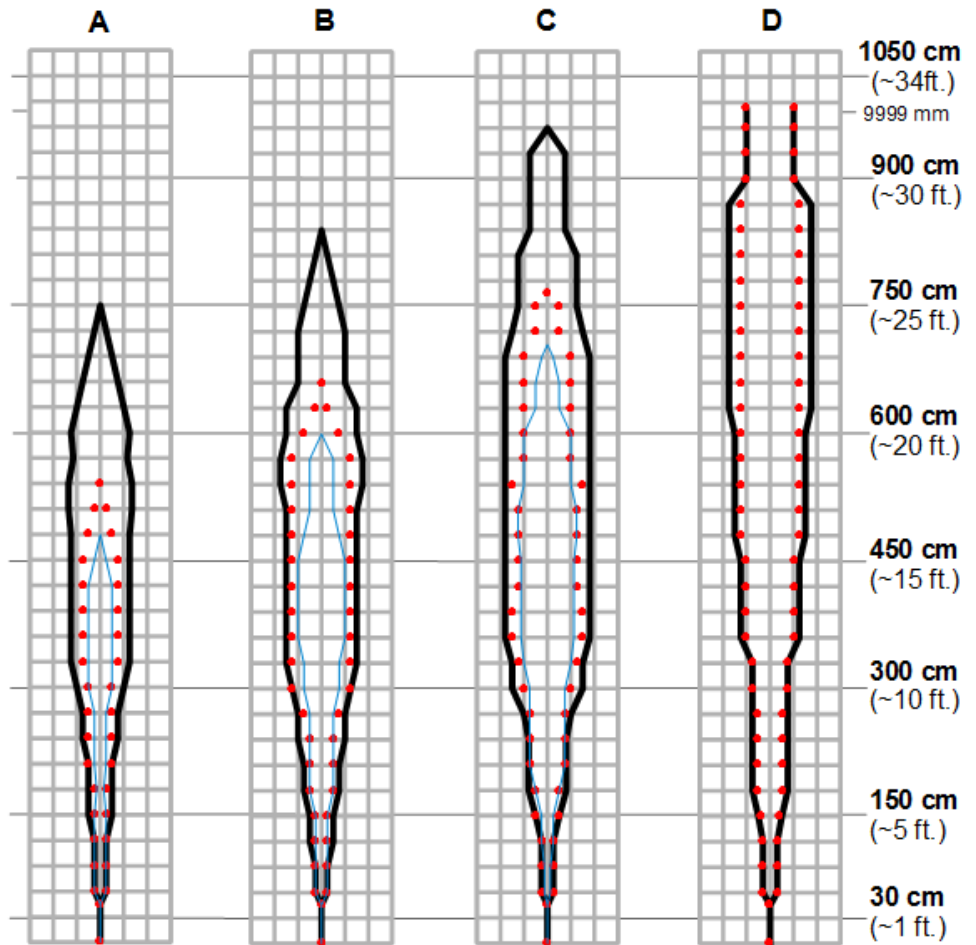

### Beam Characteristics are Approximate

Beam Pattern drawn to a 1:95 scale for easy comparison to our other products.

MaxBotix® Inc. For more information or latest product datasheets visit: [www.maxbotix.com](http://www.maxbotix.com)  
 The names MaxBotix, MaxSonar, EZ0, EZ1, EZ2, EZ3, EZ4, AE0, AE1, AE2, AE3, AE4, and WR1 are trademarks of MaxBotix Inc.

# MB7366-MB7386 HRXL-MaxSonar® -WRL™ Beam Pattern and Uses

The HRXL-MaxSonar-WRL sensors are a long range, 10 meter ultrasonic sensor.

## MB7366-1XX MB7386-1XX

### HRXL-MaxSonar® -WRL/WRLT™ Beam Pattern

Sample results for measured beam pattern are shown on a 30-cm grid. The detection pattern is shown for dowels of varying diameters that are placed in front of the sensor

- A 6.1-mm (0.25-inch) diameter dowel
- B 2.54-cm (1-inch) diameter dowel
- C 8.89-cm (3.5-inch) diameter dowel

D 11-inch wide board moved left to right with the board parallel to the front sensor face.

This shows the sensor's range capability.

**Note:** For people detection the pattern typically falls between charts A and B.

■ ■ Partial Detection

— 5.0 V

● 3.3 V

— 2.7 V

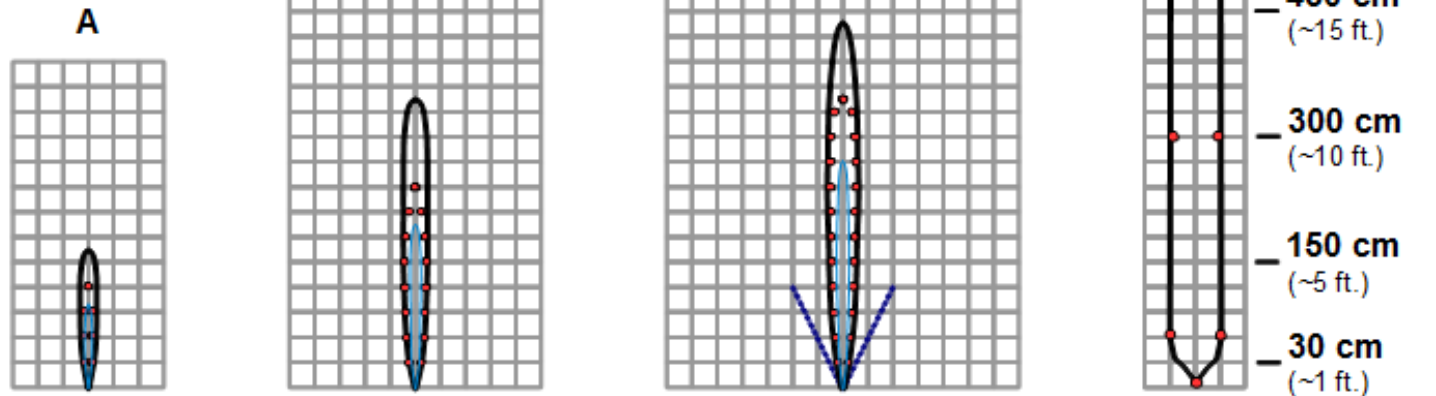

**Beam Characteristics are Approximate**

Beam Pattern drawn to a 1:95 scale for easy comparison to our other products.

### MB7366-MB7386

#### Features and Benefits

- Factory calibrated beam width
- Low operating voltages from 2.7V to 5.5V
- All range outputs are active simultaneously
- 10 meter range to large targets

### MB7366-MB7386

#### Applications and Uses

- Autonomous Navigation
- Robot Ranging Sensor
- Bin Level Measurement
- Tank Level Measurement
- Long Range Measurement



# MB7366-8XX MB7386-8XX

## HRXL-MaxSonar®-WRL/WRLT™ Beam Pattern

Sample results for measured beam pattern are shown on a 30-cm grid. The detection Pattern is shown for dowels of varying diameters that are placed in front of the sensor.

**A** 6.1-mm (0.25-inch) diameter dowel

**B** 2.54-cm (1-inch) diameter dowel

**C** 8.89-cm (3.5-inch) diameter dowel

**D** 11-inch wide board with the board parallel to the front sensor face.

This shows the sensor's range capability.

**Note:** For people detection the pattern typically falls between charts A and B.

- 5.0V
- 3.3V
- 2.7V

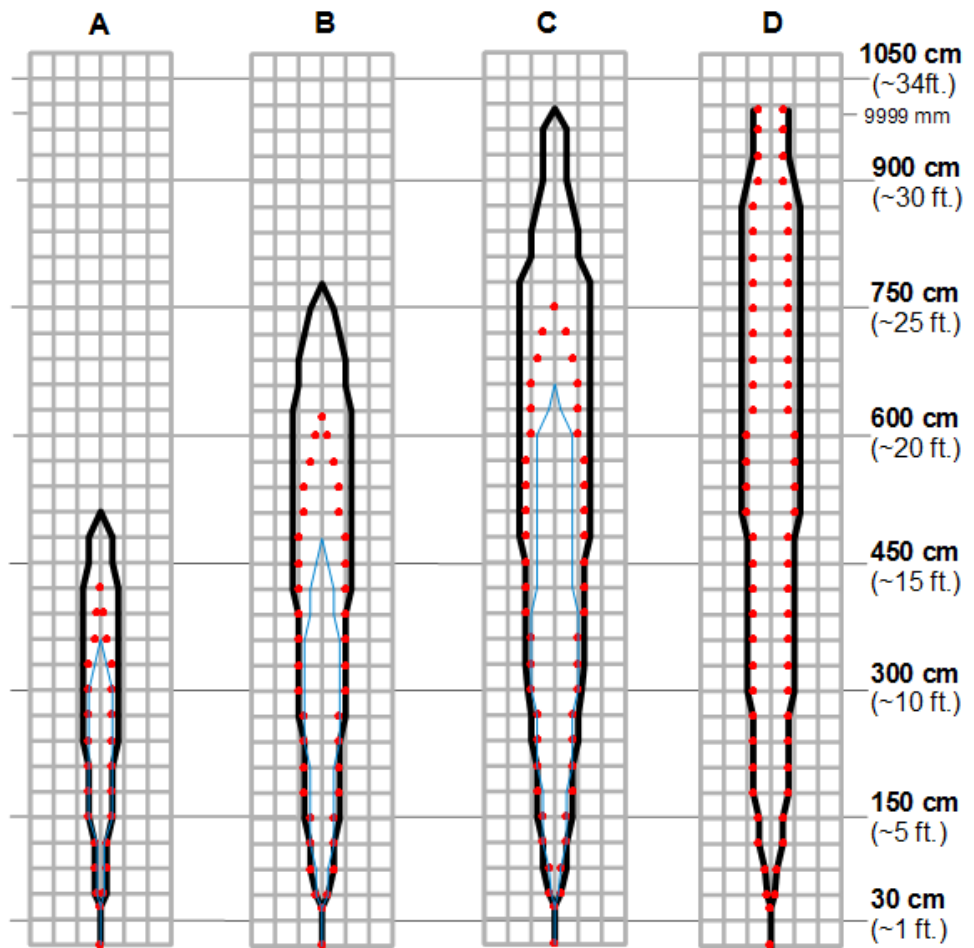

### Beam Characteristics are Approximate

Beam Pattern drawn to a 1:95 scale for easy comparison to our other products.

MaxBotix® Inc.

For more information or latest product datasheets visit: [www.maxbotix.com](http://www.maxbotix.com)

The names MaxBotix, MaxSonar, EZ0, EZ1, EZ2, EZ3, EZ4, AE0, AE1, AE2, AE3, AE4, and WR1 are trademarks of MaxBotix Inc.

# MB7368-MB7388 HRXL-MaxSonar® -WRML™ Beam Pattern and Uses

The HRXL-MaxSonar-WRML sensors are a long range, most 10 meter ultrasonic sensor with advance filtering that ranges to targets with the largest ultrasonic reflection, while ignoring smaller clutter.

## MB7368-1XX MB7388-1XX

### HRXL-MaxSonar®-WRML/WRMLT™ Beam Pattern

Sample results for measured beam pattern are shown on a 30-cm grid. The detection pattern is shown for dowels of varying diameters that are placed in front of the sensor.

**A** 6.1-mm (0.25-inch) diameter dowel

**B** 2.54-cm (1-inch) diameter dowel

**C** 8.89-cm (3.5-inch) diameter dowel

Partial Detection

5.0V

3.3V

2.7V

**D** 11-inch wide board moved left to right with the board parallel to the front sensor face.

This shows the sensor's range capability.

**Note:** For people detection the pattern typically falls between charts A and B.

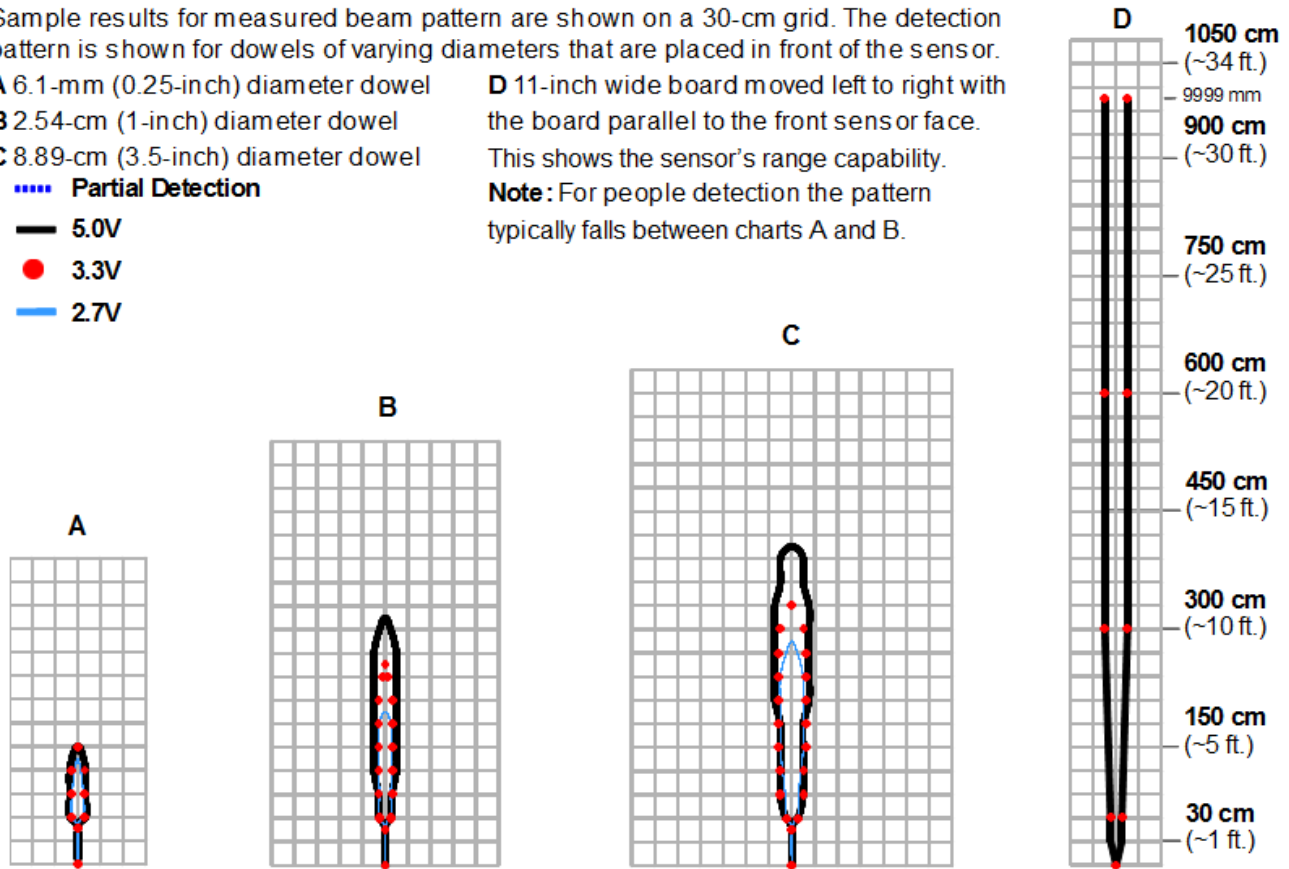

**Beam Characteristics are Approximate**

Beam Pattern drawn to a 1:95 scale for easy comparison to our other products.

### MB7368-MB7388

#### Features and Benefits

- Factory calibrated beam width
- Low operating voltages from 2.7V to 5.5V
- All range outputs are active simultaneously
- 10 meter range to large targets

### MB7368-MB7388

#### Applications and Uses

- Bin Level Measurement
- Tank Level Measurement
- Long Range Measurement

# MB7368-8XX MB7388-8XX

## HRXL-MaxSonar®-WRML/WRMLT™ Beam Pattern

Sample results for measured beam pattern are shown on a 30-cm grid. The detection Pattern is shown for dowels of varying diameters that are placed in front of the sensor.

A 6.1-mm (0.25-inch) diameter dowel

B 2.54-cm (1-inch) diameter dowel

C 8.89-cm (3.5-inch) diameter dowel

D 11-inch wide board with the board parallel to the front sensor face.

This shows the sensor's range capability.

**Note:** For people detection the pattern typically falls between charts A and B.

- 5.0V
- 3.3V
- 2.7V

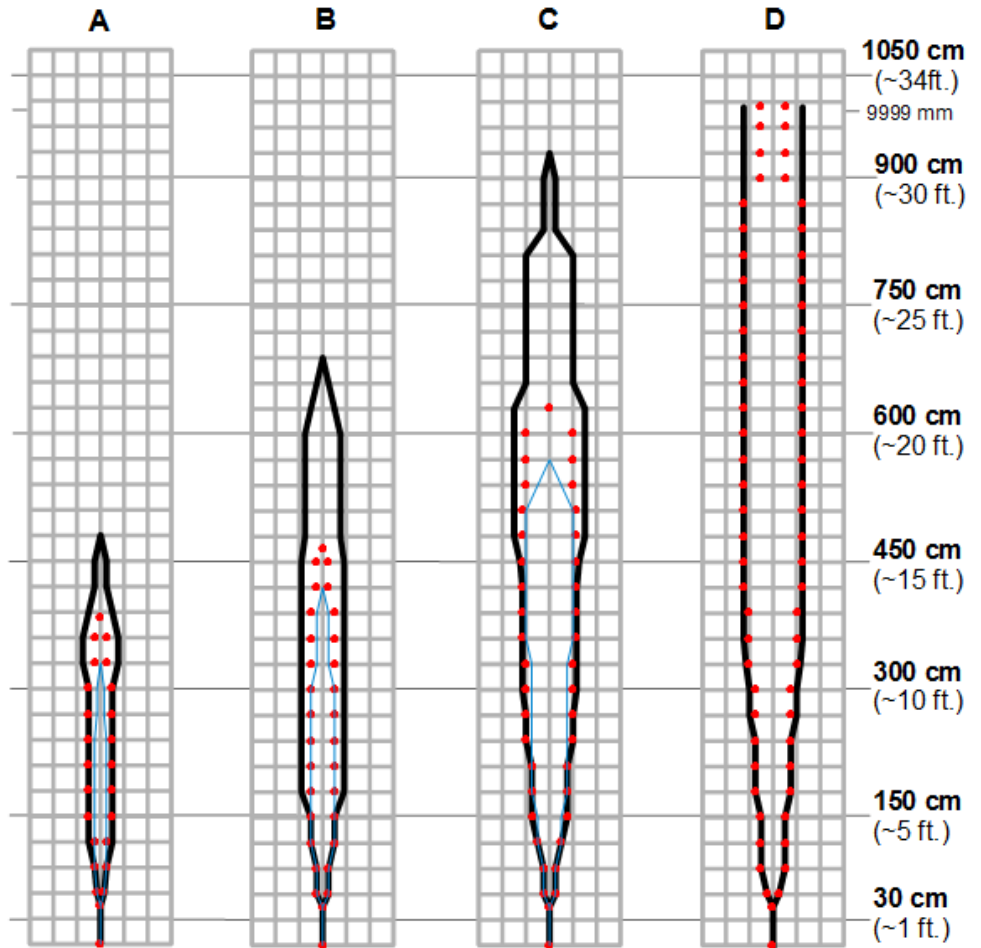

### Beam Characteristics are Approximate

Beam Pattern drawn to a 1:95 scale for easy comparison to our other products.

MaxBotix® Inc.

For more information or latest product datasheets visit: [www.maxbotix.com](http://www.maxbotix.com)

The names MaxBotix, MaxSonar, EZ0, EZ1, EZ2, EZ3, EZ4, AE0, AE1, AE2, AE3, AE4, and WR1 are trademarks of MaxBotix Inc.

# MB7369-MB7389 HRXL-MaxSonar® -WRM™ Beam Pattern and Uses

The HRXL-MaxSonar-WRM product line has a narrow sensor beam and advance filtering that ranges to targets with the largest ultrasonic reflection, while ignoring smaller clutter.

## MB7369-1XX MB7389-1XX

### HRXL-MaxSonar® -WRM/WRMT™ Beam Pattern

Sample results for measured beam pattern are shown on a 30-cm grid. The detection pattern is shown for dowels of varying diameters that are placed in front of the sensor.

- A 6.1-mm (0.25-inch) diameter dowel
- B 2.54-cm (1-inch) diameter dowel
- C 8.89-cm (3.5-inch) diameter dowel

D 11-inch wide board moved left to right with the board parallel to the front sensor face.

This shows the sensor's range capability.

**Note:** For people detection the pattern typically falls between charts A and B.

■ Partial Detection

— 5.0 V

● 3.3 V

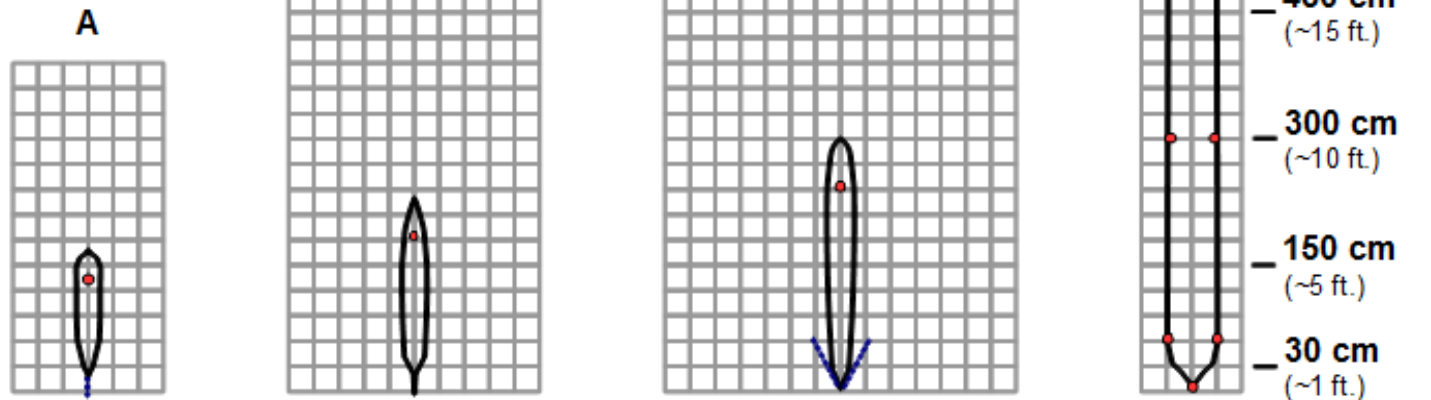

**Beam Characteristics are Approximate**

Beam Pattern drawn to a 1:95 scale for easy comparison to our other products.

### MB7369-MB7389

#### Features and Benefits

- Factory calibrated beam width
- Low operating voltages from 2.7V to 5.5V
- All range outputs are active simultaneously
- Superior clutter rejection

### MB7369-MB7389

#### Applications and Uses

- Bin Level Measurement
- Tank Level Measurement

## MB736X-MB738X HRXL-MaxSonar-WRC Beam Pattern and Uses

The HRXL-MaxSonar-WRC sensor product line has select models that are available in alternative housings that include a compact WRC form factor, 1" NPS pipe threading, 1" BSPP pipe threading, and 30mm 1.5 pipe threading.

<b>MB7360-2XX</b>	<b>MB7369-2XX</b>	<b>MB7380-2XX</b>	<b>MB7389-2XX</b>
<b>MB7360-5XX</b>	<b>MB7369-5XX</b>	<b>MB7380-5XX</b>	<b>MB7389-5XX</b>
<b>MB7360-6XX</b>	<b>MB7369-6XX</b>	<b>MB7380-6XX</b>	<b>MB7389-6XX</b>
<b>MB7360-7XX</b>	<b>MB7369-7XX</b>	<b>MB7380-7XX</b>	<b>MB7389-7XX</b>

### HRXL-MaxSonar® -Beam Pattern

Sample results for measured beam pattern are shown on a 30-cm grid. The detection pattern is shown for dowels of varying diameters that are placed in front of the sensor.

- A 6.1-mm (0.25-inch) diameter dowel
- B 2.54-cm (1-inch) diameter dowel
- C 8.89-cm (3.5-inch) diameter dowel

D 11-inch wide board moved left to right with the board parallel to the front sensor face. This shows the sensor's range capability.

**Note:** For people detection the pattern typically falls between charts A and B.

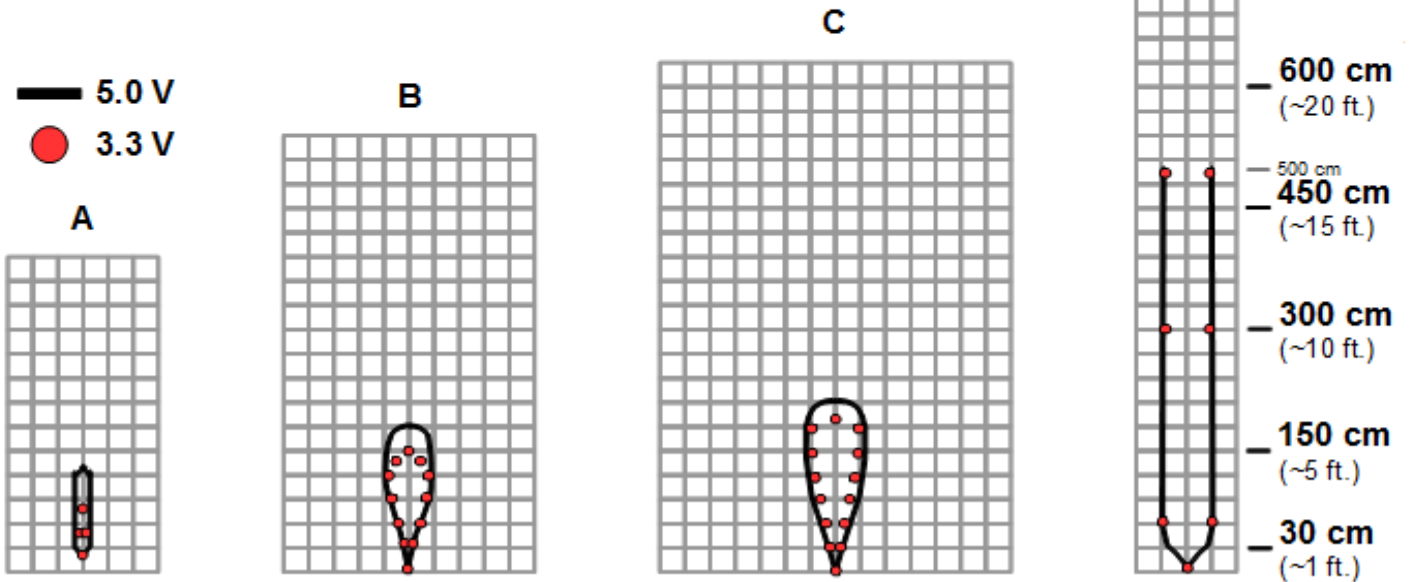

**Beam Characteristics are Approximate**

Beam Pattern drawn to a 1:95 scale for easy comparison to our other products.

### MB736X-MB738X Features and Benefits

- Extra Compact Housing
- Designed for outdoor or indoor environments
- Lightweight, compact, weather resistant design
- Low cost IP67 sensor
- Reliable and stable range data

### MB736X-MB738X Applications and Uses

- Applications with threaded pipe mounting



## MB7375-MB7395 HRXL-MaxSonar-WRB/WRBT Beam Pattern and Uses

The HRXL-MaxSonar-WRB sensors are the 1.525-meter (5-foot) wide beam versions of HRXL-MaxSonar-WRML sensors. The HRXL-MaxSonar-WRB sensor product line has select models that are available in alternative housings that include a compact WRC form factor, 1" NPS pipe threading, 1" BSPP pipe threading, and 30mm 1.5 pipe threading.

**MB7375-2XX    MB7395-2XX**  
**MB7375-5XX    MB7395-5XX**  
**MB7375-6XX    MB7395-6XX**  
**MB7375-7XX    MB7395-7XX**

### HRXL-MaxSonar®-WRB/WRBT™ Beam Pattern

Sample results for measured beam pattern are shown on a 30-cm grid. The detection pattern is shown for dowels of varying diameters that are placed in front of the sensor.

- A** 6.1-mm (0.25-inch) diameter dowel
- B** 2.54-cm (1-inch) diameter dowel
- C** 8.89-cm (3.5-inch) diameter dowel

**D** 11-inch wide board moved left to right with the board parallel to the front sensor face. This shows the sensor's range capability.

- ▬ Partial Detection
- ▬ 5.0V
- 3.3V
- ▬ 2.7V

**Note:** For people detection the pattern typically falls between charts A and B.  
**Max distance is 1525 mm**

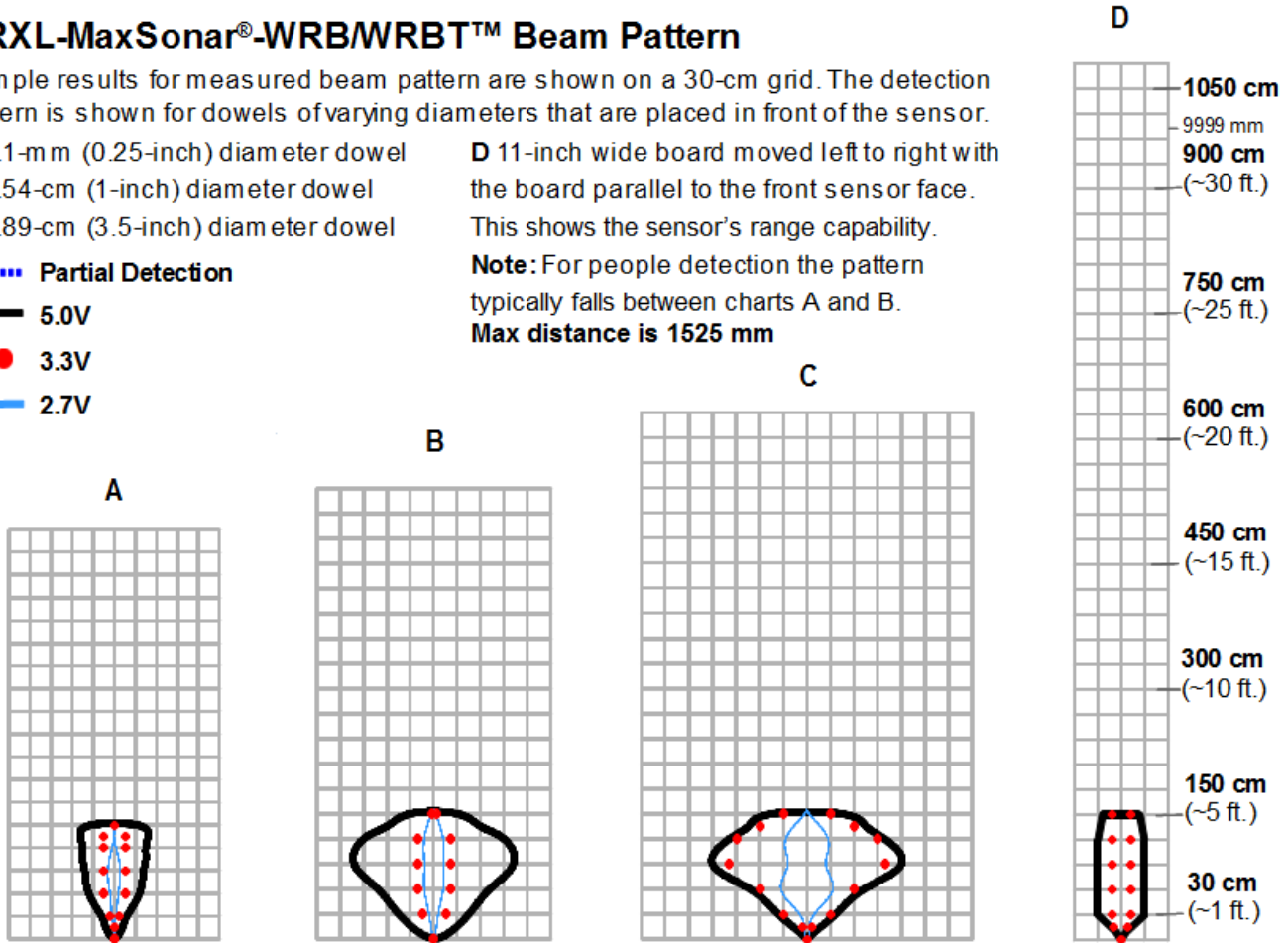

**Beam Characteristics are Approximate**

Beam Pattern drawn to a 1:95 scale for easy comparison to our other products.

### MB7375-MB7395 Features and Benefits

- Wide Beam
- Extra Compact Housing
- Designed for outdoor or indoor environments
- Lightweight, compact, weather resistant design
- Low cost IP67 sensor
- Reliable and stable range data

### MB7375-MB7395 Applications and Uses

- Applications with threaded pipe mounting

## Part Numbers

All part numbers are a combination of a six-character base followed by a dash and a three-digit product code. Please review the following table for more information on the three-digit product code.

Note: Active part numbers listed on pages 26, 27 and 28.

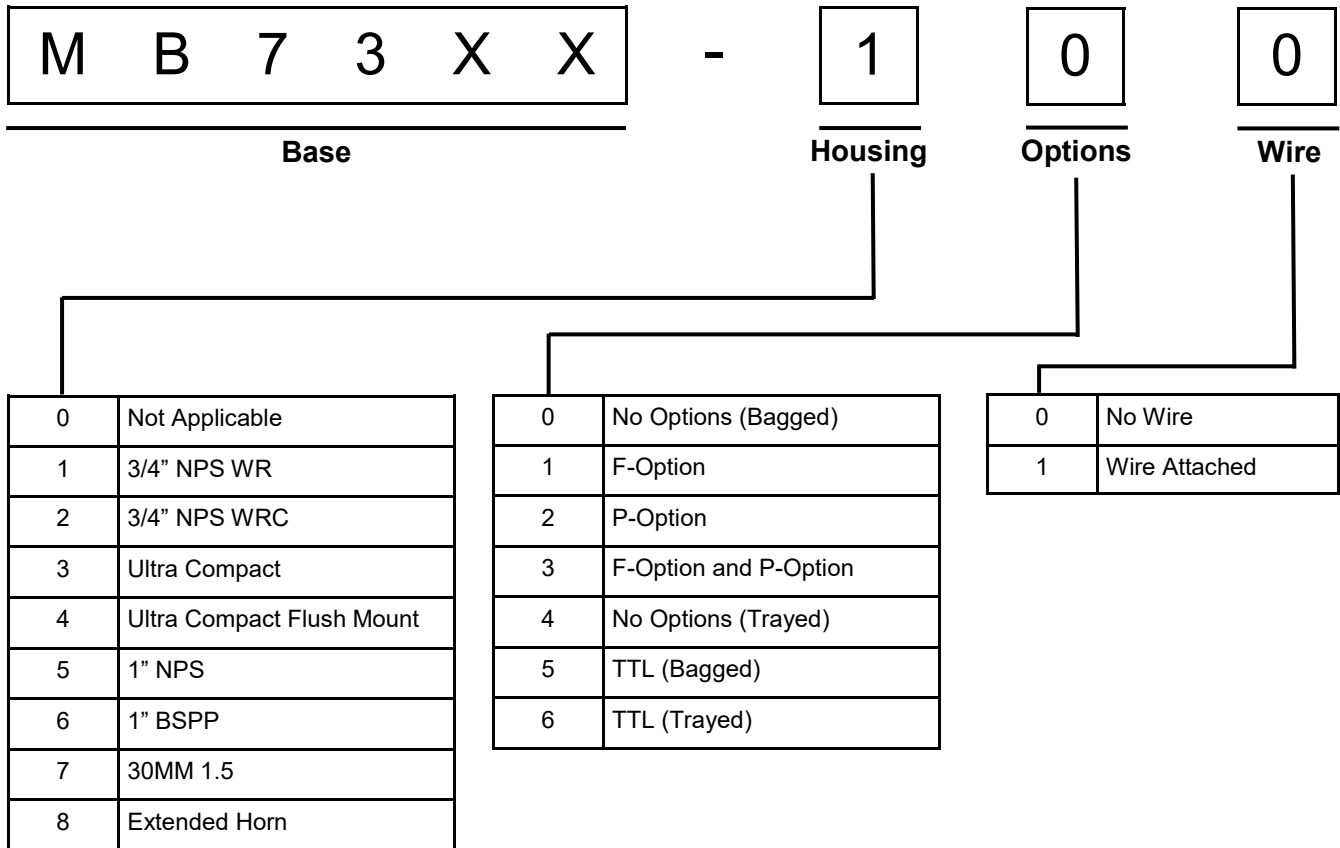

The following tables display all of the active and valid part numbers for these products.

Active Part Numbers for MB7360							
MB7360-100	MB7360-101	MB7360-110	MB7360-111	MB7360-120	MB7360-121	MB7360-130	MB7360-131
MB7360-200	MB7360-201	MB7360-210	MB7360-211	MB7360-220	MB7360-221	MB7360-230	MB7360-231
MB7360-500	MB7360-501	MB7360-510	MB7360-511	MB7360-520	MB7360-521	MB7360-530	MB7360-531
MB7360-600	MB7360-601	MB7360-610	MB7360-611	MB7360-620	MB7360-621	MB7360-630	MB7360-631
MB7360-700	MB7360-701	MB7360-710	MB7360-711	MB7360-720	MB7360-721	MB7360-730	MB7360-731

Active Part Numbers for MB7380							
MB7380-100	MB7380-101	MB7380-110	MB7380-111	MB7380-120	MB7380-121	MB7380-130	MB7380-131
MB7380-200	MB7380-201	MB7380-210	MB7380-211	MB7380-220	MB7380-221	MB7380-230	MB7380-231
MB7380-500	MB7380-501	MB7380-510	MB7380-511	MB7380-520	MB7380-521	MB7380-530	MB7380-531
MB7380-600	MB7380-601	MB7380-610	MB7380-611	MB7380-620	MB7380-621	MB7380-630	MB7380-631
MB7380-700	MB7380-701	MB7380-710	MB7380-711	MB7380-720	MB7380-721	MB7380-730	MB7380-731

The legacy part numbers MB7367 and MB7387 are now contained within MB7360 and MB7380 which are the base for all housing options on these products. To select a product with a legacy part number, select the desired housing option on the product with the appropriate base. Please review the following table for more information.

IF YOU BOUGHT	NOW BUY	
Legacy Part Number	Base and Housing	Active Part Number
MB7367– Compact	MB7360 in 3/4" NPS WRC Housing	MB7360-2XX
MB7367– 1" NPS	MB7360 in 1" NPS Housing	MB7360-5XX
MB7367– 1" BSPP	MB7360 in 1" BSPP Housing	MB7360-6XX
MB7367– 30mm 1.5	MB7360 in 30mm 1.5 Housing	MB7360-7XX
MB7387– Compact	MB7380 in 3/4" NPS WRC Housing	MB7380-2XX
MB7387– 1" NPS	MB7380 in 1" NPS Housing	MB7380-5XX
MB7387– 1" BSPP	MB7380 in 1" BSPP Housing	MB7380-6XX
MB7387– 30mm 1.5	MB7380 in 30mm 1.5 Housing	MB7380-7XX

The following tables display all of the active and valid part numbers for these products.

Active Part Numbers for MB7363							
MB7363-100	MB7363-101	MB7363-110	MB7363-111	MB7363-120	MB7363-121	MB7363-130	MB7363-131
MB7363-800	MB7363-801	MB7363-810	MB7363-811	MB7363-820	MB7363-821	MB7363-830	MB7363-831

Active Part Numbers for MB7366							
MB7366-100	MB7366-101	MB7366-110	MB7366-111	MB7366-120	MB7366-121	MB7366-130	MB7366-131
MB7366-800	MB7366-801	MB7366-810	MB7366-811	MB7366-820	MB7366-821	MB7366-830	MB7366-831

Active Part Numbers for MB7368							
MB7368-100	MB7368-101	MB7368-110	MB7368-111	MB7368-120	MB7368-121	MB7368-130	MB7368-131
MB7368-800	MB7368-801	MB7368-810	MB7368-811	MB7368-820	MB7368-821	MB7368-830	MB7368-831

Active Part Numbers for MB7369							
MB7369-100	MB7369-101	MB7369-110	MB7369-111	MB7369-120	MB7369-121	MB7369-130	MB7369-131
MB7369-200	MB7369-201	MB7369-210	MB7369-211	MB7369-220	MB7369-221	MB7369-230	MB7369-231
MB7369-500	MB7369-501	MB7369-510	MB7369-511	MB7369-520	MB7369-521	MB7369-530	MB7369-531
MB7369-600	MB7369-601	MB7369-610	MB7369-611	MB7369-620	MB7369-621	MB7369-630	MB7369-631
MB7369-700	MB7369-701	MB7369-710	MB7369-711	MB7369-720	MB7369-721	MB7369-730	MB7369-731

Active Part Numbers for MB7383							
MB7383-100	MB7383-101	MB7383-110	MB7383-111	MB7383-120	MB7383-121	MB7383-130	MB7383-131
MB7383-800	MB7383-801	MB7383-810	MB7383-811	MB7383-820	MB7383-821	MB7383-830	MB7383-831

Active Part Numbers for MB7386							
MB7386-100	MB7386-101	MB7386-110	MB7386-111	MB7386-120	MB7386-121	MB7386-130	MB7386-131
MB7386-800	MB7386-801	MB7386-810	MB7386-811	MB7386-820	MB7386-821	MB7386-830	MB7386-831

Active Part Numbers for MB7388							
MB7388-100	MB7388-101	MB7388-110	MB7388-111	MB7388-120	MB7388-121	MB7388-130	MB7388-131
MB7388-800	MB7388-801	MB7388-810	MB7388-811	MB7388-820	MB7388-821	MB7388-830	MB7388-831

Active Part Numbers for MB7389							
MB7389-100	MB7389-101	MB7389-110	MB7389-111	MB7389-120	MB7389-121	MB7389-130	MB7389-131
MB7389-200	MB7389-201	MB7389-210	MB7389-211	MB7389-220	MB7389-221	MB7389-230	MB7389-231
MB7389-500	MB7389-501	MB7389-510	MB7389-511	MB7389-520	MB7389-521	MB7389-530	MB7389-531
MB7389-600	MB7389-601	MB7389-610	MB7389-611	MB7389-620	MB7389-621	MB7389-630	MB7389-631
MB7389-700	MB7389-701	MB7389-710	MB7389-711	MB7389-720	MB7389-721	MB7389-730	MB7389-731

**Active Part Numbers for MB7375**

MB7375-200	MB7375-201	MB7375-210	MB7375-211	MB7375-220	MB7375-221	MB7375-230	MB7375-231
MB7375-500	MB7375-501	MB7375-510	MB7375-511	MB7375-520	MB7375-521	MB7375-530	MB7375-531
MB7375-600	MB7375-601	MB7375-610	MB7375-611	MB7375-620	MB7375-621	MB7375-630	MB7375-631
MB7375-700	MB7375-701	MB7375-710	MB7375-711	MB7375-720	MB7375-721	MB7375-730	MB7375-731

**Active Part Numbers for MB7395**

MB7395-200	MB7395-201	MB7395-210	MB7395-211	MB7395-220	MB7395-221	MB7395-230	MB7395-231
MB7395-500	MB7395-501	MB7395-510	MB7395-511	MB7395-520	MB7395-521	MB7395-530	MB7395-531
MB7395-600	MB7395-601	MB7395-610	MB7395-611	MB7395-620	MB7395-621	MB7395-630	MB7395-631
MB7395-700	MB7395-701	MB7395-710	MB7395-711	MB7395-720	MB7395-721	MB7395-730	MB7395-731



---

## After reviewing this datasheet, do you have any more questions?

We offer Technical Support on all of our products even if you purchased them through one of our many vendors worldwide.

You can **fill out a Technical Support form** for assistance on a sensor here --> [Technical Support](#)

## Not sure which sensor you need for your application?

We offer Sensor Selection Assistance, click the link here to fill out a form for support --> [Sensor Selection Help](#)

## Looking for tutorials to help you get started?

### [Frequently Asked Questions about Our Sensors](#)

We receive many questions about our products and services. This resource offers answers to common inquiries we receive about our product lines and their application.

### [Fully Calibrated Beam Patterns](#)

All of our sensors are factory calibrated to provide consistent beam patterns, detection zones, to fit into a wide variety of applications. In our product lines, each model number comes with a different beam pattern that reflects the sensitivity and the detection zone of how it sees a target. Additionally, we strive to maintain consistency between our finished products, and you will see little to no deviation between sensors of the same model. This allows you to have confidence in your final application when using multiple sensors.

### [Understanding Range Readings](#)

The success of an application may hinge upon knowing the exact location of a target. However, a sensor may report one meter even if the target is not exactly one meter away from the sensor. Sensor specifications, such as resolution, precision, and accuracy, help you to understand sensor performance.

### [How to Use Multiple Ultrasonic Sensors](#)

This guide covers three ways to run your sensors in a Multiple Sensor environment and issues you may face.

Contact us now with any questions at [sensors@maxbotix.com](mailto:sensors@maxbotix.com) or call +1-218-454-0766.

Please call during our preferred business hours of 8:00 am – 4:30 pm EST on Monday through Thursday and 8:00 am – 2:00 pm EST on Friday, or you may leave us a voicemail anytime.