

| P | LTR | DESCRIPTION | DATE | DWN | APVD |
|---|-----|---------------------------|-----------|-----|------|
| | BA | INITIAL RELEASE | 24JUL2019 | SR | AP |
| | BA1 | SCHEDULE ADDED TO DRAWING | 11OCT2022 | DM | AP |
| | BA2 | DRAWING SCHEDULE UPDATED | 22NOV2022 | DM | AP |

FOR FURTHER INFORMATION SEE DATA SHEET FOR MPT SERIES-THICK FILM POWER RESISTORS

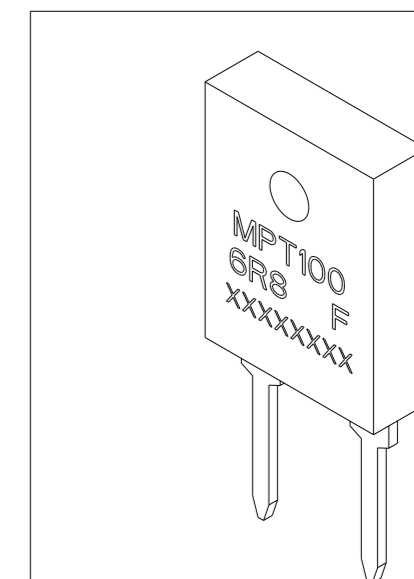
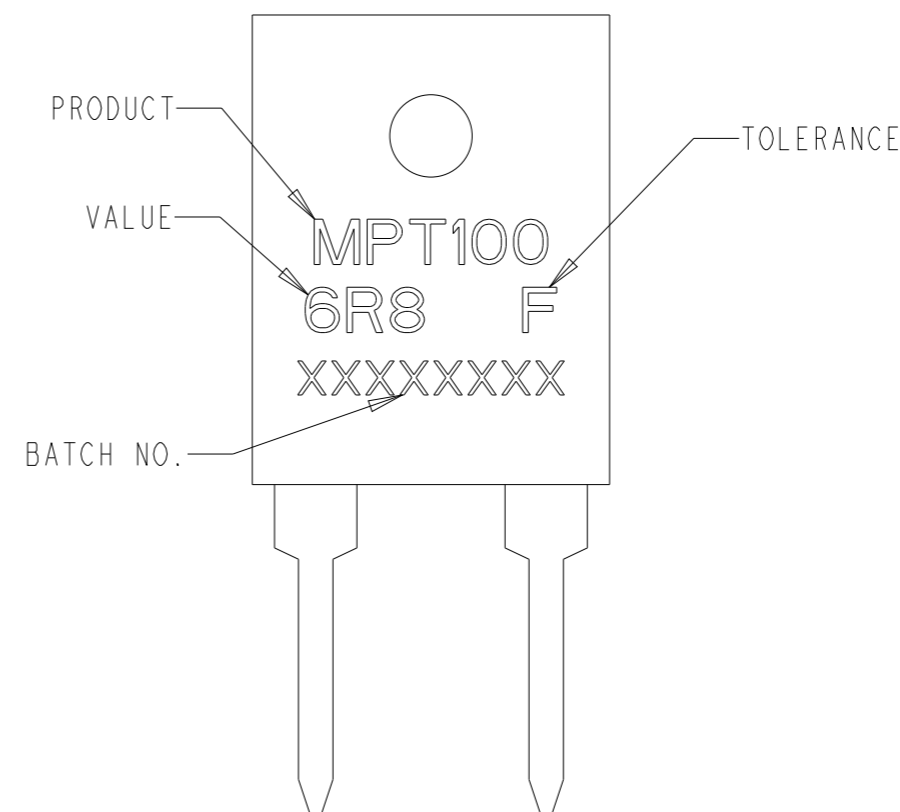
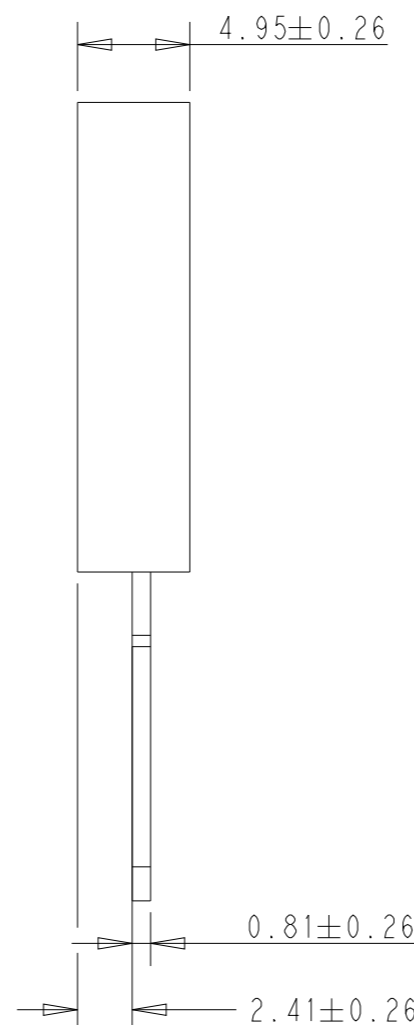
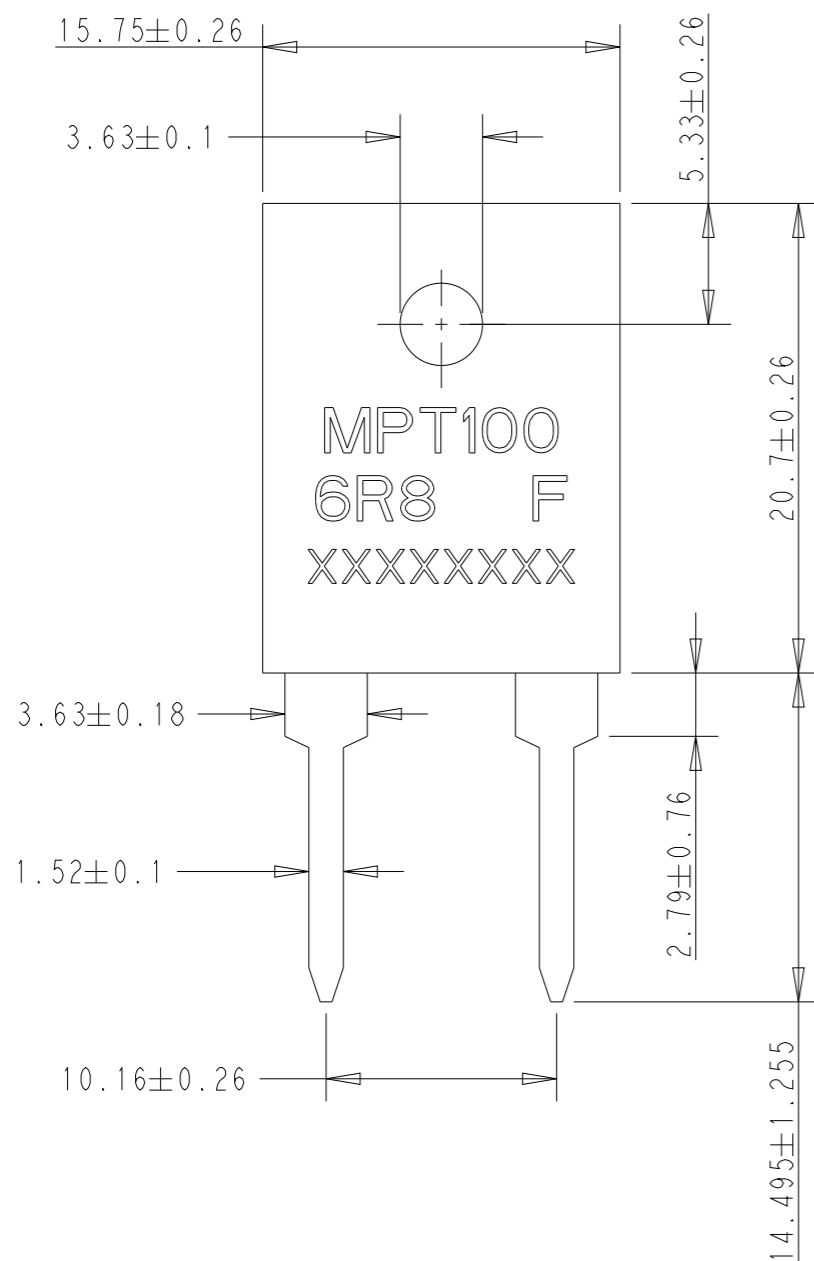

| | | | | | | |
|---|--|--------------------------|---|-----------|-----------------|-----------------|
| THIS DRAWING IS A CONTROLLED DOCUMENT. | | DWN SUPREETH R 24JUL2019 | | | SCALE 2:1 | |
| DIMENSIONS: mm | | CHK A. PILE 24JUL2019 | | | TE Connectivity | |
| TOLERANCES UNLESS OTHERWISE SPECIFIED: | | APVD A. PILE 24JUL2019 | NAME THICK FILM POWER RESISTOR TYPE MPT100 SERIES | | RESTRICTED TO | |
| 0 PLC ±- 1 PLC ±- 2 PLC ±- 3 PLC ±- 4 PLC ±- ANGLES ±- | | PRODUCT SPEC - | APPLICATION SPEC - | | SIZE A3 | CAGE CODE 00779 |
| MATERIAL - | | WEIGHT - | DRAWING NO. C-2176429 | | RESTRICTED TO - | |
| FINISH - | | CUSTOMER DRAWING | | SCALE 3:1 | SHEET 1 OF 3 | REV BA2 |

REVISIONS

| P | LTR | DESCRIPTION | DATE | DWN | APVD |
|---|-----|-------------|------|-----|------|
| | - | SEE SHEET 1 | - | - | - |
| | | | | | |
| | | | | | |

SCHEDULE

| TCPN | CATALOGUE NUMBER | PART DESCRIPTION | PART STATUS |
|-------------|------------------|------------------|-------------|
| 2176429-1 | MPT100XR10J | MPT100 R10 5% | PRODUCTION |
| 2176429-2 | MPT100XR15J | MPT100 R15 5% | PRODUCTION |
| 2176429-3 | MPT100XR22J | MPT100 R22 5% | PRODUCTION |
| 2176429-4 | MPT100XR33J | MPT100 R33 5% | PRODUCTION |
| 2176429-5 | MPT100XR47J | MPT100 R47 5% | PRODUCTION |
| 2176429-6 | MPT100XR68J | MPT100 R68 5% | PRODUCTION |
| 2176429-7 | MPT100X1R0J | MPT100 1R0 5% | PRODUCTION |
| 2176429-8 | MPT100T1R5J | MPT100 1R5 5% | PRODUCTION |
| 2176429-9 | MPT100T2R2J | MPT100 2R2 5% | PRODUCTION |
| 1-2176429-0 | MPT100A3R3J | MPT100 3R3 5% | PRODUCTION |
| 1-2176429-1 | MPT100A4R7J | MPT100 4R7 5% | PRODUCTION |
| 1-2176429-2 | MPT100A6R8J | MPT100 6R8 5% | PRODUCTION |
| 1-2176429-3 | MPT100A10RJ | MPT100 10R 5% | PRODUCTION |
| 1-2176429-4 | MPT100C15RJ | MPT100 15R 5% | PRODUCTION |
| 1-2176429-5 | MPT100C22RJ | MPT100 22R 5% | PRODUCTION |
| 1-2176429-6 | MPT100C33RJ | MPT100 33R 5% | PRODUCTION |
| 1-2176429-7 | MPT100C47RJ | MPT100 47R 5% | PRODUCTION |
| 1-2176429-8 | MPT100C68RJ | MPT100 68R 5% | PRODUCTION |
| 1-2176429-9 | MPT100C100RJ | MPT100 100R 5% | PRODUCTION |
| 2-2176429-0 | MPT100C150RJ | MPT100 150R 5% | PRODUCTION |
| 2-2176429-1 | MPT100C220RJ | MPT100 220R 5% | PRODUCTION |
| 2-2176429-2 | MPT100C330RJ | MPT100 330R 5% | PRODUCTION |
| 2-2176429-3 | MPT100C470RJ | MPT100 470R 5% | PRODUCTION |
| 2-2176429-4 | MPT100C680RJ | MPT100 680R 5% | PRODUCTION |
| 2-2176429-5 | MPT100C1K0J | MPT100 1K0 5% | PRODUCTION |
| 2-2176429-6 | MPT100C1K5J | MPT100 1K5 5% | PRODUCTION |
| 2-2176429-7 | MPT100C2K2J | MPT100 2K2 5% | PRODUCTION |
| 2-2176429-8 | MPT100C3K3J | MPT100 3K3 5% | PRODUCTION |
| 2-2176429-9 | MPT100C4K7J | MPT100 4K7 5% | PRODUCTION |
| 3-2176429-0 | MPT100C6K8J | MPT100 6K8 5% | PRODUCTION |

| TCPN | CATALOGUE NUMBER | PART DESCRIPTION | PART STATUS |
|-------------|------------------|------------------|-------------|
| 3-2176429-1 | MPT100C10KJ | MPT100 10K 5% | PRODUCTION |
| 3-2176429-2 | MPT100T1R2F | MPT100 1R2 1% | PRODUCTION |
| 3-2176429-3 | MPT100T1R5F | MPT100 1R5 1% | PRODUCTION |
| 3-2176429-4 | MPT100T1R8F | MPT100 1R8 1% | PRODUCTION |
| 3-2176429-5 | MPT100T2R2F | MPT100 2R2 1% | PRODUCTION |
| 3-2176429-6 | MPT100T2R7F | MPT100 2R7 1% | PRODUCTION |
| 3-2176429-7 | MPT100A3R3F | MPT100 3R3 1% | PRODUCTION |
| 3-2176429-8 | MPT100A3R9F | MPT100 3R9 1% | PRODUCTION |
| 3-2176429-9 | MPT100A4R7F | MPT100 4R7 1% | PRODUCTION |
| 4-2176429-0 | MPT100A5R6F | MPT100 5R6 1% | PRODUCTION |
| 4-2176429-1 | MPT100A6R8F | MPT100 6R8 1% | PRODUCTION |
| 4-2176429-2 | MPT100A8R2F | MPT100 8R2 1% | PRODUCTION |
| 4-2176429-3 | MPT100A10RF | MPT100 10R 1% | PRODUCTION |
| 4-2176429-4 | MPT100C12RF | MPT100 12R 1% | PRODUCTION |
| 4-2176429-5 | MPT100C15RF | MPT100 15R 1% | PRODUCTION |
| 4-2176429-6 | MPT100C18RF | MPT100 18R 1% | PRODUCTION |
| 4-2176429-7 | MPT100C22RF | MPT100 22R 1% | PRODUCTION |
| 4-2176429-8 | MPT100C27RF | MPT100 27R 1% | PRODUCTION |
| 4-2176429-9 | MPT100C33RF | MPT100 33R 1% | PRODUCTION |
| 5-2176429-0 | MPT100C39RF | MPT100 39R 1% | PRODUCTION |
| 5-2176429-1 | MPT100C47RF | MPT100 47R 1% | PRODUCTION |
| 5-2176429-2 | MPT100C56RF | MPT100 56R 1% | PRODUCTION |
| 5-2176429-3 | MPT100C68RF | MPT100 68R 1% | PRODUCTION |
| 5-2176429-4 | MPT100C82RF | MPT100 82R 1% | PRODUCTION |
| 5-2176429-5 | MPT100C100RF | MPT100 100R 1% | PRODUCTION |
| 5-2176429-6 | MPT100C120RF | MPT100 120R 1% | PRODUCTION |
| 5-2176429-7 | MPT100C150RF | MPT100 150R 1% | PRODUCTION |
| 5-2176429-8 | MPT100C180RF | MPT100 180R 1% | PRODUCTION |
| 5-2176429-9 | MPT100C220RF | MPT100 220R 1% | PRODUCTION |
| 6-2176429-0 | MPT100C270RF | MPT100 270R 1% | PRODUCTION |

THIS DRAWING IS A CONTROLLED DOCUMENT.

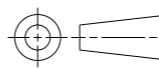
| | |
|---|--|
| DIMENSIONS: | TOLERANCES UNLESS OTHERWISE SPECIFIED: |
| mm | 0 PLC ±- |
|  | 1 PLC ±- |
| | 2 PLC ±- |
| | 3 PLC ±- |
| | 4 PLC ±- |
| | ANGLES ±- |
| MATERIAL | FINISH |
| - | - |
| - | - |

| | |
|------------------|-----------|
| DWN | 24JUL2019 |
| SUPREETH R | |
| CHK | 24JUL2019 |
| A. PILE | |
| APVD | 24JUL2019 |
| A. PILE | |
| PRODUCT SPEC | - |
| APPLICATION SPEC | - |
| WEIGHT | - |
| CUSTOMER DRAWING | |

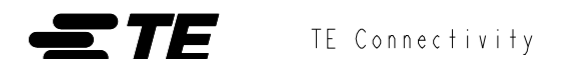

THICK FILM POWER RESISTOR
TYPE MPT100 SERIES

| | | | | |
|-------|-------|-----------|------------|---------------|
| NAME | SIZE | CAGE CODE | DRAWING NO | RESTRICTED TO |
| - | A3 | 00779 | ©-2176429 | - |
| SCALE | SHEET | OF | REV | |
| 3:1 | 2 | 3 | BA2 | |

REVISIONS

| P | LTR | DESCRIPTION | DATE | DWN | APVD |
|---|-----|-------------|------|-----|------|
| | - | SEE SHEET 1 | - | - | - |
| | | | | | |
| | | | | | |

| TCPN | CATALOGUE NUMBER | PART DESCRIPTION | PART STATUS |
|-------------|------------------|------------------|--------------|
| 6-2176429-1 | MPT100C330RF | MPT100 330R 1% | PRODUCTION |
| 6-2176429-2 | MPT100C390RF | MPT100 390R 1% | PRODUCTION |
| 6-2176429-3 | MPT100C470RF | MPT100 470R 1% | PRODUCTION |
| 6-2176429-4 | MPT100C560RF | MPT100 560R 1% | PRODUCTION |
| 6-2176429-5 | MPT100C680RF | MPT100 680R 1% | PRODUCTION |
| 6-2176429-6 | MPT100C820RF | MPT100 820R 1% | PRODUCTION |
| 6-2176429-7 | MPT100C1K0F | MPT100 1K0 1% | PRODUCTION |
| 6-2176429-8 | MPT100C1K2F | MPT100 1K2 1% | PRODUCTION |
| 6-2176429-9 | MPT100C1K5F | MPT100 1K5 1% | PRODUCTION |
| 7-2176429-0 | MPT100C1K8F | MPT100 1K8 1% | PRODUCTION |
| 7-2176429-1 | MPT100C2K2F | MPT100 2K2 1% | PRODUCTION |
| 7-2176429-2 | MPT100C2K7F | MPT100 2K7 1% | PRODUCTION |
| 7-2176429-3 | MPT100C3K3F | MPT100 3K3 1% | PRODUCTION |
| 7-2176429-4 | MPT100C3K9F | MPT100 3K9 1% | PRODUCTION |
| 7-2176429-5 | MPT100C4K7F | MPT100 4K7 1% | PRODUCTION |
| 7-2176429-6 | MPT100C5K6F | MPT100 5K6 1% | PRODUCTION |
| 7-2176429-7 | MPT100C6K8F | MPT100 6K8 1% | PRODUCTION |
| 7-2176429-8 | MPT100C8K2F | MPT100 8K2 1% | PRODUCTION |
| 7-2176429-9 | MPT100C10KF | MPT100 10K 1% | PRODUCTION |
| 8-2176429-0 | MPT100C200RF | MPT100 200R 1% | DISCONTINUED |
| 8-2176429-1 | MPT100C200RF | MPT100 200R 1% | PRODUCTION |

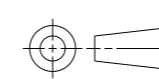
| | | | | | |
|---|--|--------------------------------|---|--------------------|-------------------------|
| THIS DRAWING IS A CONTROLLED DOCUMENT. | | DWN SUPREETH R 24JUL2019 |  TE Connectivity | | |
| DIMENSIONS: mm | | CHK A. PILE 24JUL2019 | | | |
| TOLERANCES UNLESS OTHERWISE SPECIFIED: | | APVD A. PILE 24JUL2019 | NAME THICK FILM POWER RESISTOR TYPE MPT100 SERIES | | |
|  | | PRODUCT SPEC - | RESTRICTED TO - | | |
| MATERIAL - | | APPLICATION SPEC - | SIZE A3 | CAGE CODE 00779 | DRAWING NO C-2176429 |
| FINISH - | | WEIGHT - | SCALE 3:1 | | SHEET 3 OF 3 |
| | | CUSTOMER DRAWING | | REV BA2 | |