

HRF-AT4510

15.5 dB, DC - 4GHz, 5 Bit Parallel Digital Attenuator

The Honeywell HRF-AT4510 is a 5-bit digital attenuator that is ideal for use in broadband communication system applications that require accuracy, speed and low power consumption. The HRF-AT4510 is manufactured with Honeywell's patented Silicon On Insulator (SOI) CMOS manufacturing technology, which provides the performance of GaAs with the economy and integration capabilities of conventional CMOS. These attenuators are DC coupled to improve lower operating frequency, frequency response and reduce the number of DC bias points required.

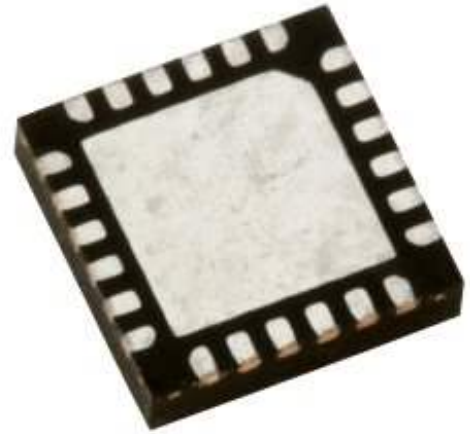

HRF-AT4510 in VQFN Package

FEATURES

- Very Low DC Power Consumption
- Attenuation In Steps From 0.5 dB To 15.5 dB
- Single Positive Power Supply Voltage
- Parallel Data Interface
- 50 Ohm Impedance
- DC-coupled, bi-directional RF path
- Space Saving VQFN Surface Mount Packaging

RF ELECTRICAL SPECIFICATIONS @ + 25°C

Results @ $V_{DD} = 5.0 \pm 10\%$, $V_{SS} = 0$ unless otherwise stated, $Z_0 = 50$ Ohms
 Contact Honeywell for relative performance at other supply configurations

Parameter	Test Condition	Frequency	Minimum	Typical	Maximum	Units
Insertion Loss		0.5 GHz		1.6	2.2	dB
		2.0 GHz		2.0	2.4	dB
		3.0 GHz		2.4	2.9	dB
		4.0 GHz		4.4	5.0	dB
1dB Compression	$V_{SS} = 0V$, Input Power	2.0 GHz		20		dBm
	$V_{SS} = -3V$, Input Power	2.0 GHz		26		dBm
Input IP3	$V_{SS} = 0V$ Two-tone inputs, up to +5 dBm @ 0 dB attenuation	2.0 GHz		36.0		dBm
Input IP3	$V_{SS} = -3V$ Two-tone inputs, up to +5 dBm @ 0 dB attenuation	2.0 GHz		>36.0		dBm
Return Loss	Any Bit or Combination of Bits		-11	-15		dB
Attenuation Accuracy	All attenuation states	1.0 GHz	+/- (0.15 + 3% of programmed IL)			dB
	All attenuation states	2.0 GHz	+/- (0.20 + 3% of programmed IL)			dB
	All attenuation states	3.0 GHz	+/- (0.30 + 3% of programmed IL)			dB
	All attenuation states	4.0 GHz	+/- (0.45 + 3% of programmed IL)			dB
Trise, Tfall Ton, Toff (Tpd)	10% To 90%			10		nS
	50% Cntl To 90% / 10%RF			15		nS

HRF-AT4510

FUNCTIONAL SCHEMATIC

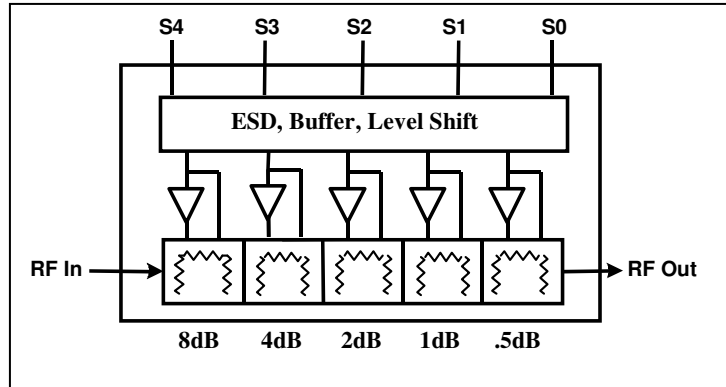

DC ELECTRICAL SPECIFICATIONS @ + 25°C

Parameter	Minimum	Typical	Maximum	Units
V _{DD}	3.3	5.0	5.5	V
V _{SS}	-5.0			V
I _{DD}		<5.0	50	uA
CMOS Logic level (0)	0		0.8	V
CMOS Logic level (1)	V _{DD} - 0.8		V _{DD}	V
Input Leakage Current			10	uA

Note 1, the performance curves are for V_{DD} = +5.0 +/- 10%

ABSOLUTE MAXIMUM RATINGS¹

Parameter	Absolute Maximum	Units
Input Power	+ 35	dBm
V _{DD}	+6.0	V
V _{SS}	-5.5	V
ESD Voltage ²	400	V
Operating Temperature	-40 To +85	Degrees C
Storage Temperature	-65 To +125	Degrees C
Moisture Sensitivity Level	Level 1	
Digital Inputs	V _{DD} +0.6 max to -0.6 min	V

Note 1 - Operation of this device beyond any of these parameters may cause permanent damage.

Note 2 - Although the HRF-AT4510 contains ESD protection circuitry on all digital inputs, precautions should be taken to ensure that the Absolute Maximum Ratings are not exceeded.

Latch-Up: Unlike conventional CMOS digital attenuators, Honeywell's HRF-AT4510 is immune to latch-up.

HRF-AT4510

PIN CONFIGURATIONS

Pin	Function	Pin	Function
1	VDD	13	GROUND
2	GROUND	14	GROUND
3	GROUND	15	RF OUTPUT
4	RF INPUT	16	GROUND
5	GROUND	17	VSS
6	GROUND	18	GROUND
7	GROUND	19	S0
8	GROUND	20	S1
9	GROUND	21	S2
10	GROUND	22	S3
11	GROUND	23	S4
12	GROUND	24	OPEN

Note: Bottom ground plate must be grounded for proper RF performance.

TRUTH TABLE

S4	S3	S2	S1	S0	Output
0	0	0	0	0	Reference Input
0	0	0	0	1	0.5 dB
0	0	0	1	0	1 dB
0	0	1	0	0	2 dB
0	1	0	0	0	4 dB
1	0	0	0	0	8 dB
1	1	1	1	1	15.5 dB

Operation: Data on parallel input "S" pins are independently buffered and presented to the RF attenuator circuits.
"0" = CMOS Low, "1" = CMOS High.

HRF-AT4510

PERFORMANCE CURVES

Insertion Loss

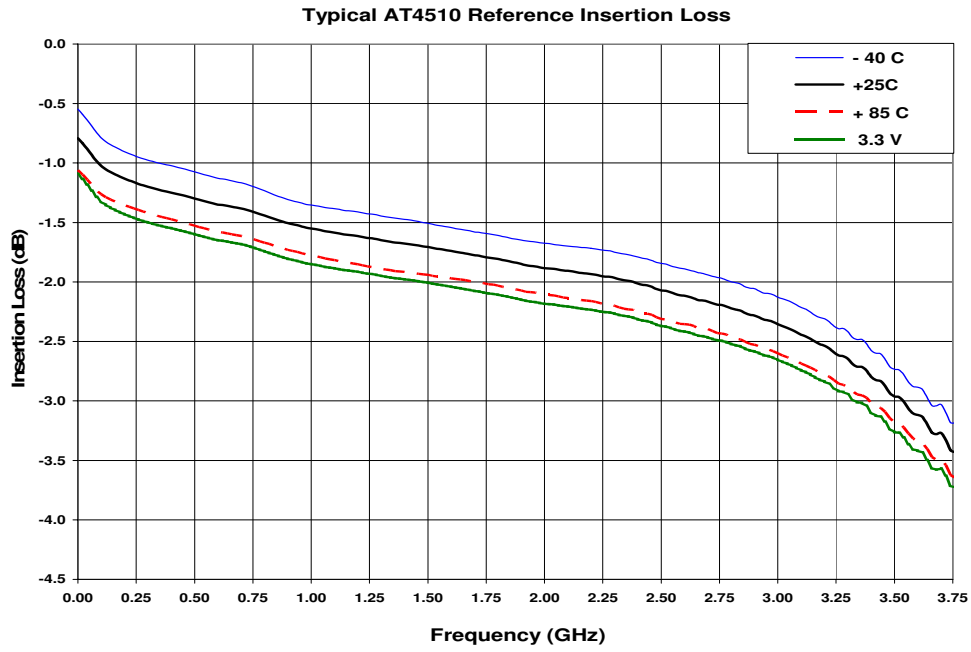

Return Loss

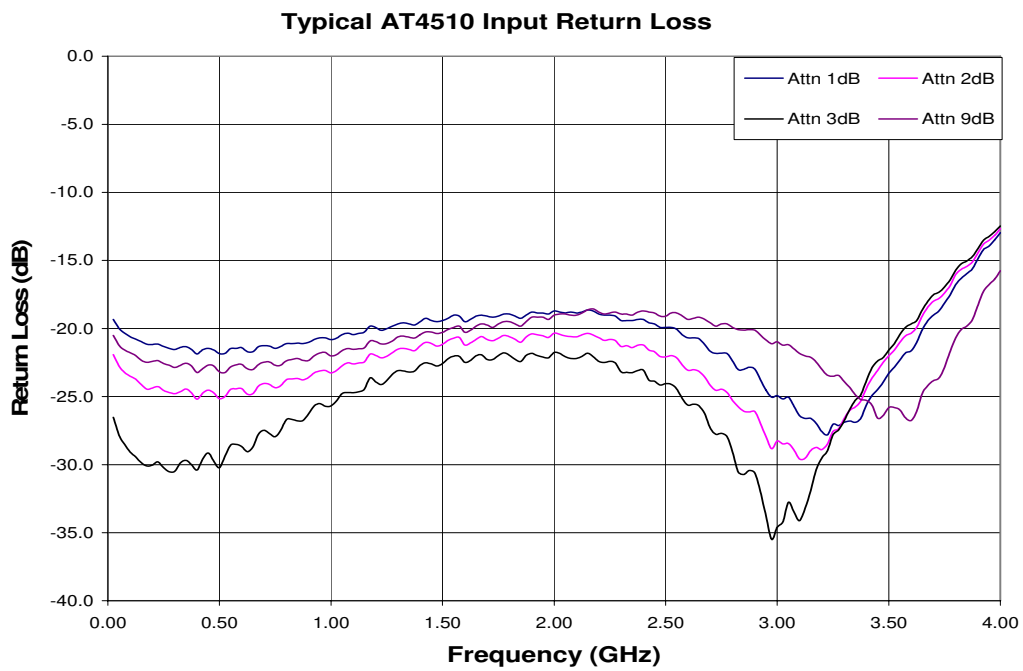

HRF-AT4510

Step Accuracy

Typical AT4510 Step Accuracy

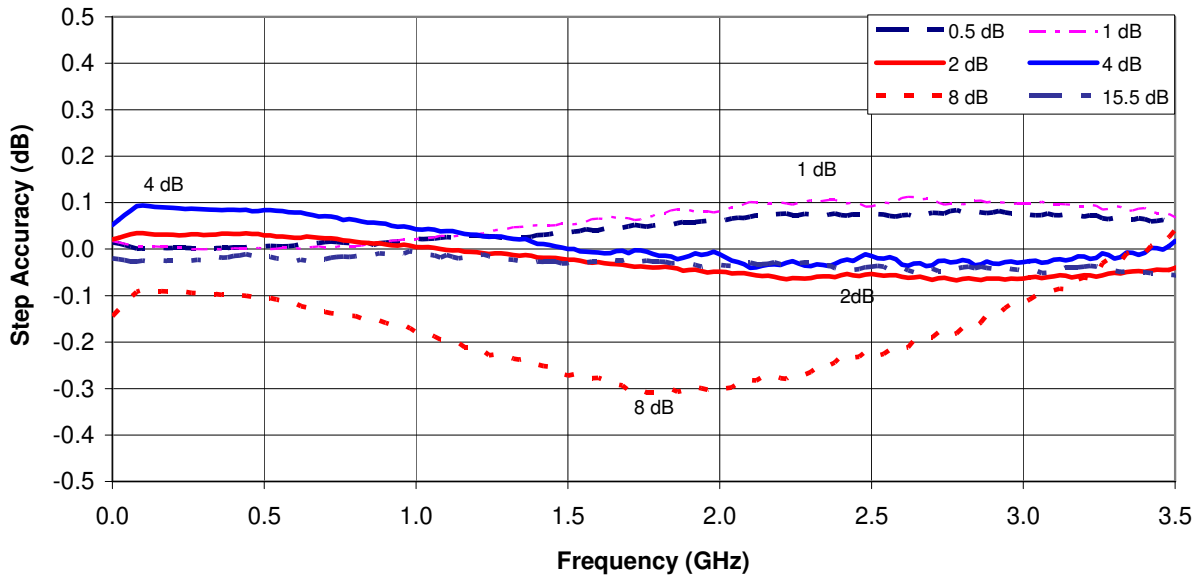

Relative Accuracy

Typical AT4510 Relative Accuracy

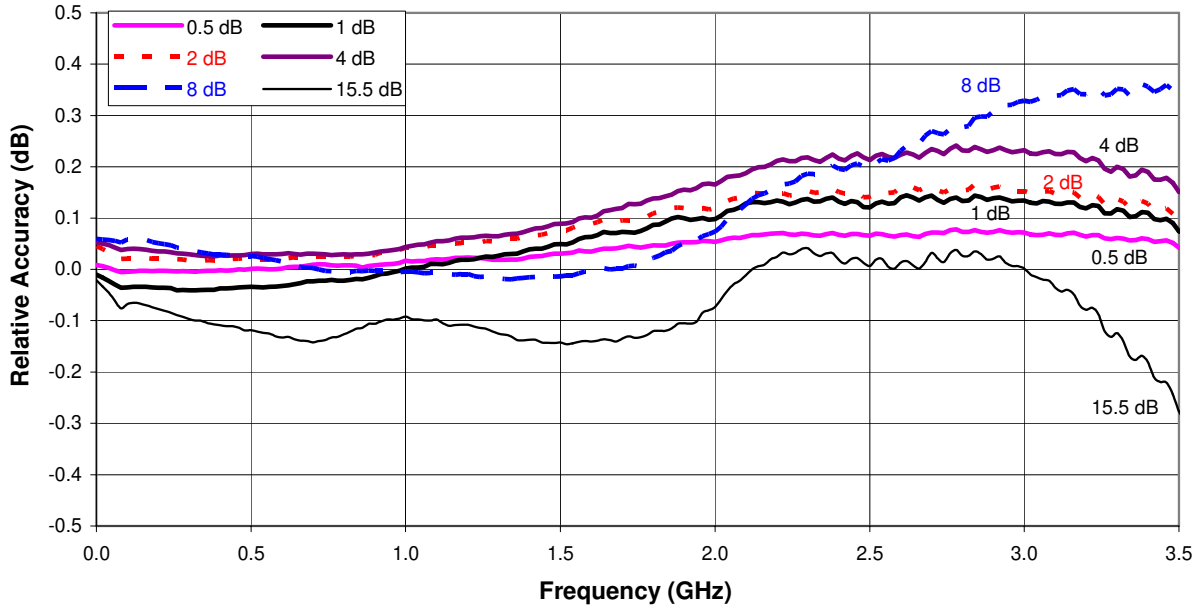

HRF-AT4510

PACKAGE OUTLINE DRAWING

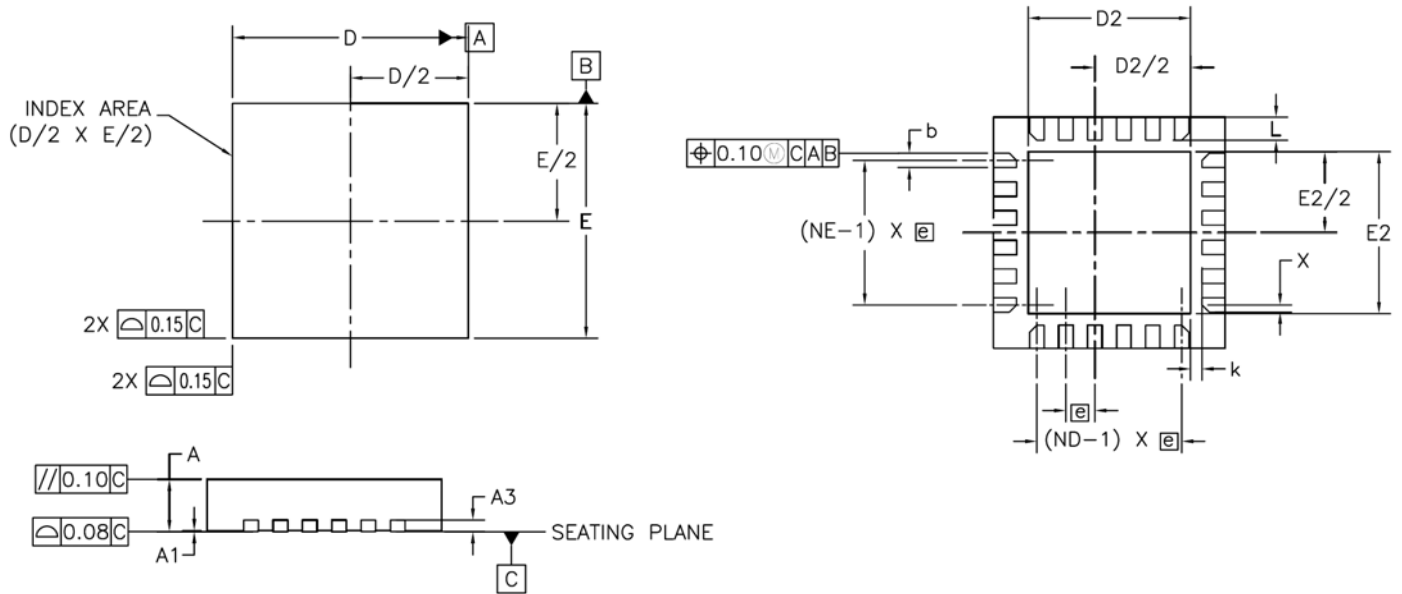

SYMBOL	VARIATION	MIN	NOM	MAX
A		0.80	0.90	1.00
A1		0	0.02	0.05
A3		---	0.20 REF	---
e		0.50	BSC	
b		0.23	0.25	0.28
D		3.90	4.00	4.10
E		3.90	4.00	4.10
D2		2.70	2.80	2.90
E2		2.70	2.80	2.90
k		0.20	---	---
L		0.35	0.40	0.45
N			24	
ND			6	
NE			6	
X		b/2	---	---

NOTES

1. Pin 1 ID can be a combination of a dot and/or chamfer.
2. Dimensions are in millimeters.

LEAD FINISH

The package leads are Tin Lead (SnPb).

CIRCUIT APPLICATION INFORMATION

These attenuators require a DC reference to ground. They may not operate properly when AC coupled on both the RF input and output without a DC ground reference provided as part of the circuit. See Application Note AN311 at www.honeywell.com/microwave.

HRF-AT4510

EVALUATION CIRCUIT BOARD

Honeywell's evaluation board provides an easy to use method of evaluating the RF performance of our attenuator. Simply connect power, DC and RF signals to be measuring attenuator performance in less than 10 minutes.



HRF-AT4510 Evaluation Board

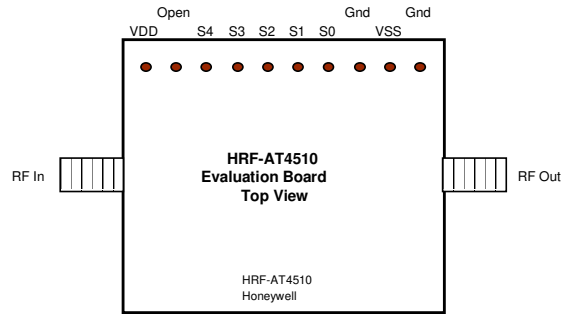

EVALUATION CIRCUIT BOARD LAYOUT DESIGN DETAILS

Item	Description
PCB	Impedance Matched Multi-Layer FR4
Attenuator	HRF-AT4510 Digital Attenuator
Chip Capacitor	Panasonic Model ECU-E1C103KBQ Capacitor, .01uf 0402 10% 16V
RF Connector	Johnson Connectors Model 142-0701-801 SMA RF Coaxial Connector
DC Pin	Mil-Max Model 800-10-064-10-001 Header Pins

ORDERING INFORMATION

Ordering Number	Delivery Method	Units Per Shipment
HRF-AT4510-TR	Tape & Reel	3000 Units Per Reel
HRF-AT4510-T	Tape	<3000
HRF-AT4510-E	Evaluation Board	One Board Per Box

FIND OUT MORE

For more information on Honeywell's Microwave Products visit us online at www.honeywell.com/microwave or contact us at 800-323-8295 (763-954-2474 internationally).

Honeywell reserves the right to make changes to improve reliability, function or design. Honeywell does not assume any liability arising out of the application or use of any product or circuit described herein; neither does it convey any license under its patent rights nor the rights of others.