

Peak Emission Wavelength: 340nm

The MTSM340UV2-F5120 is a deep ultraviolet light emitting diode with peak emission wavelengths from 340nm to 350nm. The LED is sealed in a ceramic package with UV stable encapsulation. It incorporates state of the art surface mount device (SMD) design and low thermal resistance.

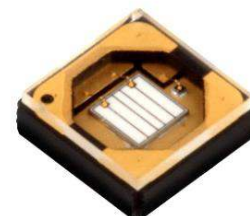

FEATURES

- > Deep ultraviolet LED
- > Low thermal resistance
- > SMT solderable

APPLICATIONS

- > Disinfection
- > Fluorescent spectroscopy
- > Chemical and Biological Analysis

Absolute Maximum Ratings (Ts=25°C, RH=30%)



ITEMS	SYMBOL	RATINGS	UNIT
Forward Current	If	350	mA
Junction Temperature	Tj	95	°C
Storage Temperature	Tstg	-40 to 100	°C

Note: Also available on PCB - Star Board MTSM340UV2-F5120S

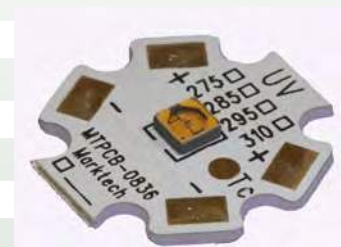

Electrical & Optical Characteristics (Ta = 25°C)

ITEMS	SYMBOL	CONDITION	VALUE	UNIT
Peak Wavelength [1]	λ_p	IF=250mA	345	nm
Radiant Flux [2]	Φ_e [3]	IF=250mA	40	mW
Forward Voltage [4]	Vf	IF=250mA	4.1	V
Spectrum Half Width	$\Delta\lambda$	IF=250mA	10	nm
Radiation Angle	Θ	IF=250mA	115	deg
Thermal Resistance [5]	R Θ J-S	--	8.5	°C/W

Notes:

- [1] Peak wavelength measurement tolerance is ± 3 nm
- [2] **Radiant Flux Measurement** tolerance is $\pm 10\%$
- [3] Φ_e is the Total Radiant Flux as measured with an integrating sphere.
- [4] Forward voltage measurement tolerance is $\pm 3\%$
- [5] R Θ J-S is the thermal resistance between chip junction to solder. Cathode solder joint was used as a measurement of solder joint temperature(Ts).
- [6] The exposure to the absolute maximum rated conditions may affect device reliability

Top View

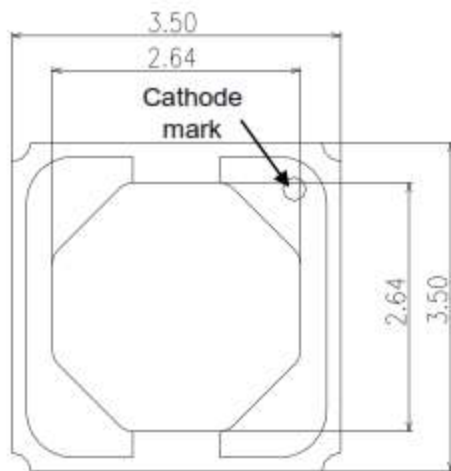

Bottom View

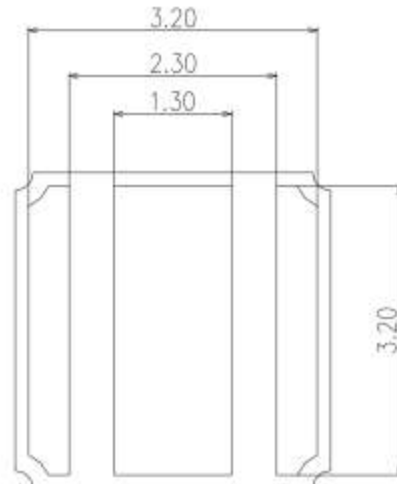

Side View



Circuit

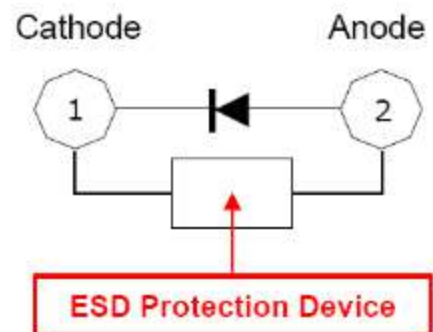

Notes :

1. All dimensions are in millimeters.
2. Scale : none
3. Undefined tolerance is $\pm 0.2\text{mm}$

1. Spectrum, $T_s=25^\circ\text{C}$, $I_f=0.25\text{A}$

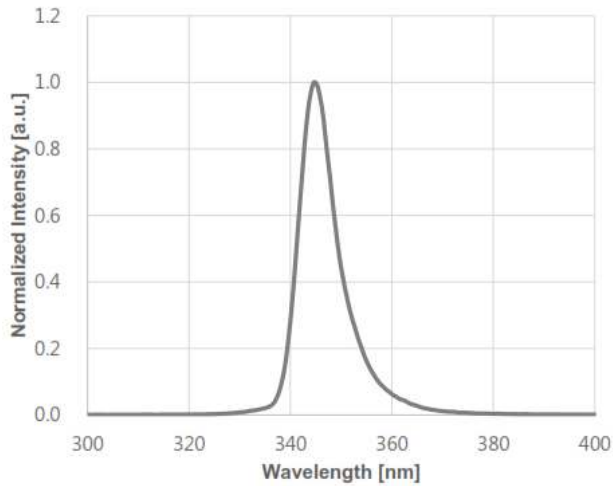

2. Forward Current vs. Forward Voltage, $T_s=25^\circ\text{C}$

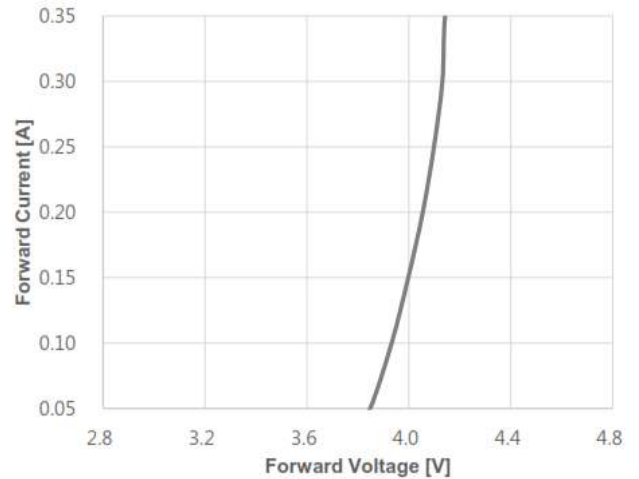

3. Relative Radiant Flux vs. Forward Current, $T_s=25^\circ\text{C}$

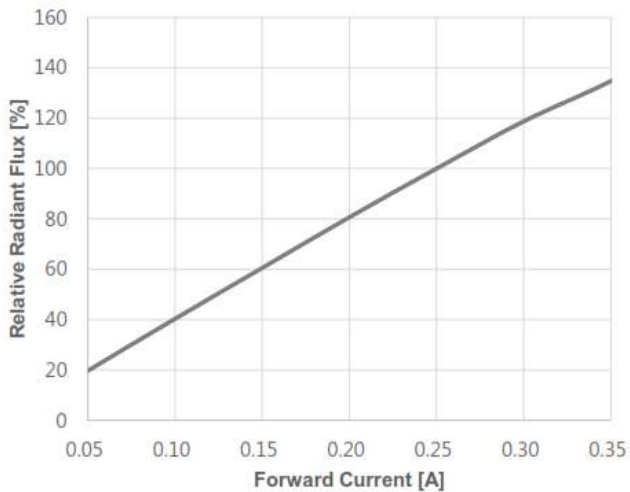

4. Peak Wavelength vs. Forward Current, $T_s=25^\circ\text{C}$

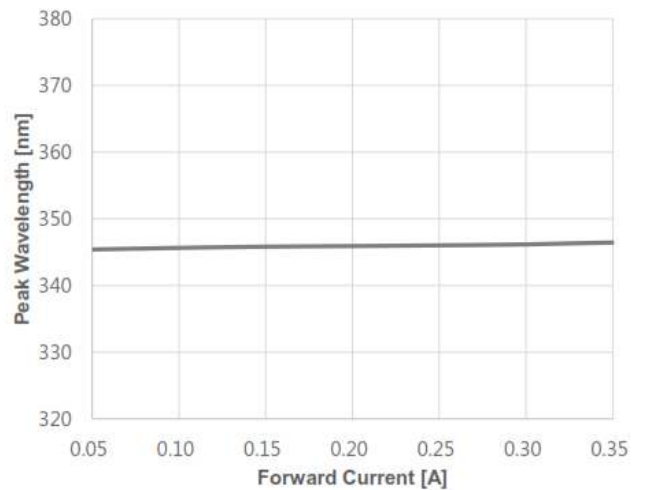

5. Relative Radiant Flux vs. Solder Joint Temp(T_s), $I_f=0.25A$

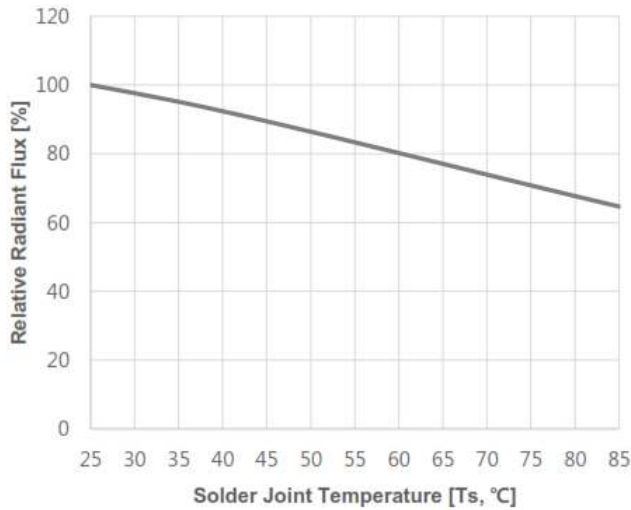

6. Peak Wavelength vs. Solder Joint Temp(T_s), $I_f=0.25A$

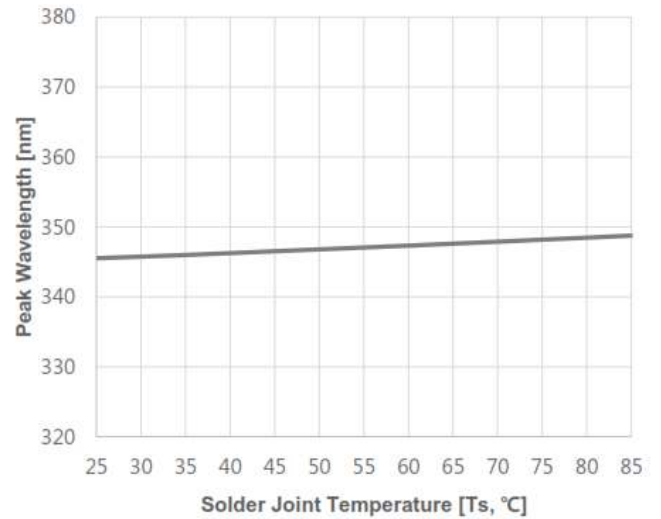

7. Forward Voltage vs. Ambient Temperature(T_s), $I_f=0.25A$

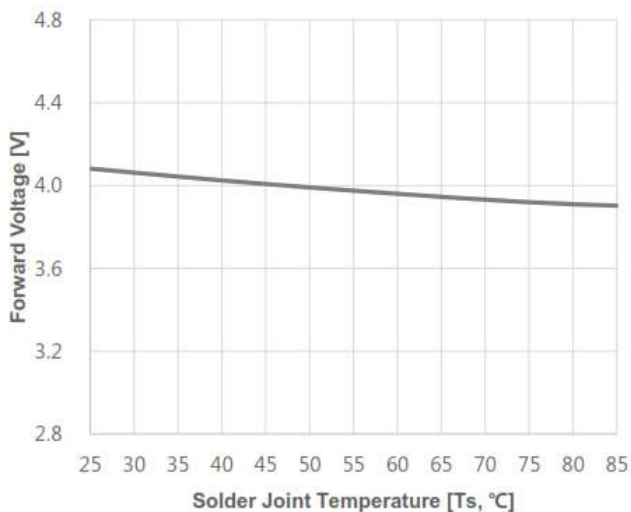

8. Typical Spatial Distribution, $I_f=0.25A$

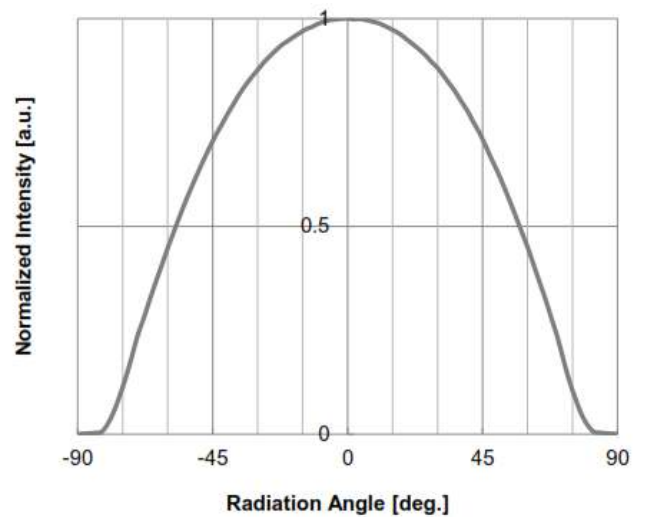

9. Maximum Forward Current vs. Solder Joint Temperature(T_s), $T_{j_{max}} = 95^{\circ}\text{C}$

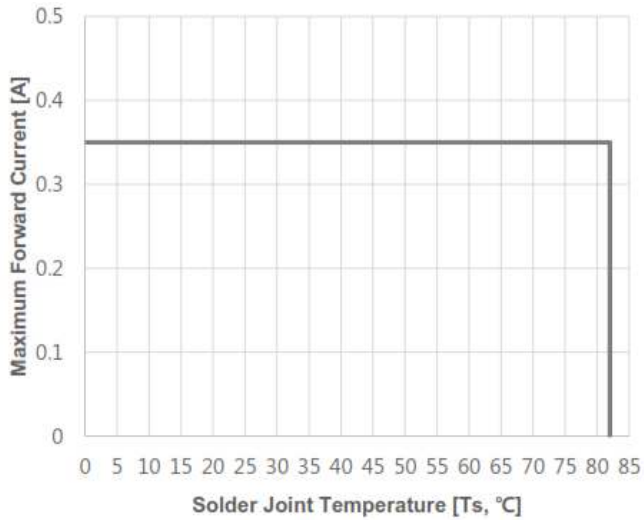

Recommended Solder Pad

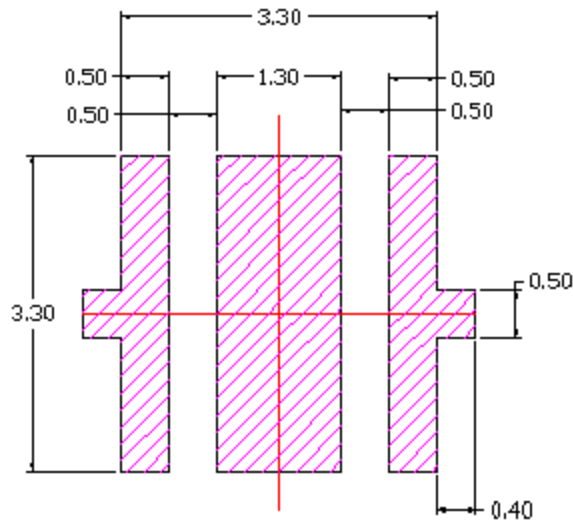

Recommended PCB Solder Pad

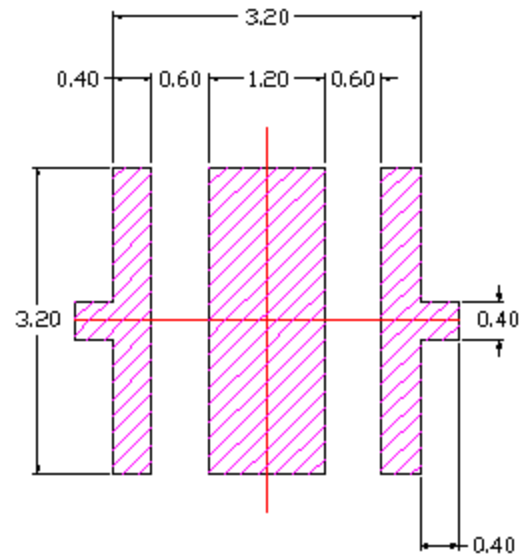

Recommended Stencil Pattern

Notes :

1. All dimensions are in millimeters.
2. Scale : none
3. Undefined tolerance is $\pm 0.2\text{mm}$
4. This drawing is without tolerance. It is for reference only
5. Be careful not to get flux on the led in the usage of flux.

Reflow Soldering Characteristics

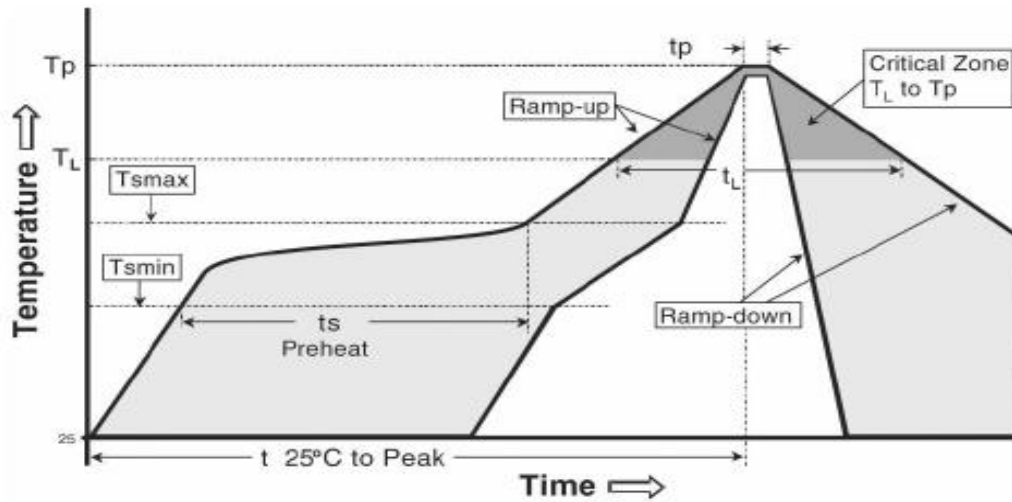

Profile Feature	Sn-Pb Eutectic Assembly	Pb-Free Assembly
Average ramp-up rate ($T_{s_{max}}$ to T_p)	3°C/second max.	3°C/second max.
Preheat - Temperature Min ($T_{s_{min}}$) - Temperature Max ($T_{s_{max}}$) - Time ($T_{s_{min}}$ to $T_{s_{max}}$) (t_s)	100 °C 150 °C 60-120 seconds	150 °C 200 °C 60-180 seconds
Time maintained above: - Temperature (T_L) - Time (t_L)	183 °C 60-150 seconds	217 °C 60-150 seconds
Peak Temperature (T_p)	215 °C	260 °C
Time within 5°C of actual Peak Temperature (t_p)	10-30 seconds	20-40 seconds
Ramp-down Rate	6 °C/second max.	6 °C/second max.
Time 25°C to Peak Temperature	6 minutes max.	8 minutes max.

Caution

1. Reflow soldering is not recommended to be done more than twice. In the case of second soldering it should be done within 24 hours after first soldering.
2. Die slug should be soldered.
3. Do not put a stress on the LEDs during soldering.
4. Do not bend the circuit board after soldering.

The information contained herein is subject to change without notice.

2021-06-22

Precaution for Use

(1) Storage

To avoid the moisture penetration, we recommend storing LEDs in a dry box with a desiccant . The recommended storage temperature range is 5°C to 30°C and a maximum humidity of RH50%.

(2) Use Precaution after Opening the Packaging

Use proper SMD techniques when the LED is to be soldered dipped as separation of the lens may affect the light output efficiency.

Pay attention to the following:

- a. Recommend conditions after opening the package
 - Sealing / Temperature : 5 ~ 30°C Humidity : less than RH60%
- b. If the package has been opened more than 7days (MSL 3) or the color of the desiccant changes, components should be dried for 10-24hr at 65±5°C
- c. Baking should only be done once.

(3) Do not apply mechanical force or excess vibration during the cooling process to normal temperature after soldering.

(4) Do not rapidly cool device after soldering.

(5) Components should not be mounted on warped (non coplanar) portion of PCB.

(6) Radioactive exposure is not considered for the products listed here in.

(7) This device should not be used in any type of fluid such as water, oil, organic solvent and etc.

(8) When the LEDs are in operation the maximum current should be decided after measuring the package temperature.

(9) LEDs must be stored in a clean environment. We recommend LEDs store in nitrogen-filled container.

(10) The appearance and specifications of the product may be modified for improvement without notice.

Precaution for Use

(11) VOCs (Volatile organic compounds) emitted from materials used in the construction of fixtures can penetrate silicone encapsulants of LEDs and discolor when exposed to heat and photonic energy. The result can be a significant loss of light output from the fixture. Knowledge of the properties of the materials selected to be used in the construction of fixtures can help prevent these issues.

(12) The slug is electrically isolated.

(13) Attaching LEDs, do not use adhesives that outgas organic vapor.

(14) The driving circuit must be designed to allow forward voltage only when it is ON or OFF. If the reverse voltage is applied to LED, migration can be generated resulting in LED damage.

(15) LEDs are sensitive to Electro-Static Discharge (ESD) and Electrical Over Stress (EOS). Below is a list of suggestions that Seoul Viosys purposes to minimize these effects.

a. ESD (Electro Static Discharge)

Electrostatic discharge (ESD) is defined as the release of static electricity when two objects come into contact. While most ESD events are considered harmless, it can be an expensive problem in many industrial environments during production and storage. The damage from ESD to LEDs may cause the product to demonstrate unusual characteristics such as:

- Increase in reverse leakage current lowered turn-on voltage
- Abnormal emissions from the LED at low current

The following recommendations are suggested to help minimize the potential for an ESD event. One or more recommended work area suggestions:

- Ionizing fan setup
- ESD table/shelf mat made of conductive materials
- ESD safe storage containers

One or more personnel suggestion options:

- Antistatic wrist-strap
- Antistatic material shoes
- Antistatic clothes

Environmental controls:

- Humidity control (ESD gets worse in a dry environment)

Precaution for Use

b. EOS (Electrical Over Stress)

Electrical Over-Stress (EOS) is defined as damage that may occur when an electronic device is subjected to a current or voltage that is beyond the maximum specification limits of the device. The effects from an EOS event can be noticed through product performance like:

- Changes to the performance of the LED package
(If the damage is around the bond pad area and since the package is completely encapsulated the package may turn on but flicker show severe performance degradation.)
- Changes to the light output of the luminaire from component failure
- Components on the board not operating at determined drive power

Failure of performance from entire fixture due to changes in circuit voltage and current across total circuit causing trickle down failures. It is impossible to predict the failure mode of every LED exposed to electrical overstress as the failure modes have been investigated to vary, but there are some common signs that will indicate an EOS event has occurred:

- Damaged may be noticed to the bond wires (appearing similar to a blown fuse)
- Damage to the bond pads located on the emission surface of the LED package
(shadowing can be noticed around the bond pads while viewing through a microscope)
- Anomalies noticed in the encapsulation and phosphor around the bond wires.
- This damage usually appears due to the thermal stress produced during the EOS event.

c. To help minimize the damage from an EOS event Seoul Viosys recommends utilizing:

- A surge protection circuit
- An appropriately rated over voltage protection device
- A current limiting device

Attach the following warning labels on products/systems that use UV LEDs.

