

## YASMEEN-70-W-C

~36° wide beam. Assembly with holder C compatible with LEDiL HEKLA. Black version.

### SPECIFICATION:

Dimensions	Ø 69.9 mm
Height	39.9 mm
ROHS compliant	yes ⓘ

### MATERIALS:

Component	Type	Material	Colour	Finish
YASMEEN-70-W	Single lens	PMMA	clear	
YASMEEN-70-HLD-C	Holder C	PC	black	

### ORDERING INFORMATION:





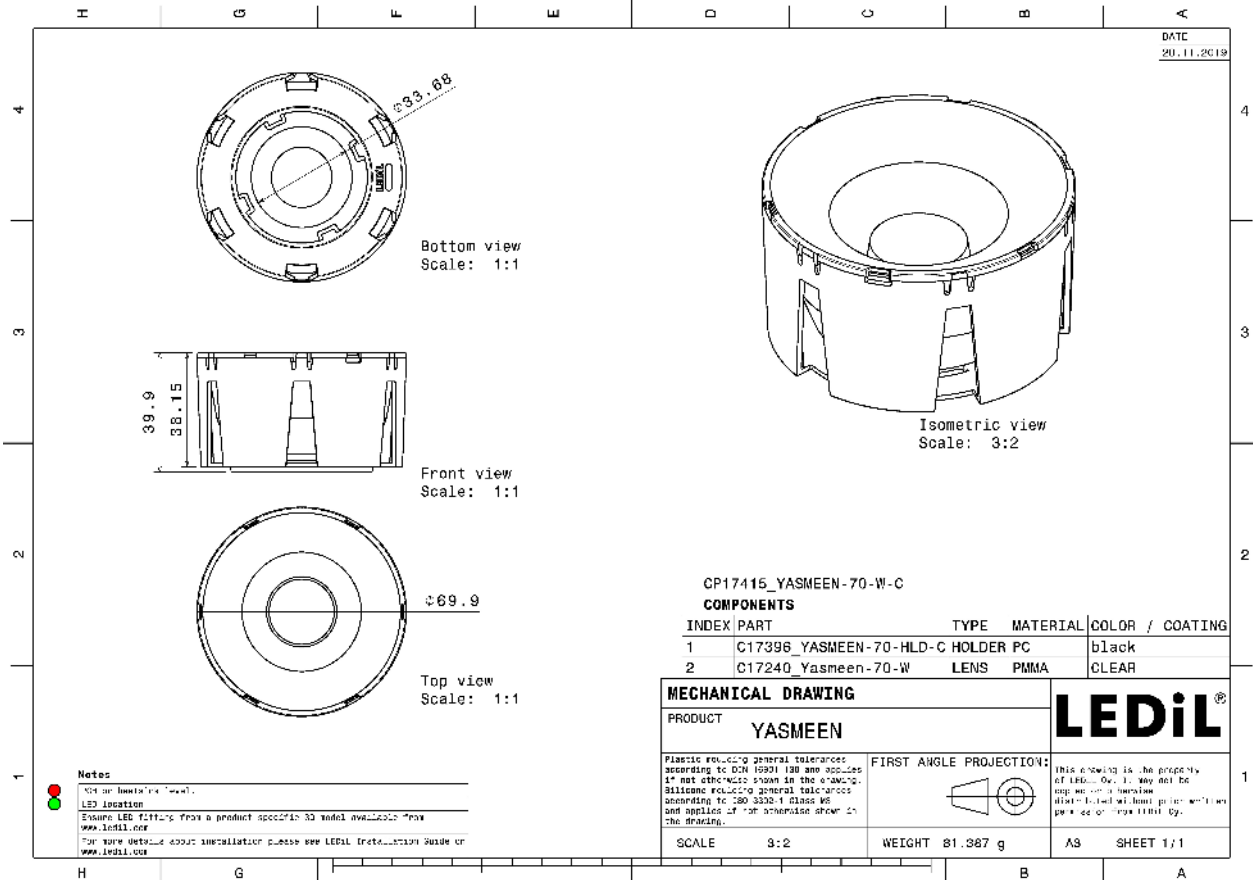



Component	Type	Qty in box	MOQ	MPQ	Box weight (kg)
CP17415_YASMEEN-70-W-C » Box size: 476 x 273 x 305 mm	Single lens	105	105	15	10.0



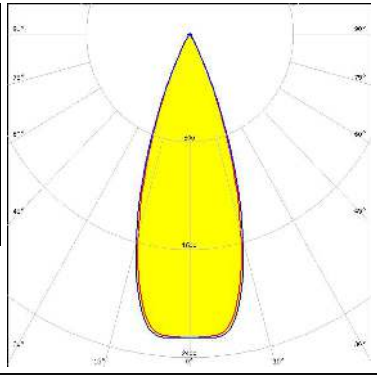

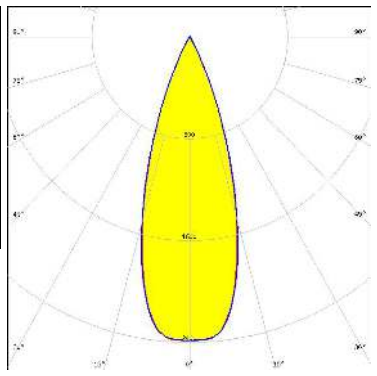

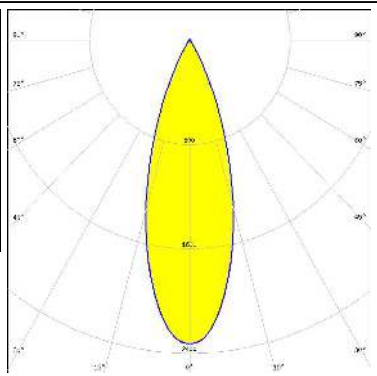

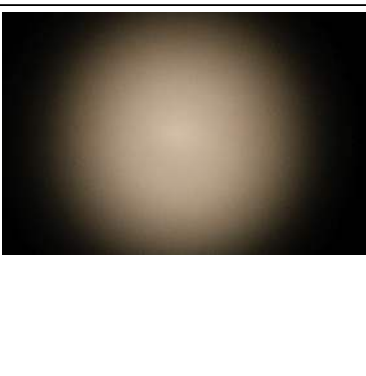
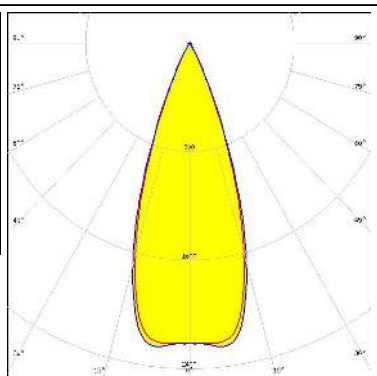



See also our general installation guide: [www.ledil.com/installation\\_guide](http://www.ledil.com/installation_guide)

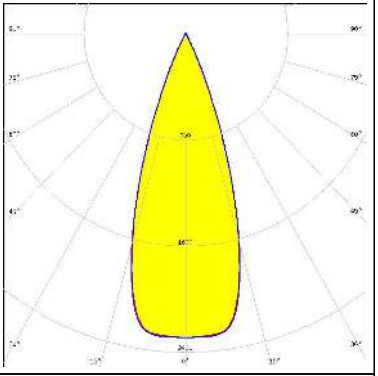

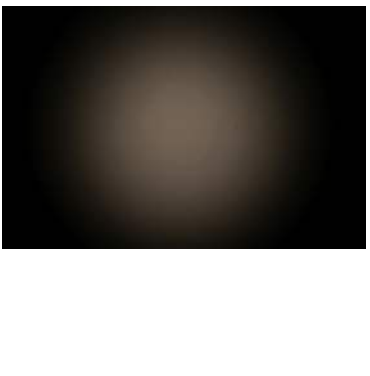
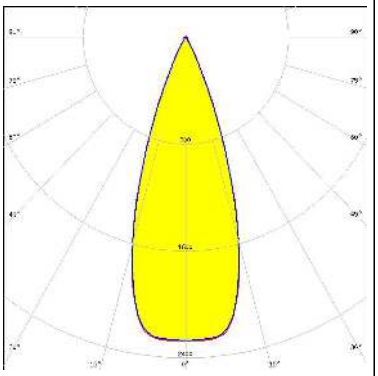

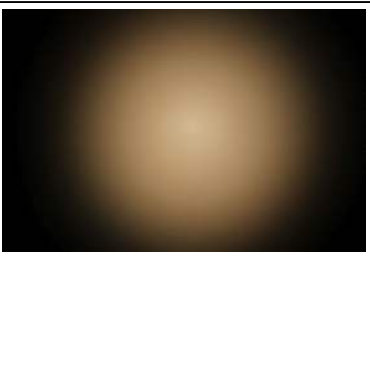
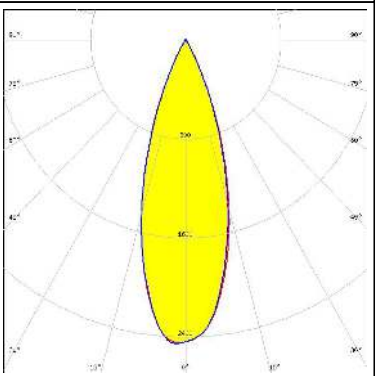

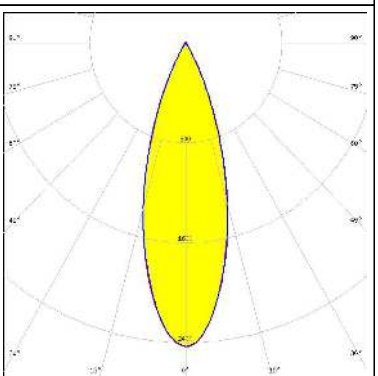
#### OPTICAL RESULTS (MEASURED):

<p></p> <p>LED V10 Gen 8            FWHM / FWTM 37.0° / 54.0°            Efficiency 87 %            Peak intensity 2.3 cd/lm            LEDs/each optic 1            Light colour White            Required components:            F15255_HEKLA-SOCKET-C</p>		
<p></p> <p>LED V11 HD Gen 8            FWHM / FWTM 35.0° / 53.0°            Efficiency 85 %            Peak intensity 2.4 cd/lm            LEDs/each optic 1            Light colour White            Required components:            Bender Wirth: 633d Hekla</p>		
<p></p> <p>LED V13 Gen 8            FWHM / FWTM 34.0° / 57.0°            Efficiency 84 %            Peak intensity 2.3 cd/lm            LEDs/each optic 1            Light colour White            Required components:            F15859_HEKLA-SOCKET-I</p>		
<p></p> <p>LED V8 Gen 8            FWHM / FWTM 37.0° / 54.0°            Efficiency 88 %            Peak intensity 2.3 cd/lm            LEDs/each optic 1            Light colour White            Required components:            F15253_HEKLA-SOCKET-A</p>		

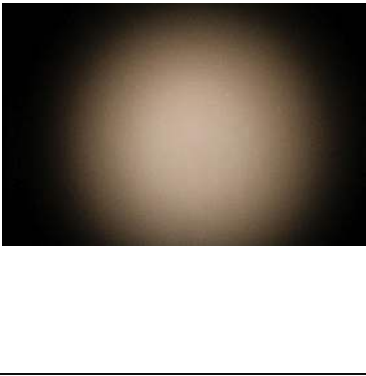
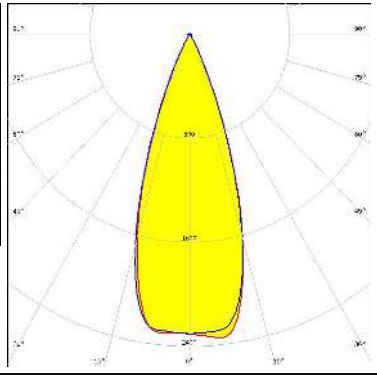

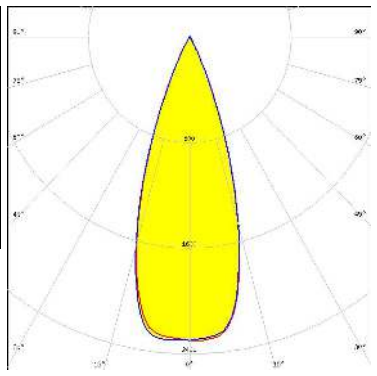

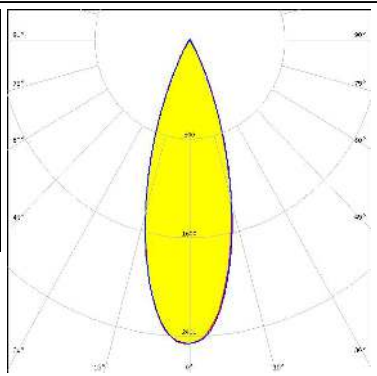
#### OPTICAL RESULTS (MEASURED):

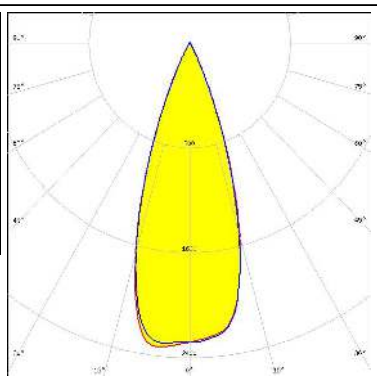
<p></p> <p>LED V9 HD Gen7</p> <p>FWHM / FWTM 36.0° / 51.0°</p> <p>Efficiency 84 %</p> <p>Peak intensity 2.3 cd/m</p> <p>LEDs/each optic 1</p> <p>Light colour White</p> <p>Required components: F15859_HEKLA-SOCKET-I</p>		
<p></p> <p>LED VERO10</p> <p>FWHM / FWTM 37.0° / 53.0°</p> <p>Efficiency 85 %</p> <p>Peak intensity 2.3 cd/m</p> <p>LEDs/each optic 1</p> <p>Light colour White</p> <p>Required components: F15616_HEKLA-SOCKET-F</p>		
<p></p> <p>LED Vesta DTW 13mm (21W)</p> <p>FWHM / FWTM 34.0° / 55.0°</p> <p>Efficiency 85 %</p> <p>Peak intensity 2.5 cd/m</p> <p>LEDs/each optic 1</p> <p>Light colour Tunable White</p> <p>Required components: Bender Wirth: 632b Hekla XL</p>		
<p></p> <p>LED Vesta DTW 15mm (33W)</p> <p>FWHM / FWTM 33.0° / 56.0°</p> <p>Efficiency 84 %</p> <p>Peak intensity 2.4 cd/m</p> <p>LEDs/each optic 1</p> <p>Light colour Tunable White</p> <p>Required components: Bender Wirth: 632b Hekla XL</p>		

#### OPTICAL RESULTS (MEASURED):

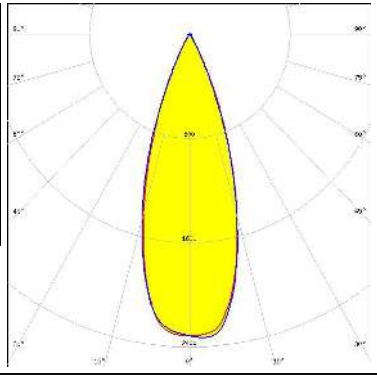
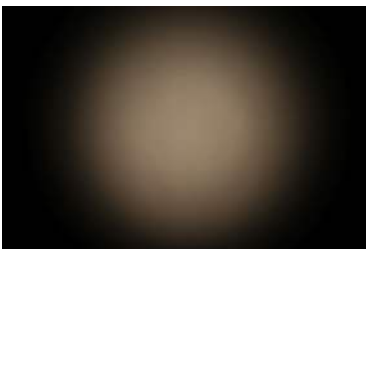
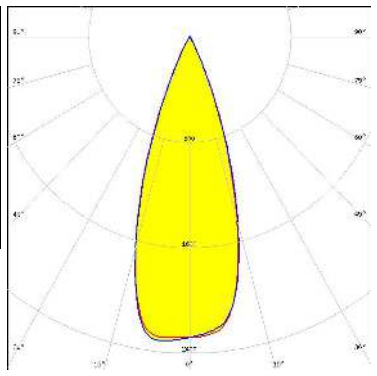

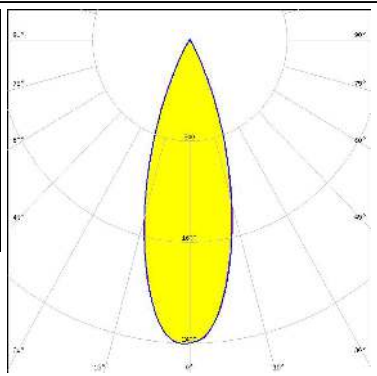

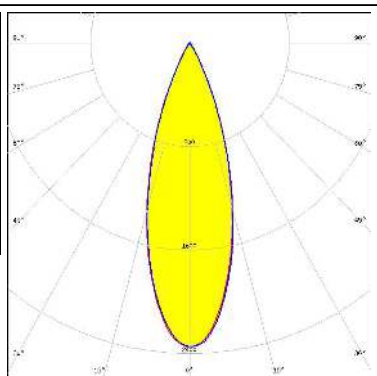
<p></p> <p>LED Vesta DTW 9mm (4W/6W/12W)            FWHM / FWTM 37.0° / 53.0°            Efficiency 86 %            Peak intensity 2.3 cd/m            LEDs/each optic 1            Light colour White            Required components:            Bender Wirth: 652b Hekla</p>		
<p><b>CITIZEN</b></p> <p>LED CLL02x/CLU02x (LES10)            FWHM / FWTM 36.0° / 52.0°            Efficiency 84 %            Peak intensity 2.3 cd/m            LEDs/each optic 1            Light colour White            Required components:            F17435_HEKLA-G2-C</p>		
<p><b>CITIZEN</b></p> <p>LED CLL03x/CLU03x            FWHM / FWTM 33.0° / 54.5°            Efficiency 84 %            Peak intensity 2.5 cd/m            LEDs/each optic 1            Light colour White            Required components:            F17438_HEKLA-G2-I</p>		
<p></p> <p>LED CMA1516            FWHM / FWTM 36.0° / 52.0°            Efficiency 84 %            Peak intensity 2.3 cd/m            LEDs/each optic 1            Light colour White            Required components:            F17436_HEKLA-G2-D</p>		

#### OPTICAL RESULTS (MEASURED):

<p><b>CREE</b> ⇄ <b>LED</b></p> <p>LED CMA1825            FWHM / FWTM 35.0° / 55.0°            Efficiency 85 %            Peak intensity 2.3 cd/lm            LEDs/each optic 1            Light colour White            Required components:            F15254_HEKLA-SOCKET-B</p>		
<p><b>CREE</b> ⇄ <b>LED</b></p> <p>LED CMT14xx            FWHM / FWTM 36.0° / 53.0°            Efficiency 84 %            Peak intensity 2.3 cd/lm            LEDs/each optic 1            Light colour White            Required components:            F17435_HEKLA-G2-C</p>		
<p><b>CREE</b> ⇄ <b>LED</b></p> <p>LED CMT19xx            FWHM / FWTM 33.0° / 54.0°            Efficiency 83 %            Peak intensity 2.4 cd/lm            LEDs/each optic 1            Light colour White            Required components:            F17438_HEKLA-G2-I</p>		
<p><b>CREE</b> ⇄ <b>LED</b></p> <p>LED CMU15xx            FWHM / FWTM 33.0° / 56.0°            Efficiency 83 %            Peak intensity 2.3 cd/lm            LEDs/each optic 1            Light colour White            Required components:            F17438_HEKLA-G2-I</p>		

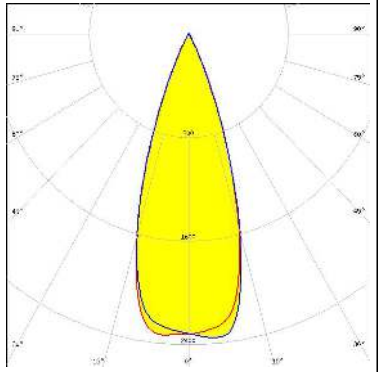

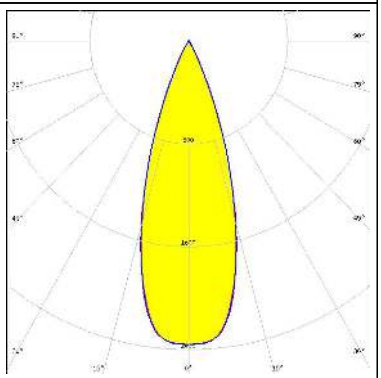
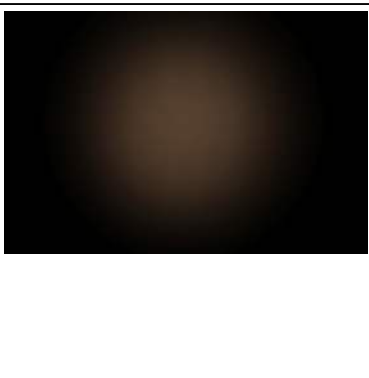
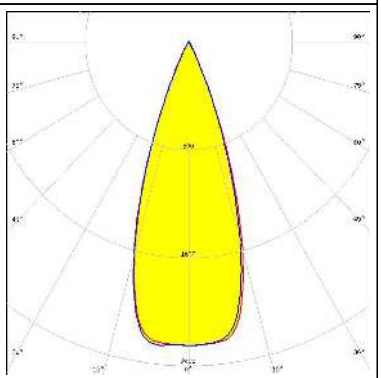
#### OPTICAL RESULTS (MEASURED):

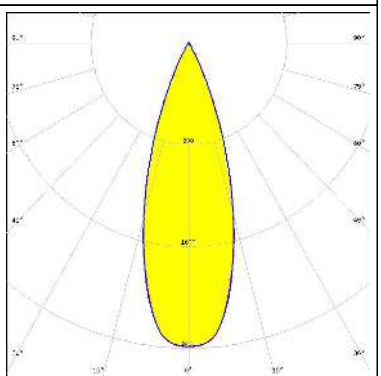
<p><b>LUMILEDS</b></p> <p>LED LUXEON CoB 1202/1203</p> <p>FWHM / FWTM 36.0° / 52.0°</p> <p>Efficiency 84 %</p> <p>Peak intensity 2.4 cd/m</p> <p>LEDs/each optic 1</p> <p>Light colour White</p> <p>Required components: F17437_HEKLA-G2-H</p>		
<p><b>NICHIA</b></p> <p>LED COB L-Type (LES 11)</p> <p>FWHM / FWTM 34.0° / 53.0°</p> <p>Efficiency 83 %</p> <p>Peak intensity 2.4 cd/m</p> <p>LEDs/each optic 1</p> <p>Light colour White</p> <p>Required components: F17437_HEKLA-G2-H</p>		
<p><b>NICHIA</b></p> <p>LED COB L-Type (LES 9)</p> <p>FWHM / FWTM 36.0° / 52.0°</p> <p>Efficiency 83 %</p> <p>Peak intensity 2.3 cd/m</p> <p>LEDs/each optic 1</p> <p>Light colour White</p> <p>Required components: F17437_HEKLA-G2-H</p>		
<p><b>NICHIA</b></p> <p>LED COB S-Type (LES 7)</p> <p>FWHM / FWTM 34.0° / 54.0°</p> <p>Efficiency 83 %</p> <p>Peak intensity 2.4 cd/m</p> <p>LEDs/each optic 1</p> <p>Light colour White</p> <p>Required components: F17438_HEKLA-G2-I</p>		

#### OPTICAL RESULTS (MEASURED):

### PHILIPS

LED Fortimo SLM L09 CoB  
 FWHM / FWTM 36.0° / 52.0°  
 Efficiency 84 %  
 Peak intensity 2.4 cd/lm  
 LEDs/each optic 1  
 Light colour White  
 Required components:  
 F17437\_HEKLA-G2-H

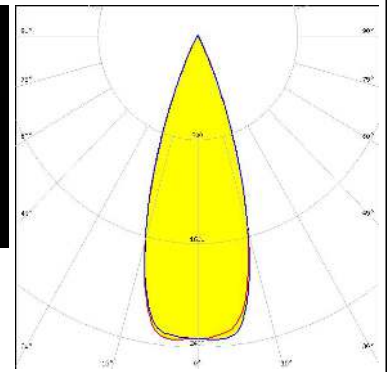

### SAMSUNG

LED LC016D / LC019D / LC026D / LC033D  
 FWHM / FWTM 33.0° / 55.0°  
 Efficiency 83 %  
 Peak intensity 2.4 cd/lm  
 LEDs/each optic 1  
 Light colour White  
 Required components:  
 F17438\_HEKLA-G2-I

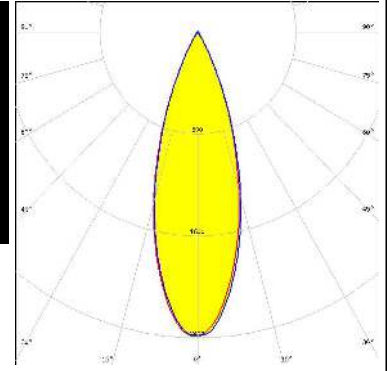

### SAMSUNG

LED LC030C/040C G2  
 FWHM / FWTM 34.0° / 53.0°  
 Efficiency 84 %  
 Peak intensity 2.4 cd/lm  
 LEDs/each optic 1  
 Light colour White  
 Required components:  
 F17438\_HEKLA-G2-I

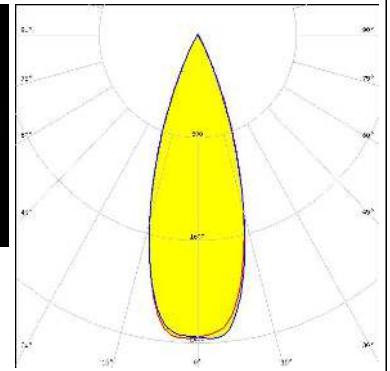
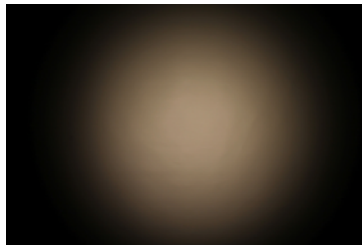

SEUL SEMICONDUCTOR  
 LED MJT COB LES 14.5  
 FWHM / FWTM 33.0° / 55.0°  
 Efficiency 83 %  
 Peak intensity 2.4 cd/lm  
 LEDs/each optic 1  
 Light colour White  
 Required components:  
 F17438\_HEKLA-G2-I

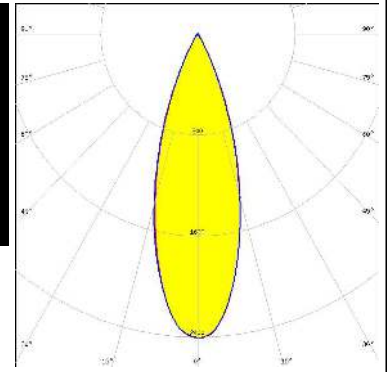
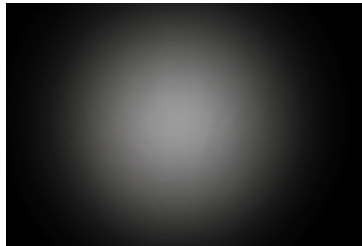



#### OPTICAL RESULTS (MEASURED):

#### TRIDONIC

LED SLE G7 LES09  
FWHM / FWTM 36.0° / 51.0°  
Efficiency 84 %  
Peak intensity 2.3 cd/lm  
LEDs/each optic 1  
Light colour White  
Required components:  
F17435\_HEKLA-G2-C

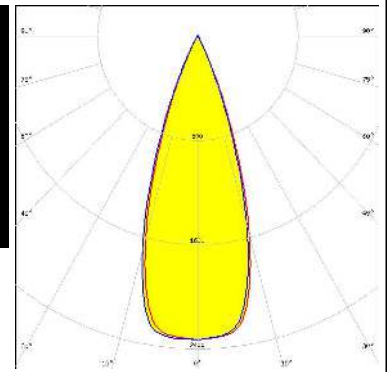
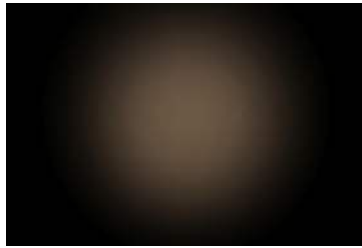



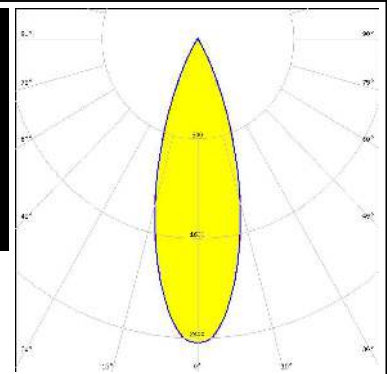
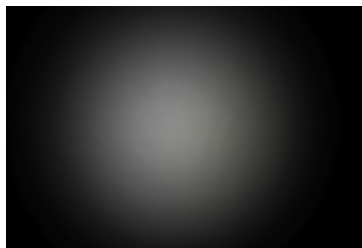

#### TRIDONIC

LED SLE G7 LES15  
FWHM / FWTM 33.0° / 55.0°  
Efficiency 84 %  
Peak intensity 2.4 cd/lm  
LEDs/each optic 1  
Light colour White  
Required components:  
F17438\_HEKLA-G2-I

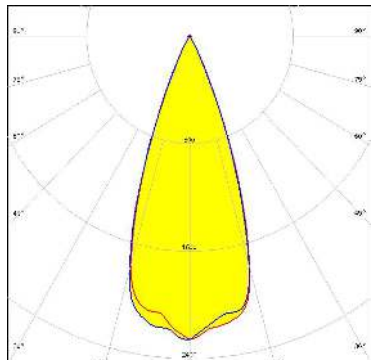
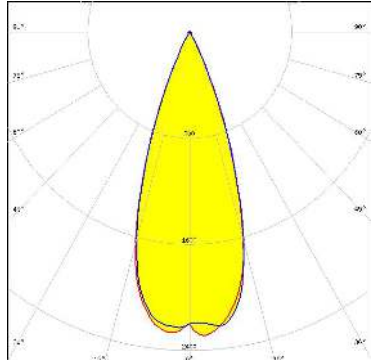

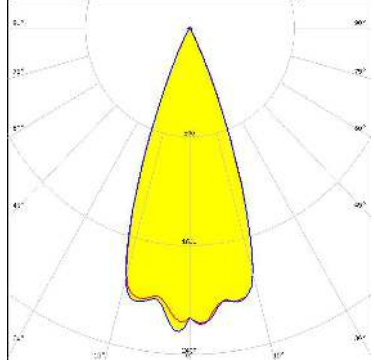
#### OPTICAL RESULTS (SIMULATED):

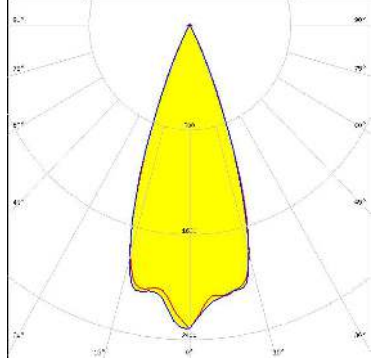
<p></p> <p>LED V6 HD Gen 7            FWHM / FWTM 38.0° / 52.0°            Efficiency 87 %            Peak intensity 2.3 cd/lm            LEDs/each optic 1            Light colour White            Required components:            F15255_HEKLA-SOCKET-C</p>	
<p><b>CITIZEN</b></p> <p>LED CLU712/713            FWHM / FWTM 38.0° / 54.0°            Efficiency 85 %            Peak intensity 2.3 cd/lm            LEDs/each optic 1            Light colour White            Required components:            F17438_HEKLA-G2-I</p>	
<p></p> <p>LED CHA0304            FWHM / FWTM 40.0° / 52.0°            Efficiency 86 %            Peak intensity 2.2 cd/lm            LEDs/each optic 1            Light colour White            Required components:            F17435_HEKLA-G2-C</p>	
<p></p> <p>LED CHA0410            FWHM / FWTM 38.0° / 52.0°            Efficiency 86 %            Peak intensity 2.3 cd/lm            LEDs/each optic 1            Light colour White            Required components:            F17435_HEKLA-G2-C</p>	

#### OPTICAL RESULTS (SIMULATED):

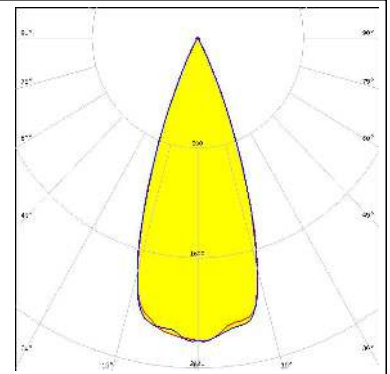
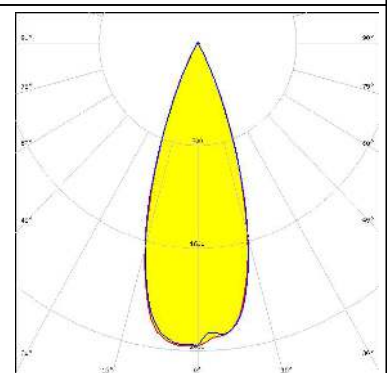
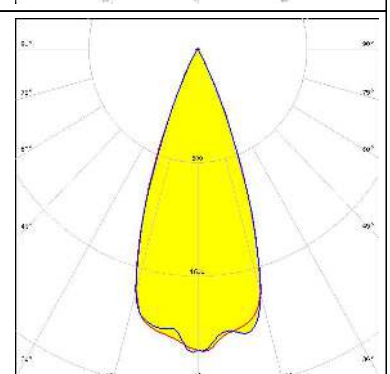
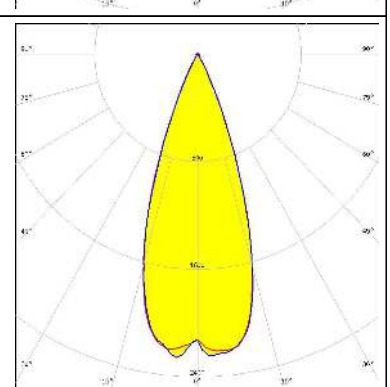
<p><b>CREE</b> ⇄ <b>LED</b></p> <p>LED: CHA0612            FWHM / FWTM: 38.0° / 52.0°            Efficiency: 86 %            Peak intensity: 2.3 cd/lm            LEDs/each optic: 1            Light colour: White            Required components:            F17435_HEKLA-G2-C</p>	
<p><b>CREE</b> ⇄ <b>LED</b></p> <p>LED: CMU10xx            FWHM / FWTM: 36.0° / 54.0°            Efficiency: 86 %            Peak intensity: 2.4 cd/lm            LEDs/each optic: 1            Light colour: White            Required components:            F17435_HEKLA-G2-C</p>	
<p><b>CREE</b> ⇄ <b>LED</b></p> <p>LED: CXA/B 13xx            FWHM / FWTM: 40.0° / 54.0°            Efficiency: 86 %            Peak intensity: 2.1 cd/lm            LEDs/each optic: 1            Light colour: White            Required components:            F17439_HEKLA-G2-J</p>	
<p><b>CREE</b> ⇄ <b>LED</b></p> <p>LED: CXA/B 15xx            FWHM / FWTM: 38.0° / 54.0°            Efficiency: 85 %            Peak intensity: 2.4 cd/lm            LEDs/each optic: 1            Light colour: White            Required components:            F17436_HEKLA-G2-D</p>	

#### OPTICAL RESULTS (SIMULATED):

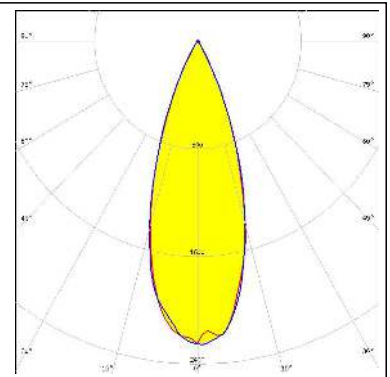
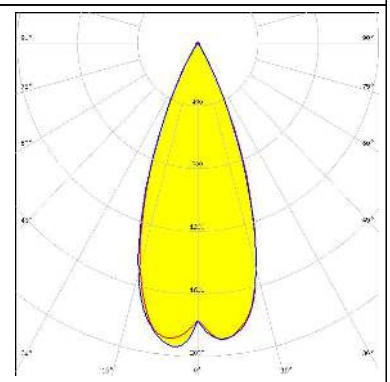
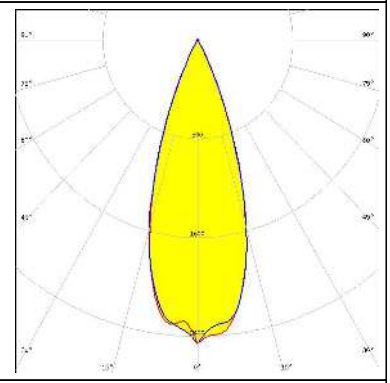
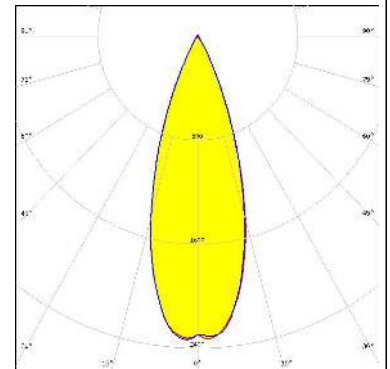
<p><b>CREE</b> LED</p> <p>LED: CXA/B 1830            FWHM / FWTM: 36.0° / 56.0°            Efficiency: 85 %            Peak intensity: 2.3 cd/lm            LEDs/each optic: 1            Light colour: White            Required components:            Bender Wirth: 637b Hekla</p>	
<p><b>NICHIA</b></p> <p>LED: NVCWJ024Z-V1MT: COB J-Type Tunable White            FWHM / FWTM: 41.0° / 58.0°            Efficiency: 86 %            Peak intensity: 2 cd/lm            LEDs/each optic: 1            Light colour: White            Required components:            C16142_HEKLA-SOCKET-K            Bender Wirth: 498 Typ L8 HV</p>	
<p><b>SAMSUNG</b></p> <p>LED: LC003D / LC006D / LC009D / LC013D            FWHM / FWTM: 36.0° / 54.0°            Efficiency: 85 %            Peak intensity: 2.5 cd/lm            LEDs/each optic: 1            Light colour: White            Required components:            F17435_HEKLA-G2-C</p>	
<p><b>TRIDONIC</b></p> <p>LED: SLE G7 LES13            FWHM / FWTM: 35.0° / 56.0°            Efficiency: 85 %            Peak intensity: 2.4 cd/lm            LEDs/each optic: 1            Light colour: White            Required components:            F17438_HEKLA-G2-I</p>	

#### GENERAL INFORMATION:

NOTE: The typical beam angle will be changed by different color, chip size and chip position tolerance. The typical total beam angle is the full angle measured where the luminous intensity is half of the peak value.

Due to use of high power COB's with this product, special attention to proper thermal design is highly recommended. LEDiL has no liability for direct, indirect or consecutive damages arising from the LEDiL products being used outside of the recommended temperature range.

#### MATERIALS:

As part of our continuous research and improvement processes, and to ensure the best possible quality and availability of our products, LEDiL reserves the right to change material grades without notice.

#### PRODUCT DATA USER AGREEMENT AND DISCLAIMER:

The measured data in the provided downloadable LEDiL Product Datasheets and Mechanical 2D-Drawings is rounded and provided as reference for planning. LEDiL Oy's optical specifications have been verified by conducting performance testing of the products in accordance with the company's quality system. The reported data are averaged results of multiple measurements with typical variation. LEDiL Oy reserves the right to without prior notification make changes and improvements to its products.

LEDiL Oy assumes neither warranty, nor guarantee nor any other liability of any kind for the contents and correctness of the provided data. The provided data has been generated with highest diligence but the provided data may in reality not represent the complete possible variation range of all intrinsic parameters. Therefore, in certain cases a deviation from the provided data could occur.

LEDiL Oy reserves the right to undertake technical changes of its products without further notification which could lead to changes in the provided data. LEDiL Oy assumes no liability of any kind for the possible deviation from any provided data or any other damage resulting from the usage of the provided data.

The user agrees to this disclaimer and user agreement with the download or usage of the provided files.

#### LEDiL Oy

Joensuunkatu 13  
FI-24240 SALO  
Finland

#### LEDiL Inc.

228 West Page Street  
Suite D  
Sycamore IL 60178  
USA

#### Ledil Optics Technology (Shenzhen) Co., Ltd.

# 405 , Block B  
Casic Motor Building  
Shenzhen 518057  
P.R.CHINA

#### Local sales and technical support

[www.ledil.com/  
where\\_to\\_buy](http://www.ledil.com/where_to_buy)

#### Shipping locations

Salo, Finland  
Hong Kong, China

#### Distribution Partners

[www.ledil.com/  
where\\_to\\_buy](http://www.ledil.com/where_to_buy)