

PRODUCT NO. 51939-941-- NOTE 3	POWER									
	E1	P1	P2	P3	P4	P5	P6	P7	P8	P9
	PA	X	X	X	PA	X	PA	X	PA	

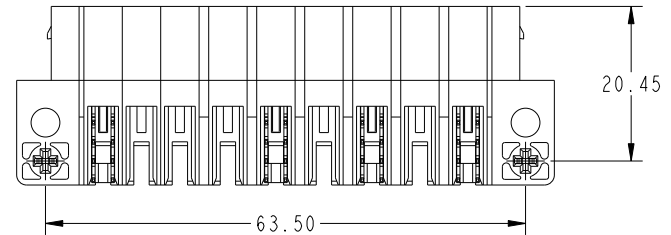

VIEW D-D

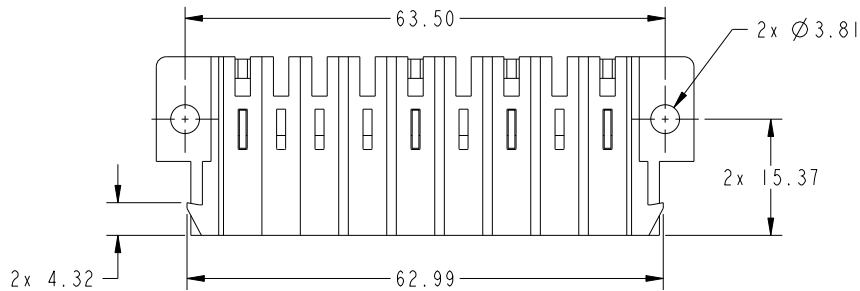
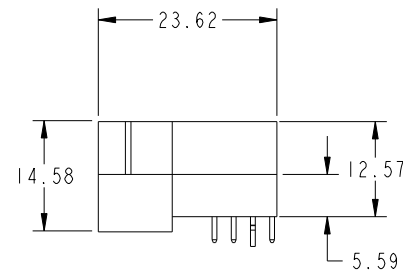
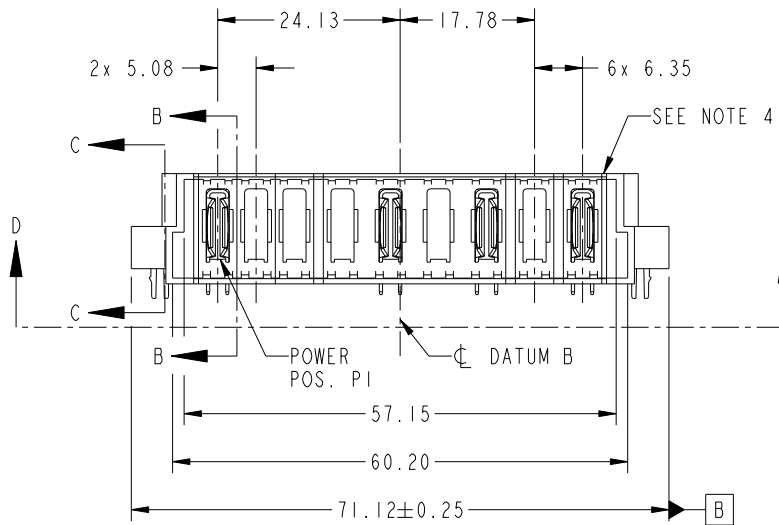

CODE	DIM "M" MATING LENGTH	CONTACT TYPE
PA	[N/A]	POWER
HA	[N/A]	HOLD-DOWN
X	OMITTED	

spec ref	*	dr	De-Ming Lu	2014/12/12	projection 	MM ←→	size	A4	scale	1:1
tolerance std	ASME Y14.5	eng	De-Ming Lu	2014/12/29			ecn no	-		
TOLERANCES UNLESS OTHERWISE SPECIFIED		chr	-	-			rel level	Released		
surface	✓	appr	Pei-Ming Zheng	2014/12/29	product family	PwrBlade	dwg no	51939-941	rev	A
ASME Y14.5	linear	0.X	±0.5	www.fci.com	title	9P RIGHT ANGLE SOLDER HEADER	cat. no.	-	Product - Customer Drw	sheet 1 of 4
		0.XX	±0.25							
		0.XXX	±0.1							
	angular	0°	±2°							

PRODUCT NUMBER

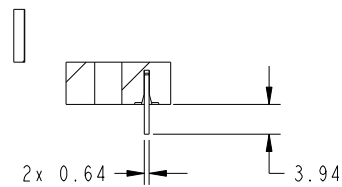

51939-941--
NOTE: 3

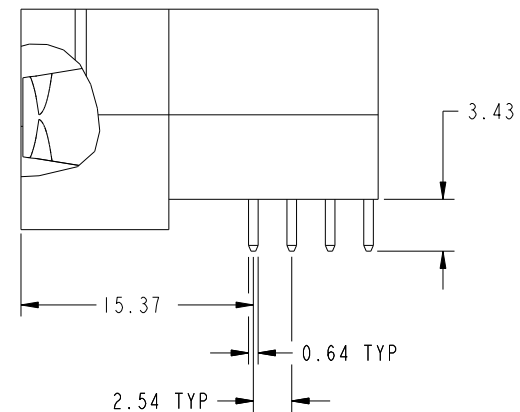

SECTION C-C

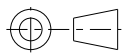
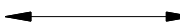

BROKEN-OUT SECTION B-B
SCALE 2:1

dr	De-Ming Lu	2014/12/12	projection 	MM 	size	A4	scale	1:1	
eng	De-Ming Lu	2014/12/29			ecn no	-			
chr	-	-			rel level	Released			
appr	Pei-Ming Zheng	2014/12/29	product family	PwrBlade					
	title	9P RIGHT ANGLE SOLDER HEADER			dwg no	51939-941		rev	A
www.fci.com	cat. no.	-	Product - Customer Drw			sheet 2 of 4			

PRODUCT NUMBER

51939-941--
NOTE: 3

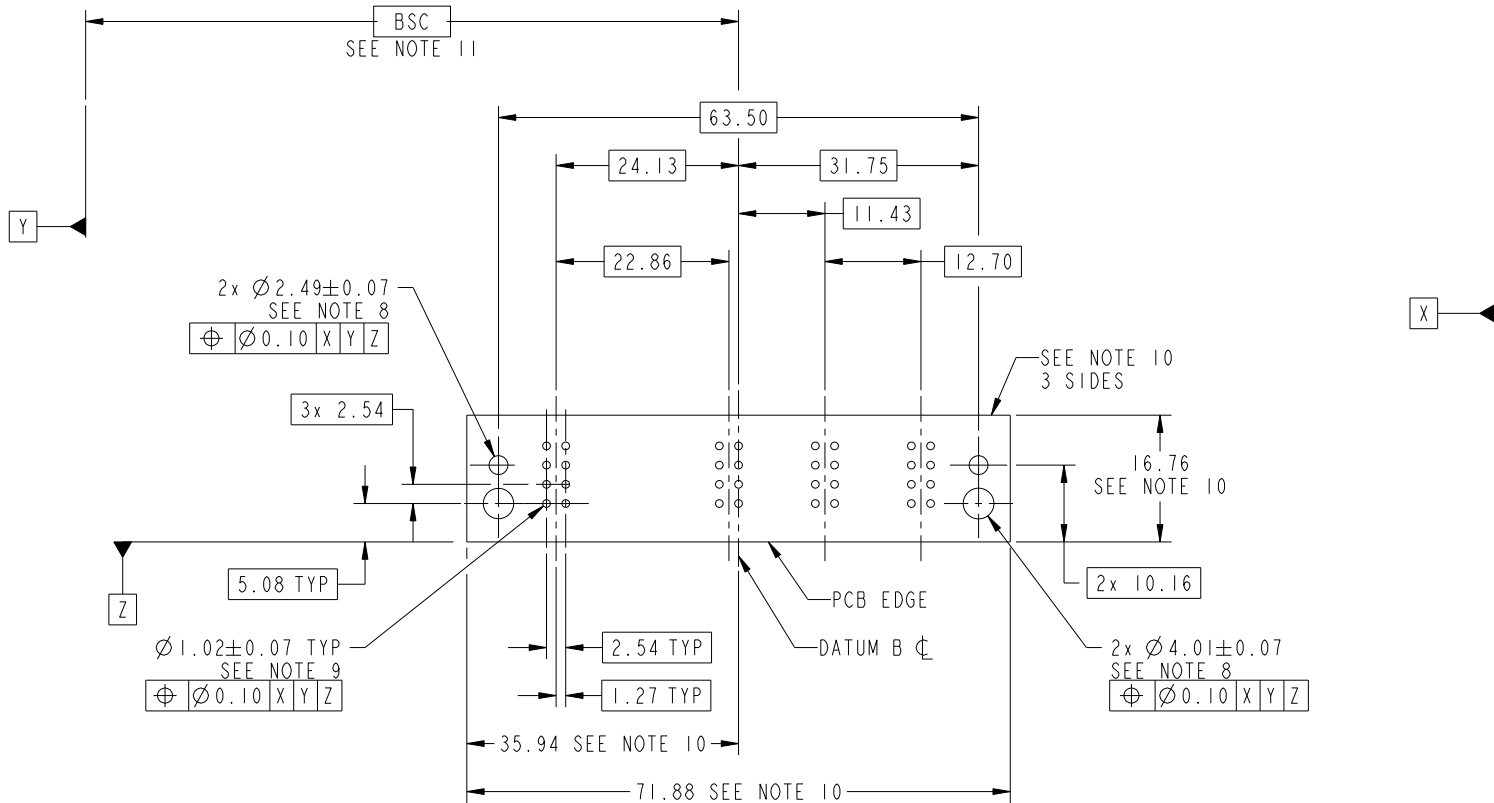

RECOMMENDED PCB LAYOUT

dr	De-Ming Lu	2014/12/12	projection 	MM 	size	A4	scale	1:1
eng	De-Ming Lu	2014/12/29			ecn no	-		
chr	-	-			rel level	Released		
appr	Pei-Ming Zheng	2014/12/29	product family	PwrBlade	rel level	Released		
	title	9P RIGHT ANGLE SOLDER HEADER		dwg no	51939-941		rev	A
www.fci.com	cat. no.	-	Product - Customer Drw		sheet 3 of 4			



Copyright FCI.

PRODUCT NUMBER
51939-941--
NOTE: 3

NOTES:

1. DIMENSIONS AND TOLERANCES ARE IN ACCORDANCE WITH ASME Y14.5M, 1994 UNLESS OTHERWISE SPECIFIED.

CONNECTOR NOTES:

- 2. HOUSING MATERIAL: UL 94 V-0 GLASS FILLED HIGH-TEMP THERMOPLASTIC
POWER CONTACT MATERIAL: COPPER ALLOY
SIGNAL PIN MATERIAL: COPPER ALLOY
- 3. SEE ITEM 1 & 2 IN PRINT 10064183 FOR PLATING SPEC OF 51939-941 AND 51939-941LF RESPECTIVELY.
- 4. MANUFACTURER'S NAME, DATE CODE AND OPTIONAL P/N TO APPEAR ON THIS SURFACE. THE MARK CAN BE OMITTED IF THERE IS NOT ENOUGH SPACE ON THIS SURFACE.
- 5. PRODUCT SPECIFICATION GS-12-149.
APPLICATION SPECIFICATION BUS-20-067.
- 6. PACKAGED IN TRAYS.

PCB NOTES:

- 7. ALL HOLE DIAMETERS ARE FINISHED HOLE SIZE.
- 8. MOUNTING HOLES, WHERE APPLICABLE, ARE UNPLATED.
- 9. $\varnothing 1.151 \pm 0.025$ DRILLED HOLES PLATED WITH
0.008 MIN SnPb OR Sn OVER 0.03
TO 0.08 Cu PLATING TO ACHIEVE
 $\varnothing 1.02 \pm 0.07$ HOLE.
- 10. CONNECTOR KEEP-OUT ZONE.
- 11. DATUM AND BASIC DIMENSIONS ARE ESTABLISHED BY CUSTOMER.



Copyright FCI.

dr	De-Ming Lu	2014/12/12	projection 	MM 	size	A4	scale	1:1		
eng	De-Ming Lu	2014/12/29			ecn no	-				
chr	-	-			product family	PwrBlade	rel level	Released		
appr	Pei-Ming Zheng	2014/12/29			title	9P RIGHT ANGLE SOLDER HEADER	dwg no	51939-941	rev	A
www.fci.com		cat. no.	-	Product - Customer Drw			sheet 4 of 4			