



## Typical Applications

Prescaler for DC to 4.0 GHz PLL Applications:

- DBS/CATV Tuners
- 802.11x & HiperLAN WLAN
- Fixed Wireless & WLL
- Microwave & VSAT Radios
- Cellular & 3G

## Features

- Ultra Low SSB Phase Noise: -146 dBc/Hz
- Wide Input Power Range: -15 to +10 dBm
- Output Power: +3.5 dBm
- Single DC Supply: +3V @ 13 mA
- MS8 SMT Package

## Functional Diagram

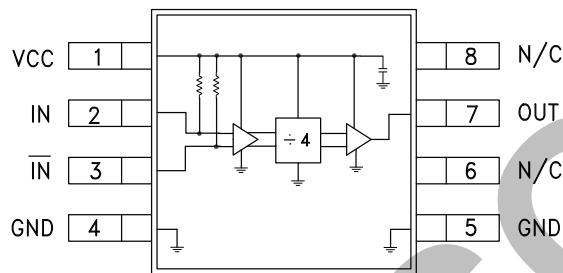

## General Description

The HMC426MS8 & HMC426MS8E are low noise Divide-by-4 Static Dividers utilizing SiGe technology in 8 lead surface mount plastic packages. This device operates from DC (with a square wave input) to 4.0 GHz input frequency while operating from a single +3V supply at only 13 mA. The low additive SSB phase noise of -146 dBc/Hz at 100 kHz offset helps the user maintain excellent system noise performance.

## Electrical Specifications, $T_A = +25^\circ\text{C}$ , 50 Ohm System, $V_{CC} = 3V$

Parameter	Conditions	Min.	Typ.	Max.	Units
Maximum Input Frequency		4.0	4.5		GHz
Minimum Input Frequency	Sine Wave Input. [1]		0.2	0.5	GHz
Input Power Range	$F_{in} = 0.5$ to 2 GHz	-15	-20	+5	dBm
	$F_{in} = 2$ to 4 GHz	-15	-20	+10	dBm
Output Power	$F_{in} = 1$ GHz	+0.5	+3.5		dBm
	$F_{in} = 4$ GHz	-3	0		dBm
Reverse Leakage			25		dB
SSB Phase Noise (100 kHz offset)	$P_{in} = 0$ dBm, $F_{in} = 3$ GHz		-146		dBc/Hz
Output Transition Time	$P_{in} = 0$ dBm, $F_{out} = 500$ MHz		400		ps
Supply Current ( $I_{CC}$ )			13		mA

1. Divider will operate down to DC for square-wave input signal.



**SMT SiGe MMIC  
DIVIDE-BY-4, DC - 4 GHz**

**Input Sensitivity Window,  $T = 25\text{ }^{\circ}\text{C}$**

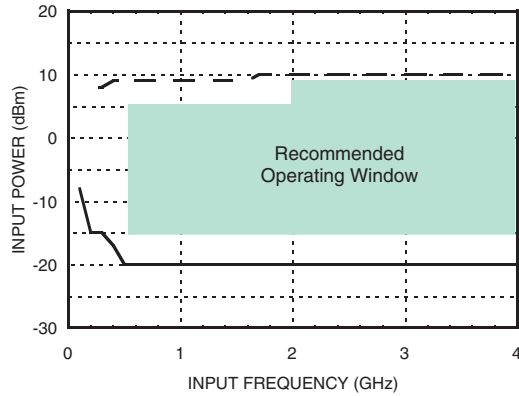

**Input Sensitivity Window vs. Temperature**

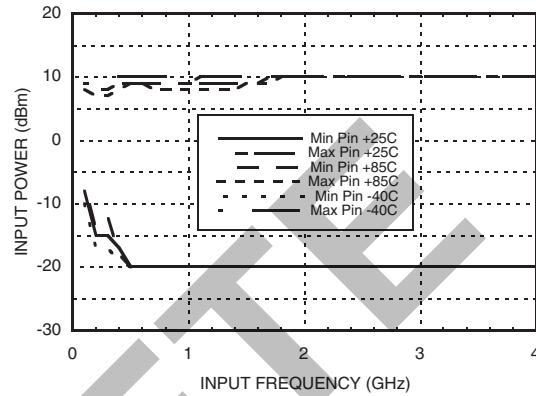

**Output Power vs. Temperature**

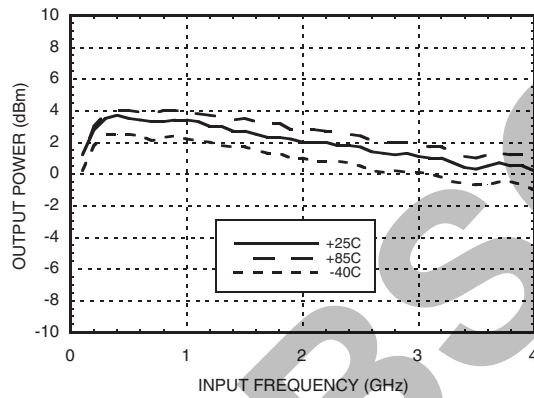

**SSB Phase Noise Performance @  $F_{in} = 3\text{ GHz}$   
 $P_{in} = 0\text{ dBm}$ ,  $T = 25\text{ }^{\circ}\text{C}$**

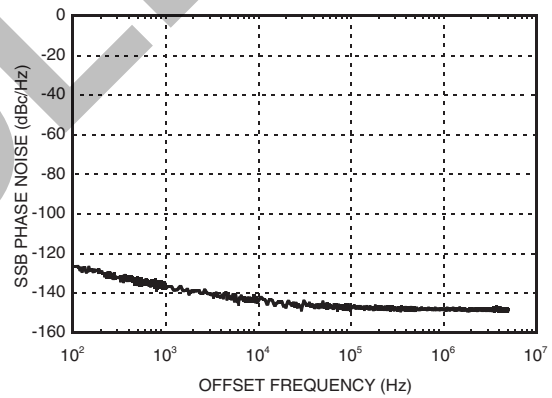

**Output Harmonic Content,  
 $P_{in} = 0\text{ dBm}$ ,  $T = 25\text{ }^{\circ}\text{C}$**

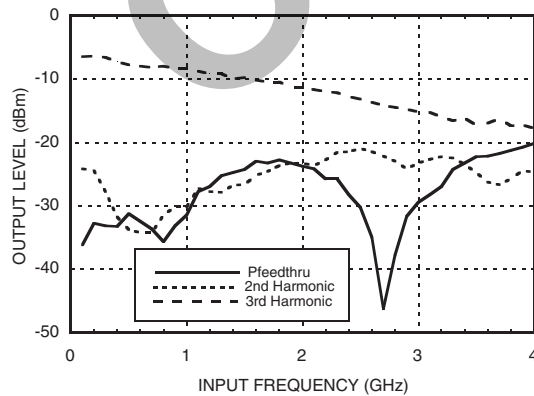

**Reverse Leakage,  $P_{in} = 0\text{ dBm}$ ,  $T = 25\text{ }^{\circ}\text{C}$**

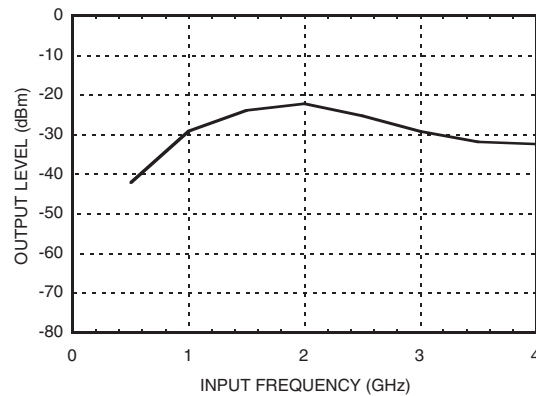

Information furnished by Analog Devices is believed to be accurate and reliable. However, no responsibility is assumed by Analog Devices for its use, nor for any infringements of patents or other rights of third parties that may result from its use. Specifications subject to change without notice. No license is granted by implication or otherwise under any patent or patent rights of Analog Devices. Trademarks and registered trademarks are the property of their respective owners.

For price, delivery, and to place orders: Analog Devices, Inc., One Technology Way, P.O. Box 9106, Norwood, MA 02062-9106 Phone: 781-329-4700 • Order online at [www.analog.com](http://www.analog.com) Application Support: Phone: 1-800-ANALOG-D



**Output Voltage Waveform,  
Pin= 0 dBm, Fout= 500 MHz, T= 25 °C**

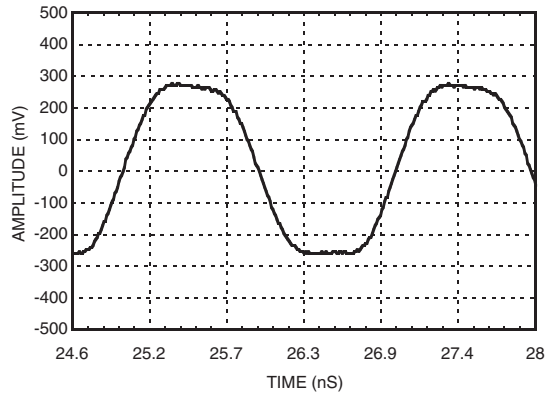

**Input Return Loss**

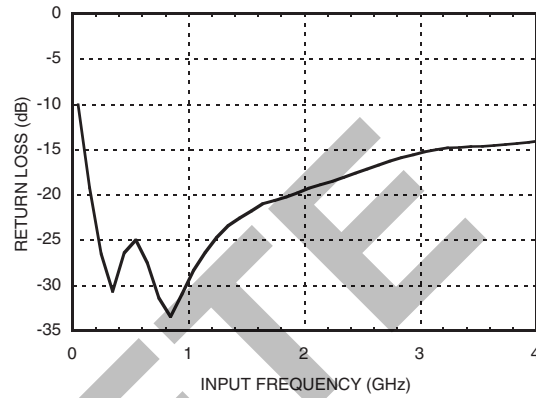

OBSOLETE



## Absolute Maximum Ratings

RF Input (Vcc = +3V)	+13 dBm
Vcc	+3.5V
Channel Temperature	150 °C
Continuous Pdiss (T = 85 °C) (derate 7 mW/ °C above 85 °C)	460 mW
Thermal Resistance (R <sub>TH</sub> )(junction to lead)	142 °C/W
Storage Temperature	-65 to +150 °C
Operating Temperature	-40 to +85 °C

## Typical Supply Current vs. Vcc

Vcc (V)	I <sub>cc</sub> (mA)
2.7	10
3.0	13
3.3	16

Note: Divider will operate over full voltage range shown above



**ELECTROSTATIC SENSITIVE DEVICE**  
**OBSERVE HANDLING PRECAUTIONS**

## Outline Drawing

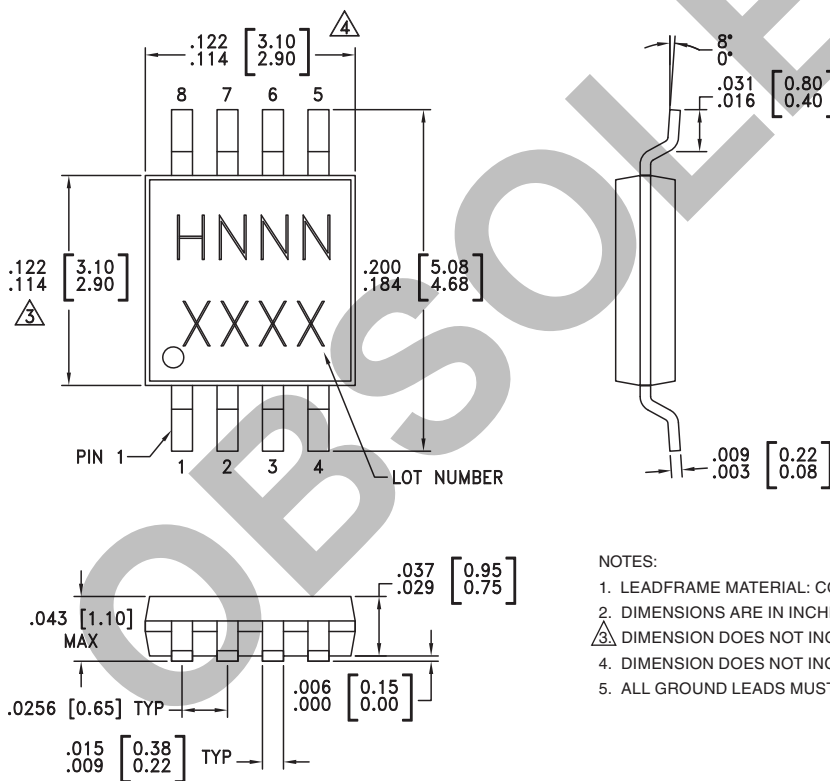

## Package Information

Part Number	Package Body Material	Lead Finish	MSL Rating	Package Marking <sup>[3]</sup>
HMC426MS8	Low Stress Injection Molding Plastic	Sn/Pb Solder	MSL1 <sup>[1]</sup>	H426 XXXX
HMC426MS8E	RoHS-compliant Low Stress Injection Molding Plastic	100% matte Sn	MSL1 <sup>[2]</sup>	H426 XXXX

[1] Max peak reflow temperature of 235 °C

[2] Max peak reflow temperature of 260 °C

[3] 4-Digit lot number XXXX

Information furnished by Analog Devices is believed to be accurate and reliable. However, no responsibility is assumed by Analog Devices for its use, nor for any infringements of patents or other rights of third parties that may result from its use. Specifications subject to change without notice. No license is granted by implication or otherwise under any patent or patent rights of Analog Devices. Trademarks and registered trademarks are the property of their respective owners.

For price, delivery, and to place orders: Analog Devices, Inc., One Technology Way, P.O. Box 9106, Norwood, MA 02062-9106  
Phone: 781-329-4700 • Order online at [www.analog.com](http://www.analog.com)  
Application Support: Phone: 1-800-ANALOG-D



**Pin Description**

Pin Number	Function	Description	Interface Schematic
1	VCC	Supply voltage 3V ± 0.3V.	
2	IN	RF Input must be DC blocked.	
3	IN	RF Input 180° out of phase with pin 2 for differential operation. AC ground for single ended operation.	
4, 5	GND	RF/DC Ground	
6, 8	N/C	No connection.	
7	OUT	Divided output.	

**Application Circuit**

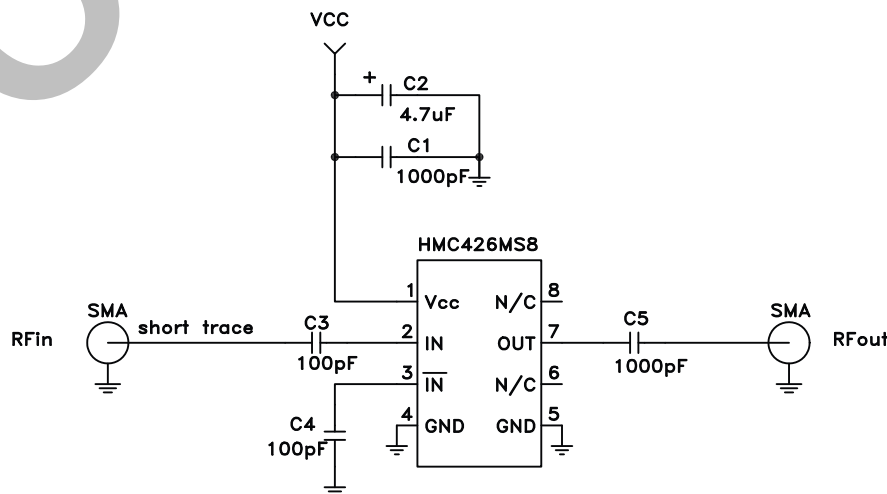

Information furnished by Analog Devices is believed to be accurate and reliable. However, no responsibility is assumed by Analog Devices for its use, nor for any infringements of patents or other rights of third parties that may result from its use. Specifications subject to change without notice. No license is granted by implication or otherwise under any patent or patent rights of Analog Devices. Trademarks and registered trademarks are the property of their respective owners.

For price, delivery, and to place orders: Analog Devices, Inc., One Technology Way, P.O. Box 9106, Norwood, MA 02062-9106 Phone: 781-329-4700 • Order online at [www.analog.com](http://www.analog.com) Application Support: Phone: 1-800-ANALOG-D



**Evaluation PCB**

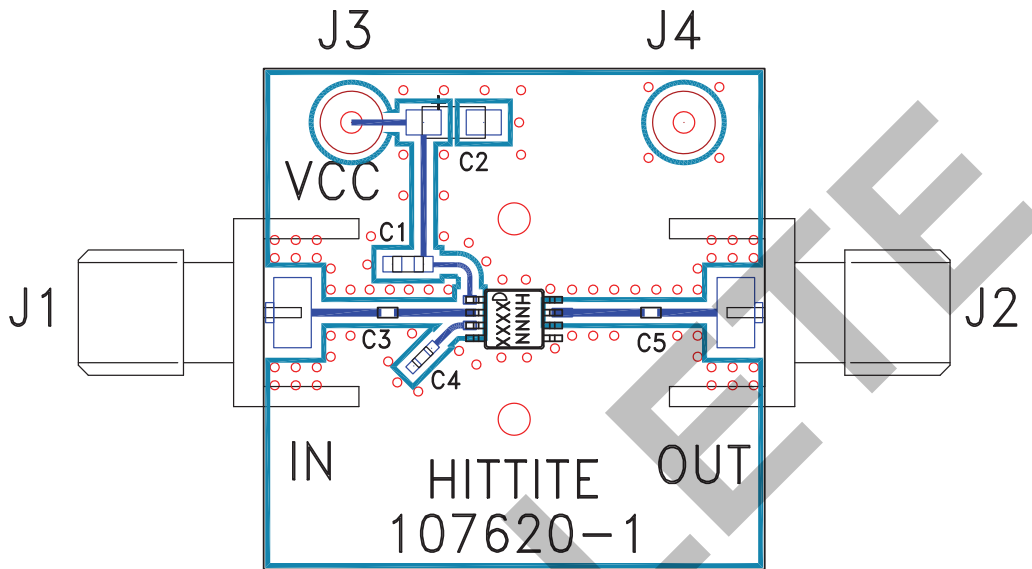

**List of Materials for Evaluation PCB 107622 [1]**

Item	Description
J1 - J2	PCB Mount SMA RF Connector
J3 - J4	DC Pin
C1	1000 pF Capacitor, 0603 Pkg.
C2	4.7 uF Tantalum Capacitor
C3 - C4	100 pF Capacitor, 0402 Pkg.
C5	1000 pF Capacitor, 0402 Pkg.
U1	HMC426MS8 / HMC426MS8E Divide-by-4
PCB [2]	107620 Eval Board

[1] Reference this number when ordering complete evaluation PCB

[2] Circuit Board Material: Rogers 4350

The circuit board used in the final application should use RF circuit design techniques. Signal lines should have 50 ohm impedance while the package ground leads should be connected directly to the ground plane similar to that shown. A sufficient number of via holes should be used to connect the top and bottom ground planes. The evaluation circuit board shown is available from Hittite upon request. This evaluation board is designed for single ended input and output testing.