

THIS DRAWING IS UNPUBLISHED.

RELEASED FOR PUBLICATION

2002

LOC

DIST

REVISIONS

© COPYRIGHT 2002

ALL RIGHTS RESERVED.

P	LTR	DESCRIPTION	DATE	DWN	APVD
U3		REVISED AND REDRAWN, ET00-0098-02	20 SEP 2002	HY	CT
U4		REVISED PER ECO-09-025699	19DEC09	KK	AEG
U5		ECR-10-022530	14JUN11	KK	HMR
U6		REVISED PER ECR-15-014177	11NOV2015	PK	TD

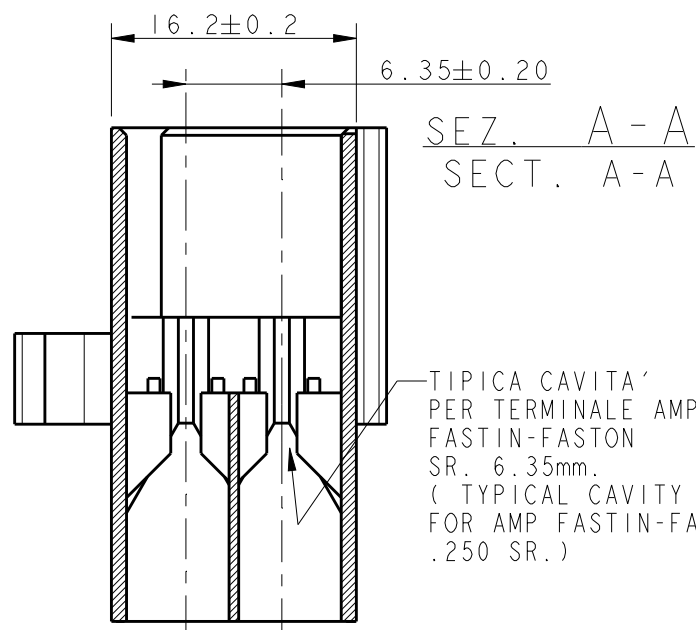

DIMENSIONI PER IL MONTAGGIO (MOUNTING DIMENSIONS)
PER IL BLOCCAGGIO PERPENDICOLARE AL PANNELLO DEI BLOCCHETTI
P/N 280430 O P/N 163008
(FOR FASTENING HSG P/N 280430 OR P/N 163008 PERPENDICULAR WITH PANEL.)

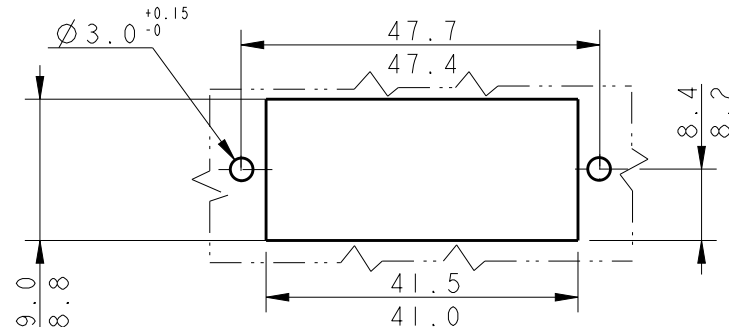

DIMENSIONI PER IL MONTAGGIO (MOUNTING DIMENSIONS)
PER IL BLOCCAGGIO PARALLELO AL PANNELLO DEI BLOCCHETTI
P/N 280430 O P/N 163008
(FOR FASTENING HSG P/N 280430 OR P/N 163008 IN PARALLEL WITH THE PANEL.)

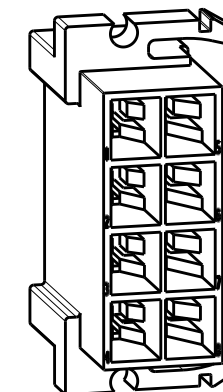
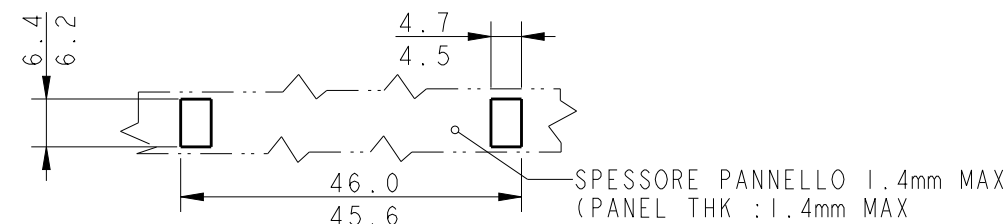

- 1 RISERVATO PER TE AMP DE FRANCE (RESTRICTED FOR TE AMP DE FRANCE)
- 2 RISERVATO "PHILCO™" (RESTRICTED FOR "PHILCO™")
- 3 VERSIONE NON DISPONIBILE IN TE AMP ITALIA (NOT AVAILABLE FROM TE AMP ITALY)
- 4 VERSIONE "GLOW WIRE" ("GLOW WIRE" VERSION)
- 5 MARCHIO DI FABBRICA AMP (AMP TRADE MARK)
- 6 NUMERO DI IMPRONTA STAMPO (MOULD CAVITY IDENTIFICATION NO)
- 7 OBSOLETE PARTS: OBSOLETE CIS STREAMLINING PER D.RENAUD/D.SINISI
- 8 280430-X IS REPLACED BY 163008-X

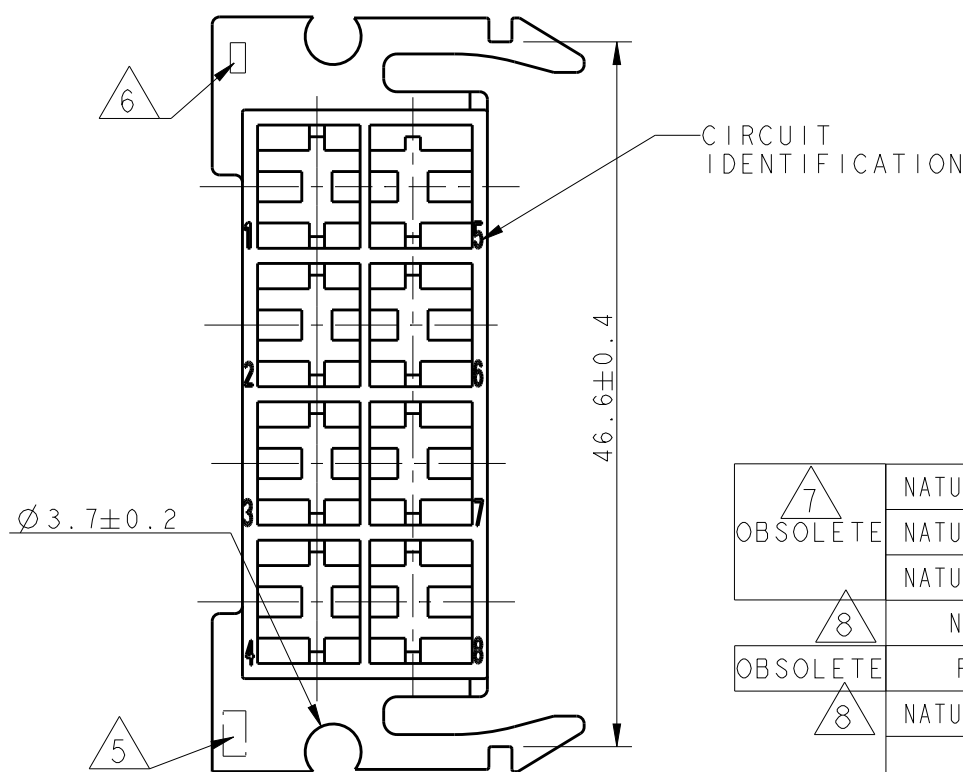
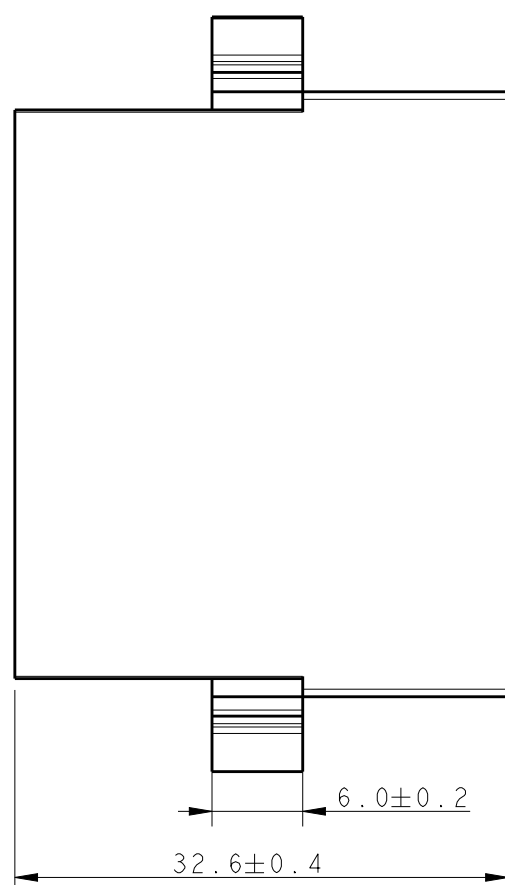
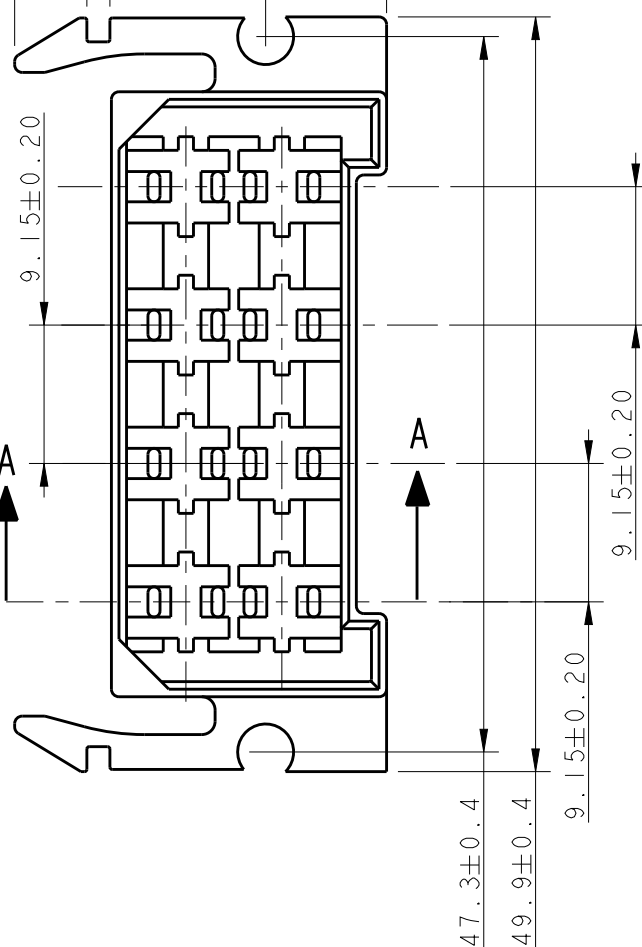
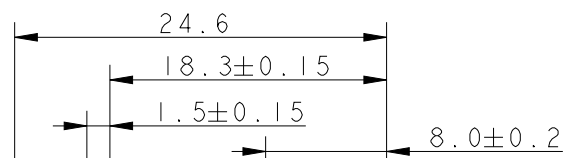

OBSOLETE	7	NATURALE (NATURAL)	ZYTEL 135F	4	4 280430 0	U
		NATURALE (NATURAL)	PA 6.6 (PA 6.6 UNFILLED)	3	3 280430 0	U
		NATURALE (NATURAL)		2	2 280430 0	U
OBSOLETE	8	NERO (BLACK)	PA 6.6 (PA 6.6 UNFILLED)		0 280430 5	U
		ROSSO (RED)			0 280430 1	U
		NATURALE (NATURAL)			0 280430 0	U
		COLORE (COLOUR)	MATERIALE (MATERIAL)		NUMERO (PART NUMBER)	REV

THIS DRAWING IS A CONTROLLED DOCUMENT.		DWN H. YAALI 10JUL2002
DIMENSIONS: mm		CHK C. TARTARI
TOLERANCES UNLESS OTHERWISE SPECIFIED:		APVD
0 PLC ±-	±0.3	PRODUCT SPEC 108-20020
1 PLC ±-		APPLICATION SPEC
2 PLC ±-		WEIGHT 8.16 g
3 PLC ±-		CUSTOMER DRAWING
4 PLC ±-		SCALE 2:1
ANGLES ±2°		SHEET 1 OF 1
MATERIAL SEE TABLE	FINISH SEE TABLE	REV U6

TE TE Connectivity

FASTIN-FASTON* Connector, .250inch srs. TAB HOUSING, 8 POSITIONS

SIZE A300779 CAGE CODE C-280430 DRAWING NO RESTRICTED TO