

1-207825-1 ✓ ACTIVE

AMP | AMP CPC

TE Internal #: 1-207825-1

Circular Power Connectors, Connector Assembly, 250 VDC, Wire-to-Board / Wire-to-Panel, 4 Position, Receptacle, Pin, Signal, Black, AMP CPC

[View on TE.com >](#)



Connectors > Power Connectors > Circular Power > Circular Power Connectors



Connector Product Type: **Connector Assembly**

Operating Voltage: **250 VDC**

Connector System: **Wire-to-Board, Wire-to-Panel**

Number of Positions: **4**

Sealable: **No**

Features

Product Type Features

Connector Product Type	Connector Assembly
Connector System	Wire-to-Board, Wire-to-Panel
Sealable	No
Connector & Housing Type	Receptacle
Circular Connector Shell Type	All Plastic

Configuration Features

Number of Positions	4
Number of Power Positions	0
Number of Signal Positions	4

Electrical Characteristics

Operating Voltage	250 VAC
-------------------	---------

Contact Features

Reverse Gender	No
Contact Type	Pin



Termination Features

Termination Method to Printed Circuit Board	Through Hole - Solder
---	-----------------------

Mechanical Attachment

Mating Alignment Type	Keyed
Mating Alignment	With
Panel Mount Feature Type	Flange with Threaded Inserts
Mating Retention Type	Threaded Coupling
Polarization Code	A
Connector Mounting Type	Panel Mount
Mating Retention	With
Panel Mount Feature	With

Housing Features

Housing Color	Black
Housing Material	PA 6.6
Circular Connector Shell Size	11

Dimensions

Assembly Length	49.47 mm[1.948 in]
-----------------	--------------------

Usage Conditions

Operating Temperature Range	-55 – 105 °C[-67 – 221 °F]
Fluid Resistance	None

Operation/Application

Circuit Application	Signal
Shielded	No

Industry Standards

UL Flammability Rating	UL 94V-0
------------------------	----------

Packaging Features

Packaging Quantity	24
Packaging Method	Tray

Product Compliance

[For compliance documentation, visit the product page on TE.com>](#)



EU RoHS Directive 2011/65/EU	Compliant with Exemptions
EU ELV Directive 2000/53/EC	Compliant with Exemptions
China RoHS 2 Directive MIIT Order No 32, 2016	Restricted Materials Above Threshold
EU REACH Regulation (EC) No. 1907/2006	<p>Current ECHA Candidate List: JUNE 2023 (235)</p> <p>Candidate List Declared Against: JUNE 2023 (235)</p> <p>SVHC > Threshold:</p> <p>Pb (3.7% in Component Part)</p> <p>Article Safe Usage Statements: Do not eat, drink or smoke when using this product. Wash thoroughly after handling. Recycle if possible and dispose of the article by following all applicable governmental regulations relevant to your geographic location.</p>
Halogen Content	BFR/CFR/PVC Free, but Br/Cl >900 ppm in other sources.
Solder Process Capability	Wave solder capable to 265°C

Product Compliance Disclaimer

This information is provided based on reasonable inquiry of our suppliers and represents our current actual knowledge based on the information they provided. This information is subject to change. The part numbers that TE has identified as EU RoHS compliant have a maximum concentration of 0.1% by weight in homogenous materials for lead, hexavalent chromium, mercury, PBB, PBDE, DBP, BBP, DEHP, DIBP, and 0.01% for cadmium, or qualify for an exemption to these limits as defined in the Annexes of Directive 2011/65/EU (RoHS2). Finished electrical and electronic equipment products will be CE marked as required by Directive 2011/65/EU. Components may not be CE marked. Additionally, the part numbers that TE has identified as EU ELV compliant have a maximum concentration of 0.1% by weight in homogenous materials for lead, hexavalent chromium, and mercury, and 0.01% for cadmium, or qualify for an exemption to these limits as defined in the Annexes of Directive 2000/53/EC (ELV). Regarding the REACH Regulation, the information TE provides on SVHC in articles for this part number is based on the latest European Chemicals Agency (ECHA) 'Guidance on requirements for substances in articles' posted at this URL: <https://echa.europa.eu/guidance-documents/guidance-on-reach>

Compatible Parts



Also in the Series | **AMP CPC**



Circular Connector Adapters(7)

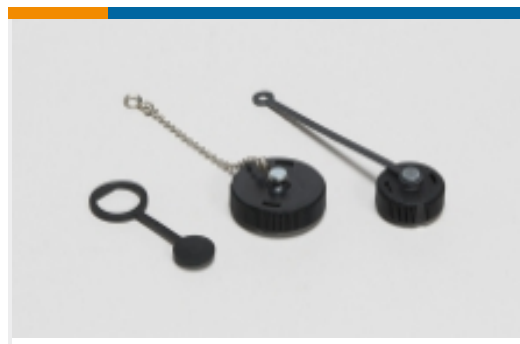

Circular Connector Caps & Covers(16)



Circular Connector Hardware(3)



Circular Connector Keying Plugs(2)



Circular Power Connectors(459)



Connector Backshells(56)



Connector Seals & Cavity Plugs(36)



Connector Strain Relief(6)



Insertion & Extraction Tools(1)

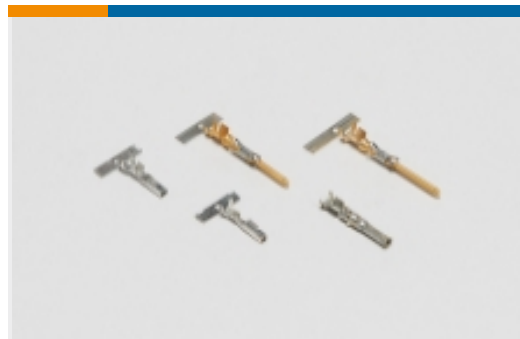

Power Contacts(6)

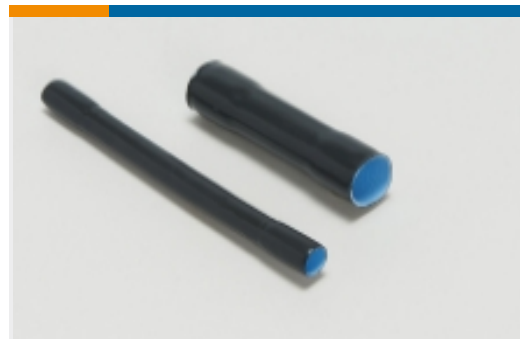

Sealing Sleeves(2)

Customers Also Bought



TE Part #1879378-3
TLR 2512 3.0W R0005 1% 50PPM 2K RL

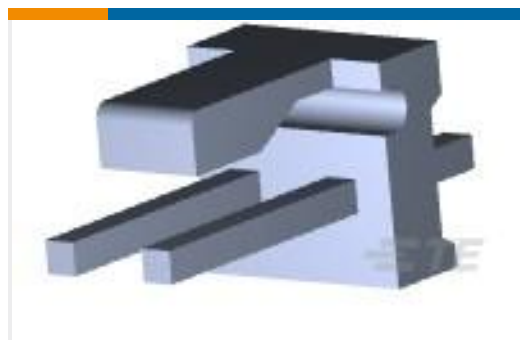

TE Part #640445-2
02P MTA156 HDR ASSY FL/STR SN



TE Part #1-208223-1
CPC RCPT ASSEMBLY SIZE 13-9

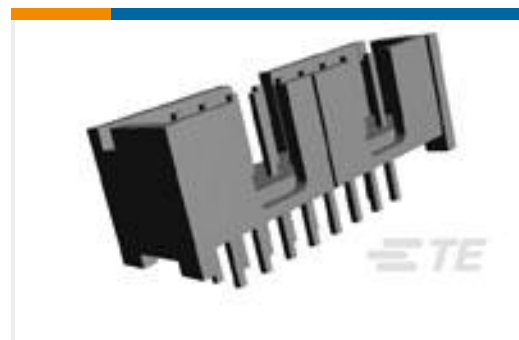

TE Part #103308-2
014 LOPRO HDR SP 15DP



TE Part #3-1437651-8
6DBL-03-006=#6 DBL TERMINAL BL



TE Part #8-1393766-6
R10-E1Z6-V430=R10

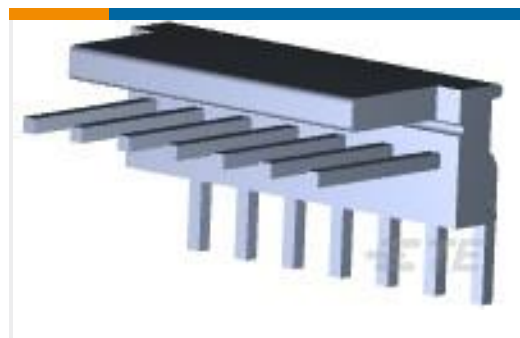

TE Part #3-641214-7
07P MTA100 HDR ASSY PO/RA LF



TE Part #EH9007-000
C5E-24C124-C14-0

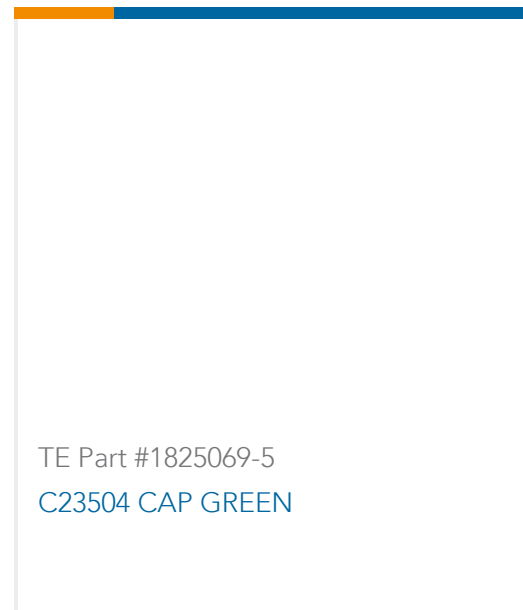

Documents

CAD Files

3D PDF

3D

Customer View Model

[ENG_CVM_CVM_1-207825-1_AG.2d_dxf.zip](#)

English

Customer View Model

[ENG_CVM_CVM_1-207825-1_AG.3d_igs.zip](#)

English

Customer View Model

[ENG_CVM_CVM_1-207825-1_AG.3d_stp.zip](#)

English

3D PDF

English

Customer View Model

[ENG_CVM_1-207825-1_R1.2d_dxf.zip](#)

English

Customer View Model

[ENG_CVM_1-207825-1_R1.3d_igs.zip](#)

English

Customer View Model

[ENG_CVM_1-207825-1_R1.3d_stp.zip](#)

English

By downloading the CAD file I accept and agree to the [Terms and Conditions](#) of use.

Product Specifications

Application Specification

English

Agency Approvals

CSA Certificate

English

CSA Certificate

English

