

Single-Output LDO Regulator

# Ultra Low Quiescent Current LDO Regulator



**BD7xxL5FP-C**

● **General Description**

The BD7xxL5FP-C are low quiescent regulators featuring 50V absolute maximum voltage, and output voltage accuracy of  $\pm 2\%$ , 500mA output current and 6 $\mu$ A (Typ.) current consumption. These regulators are therefore ideal for applications requiring a direct connection to the battery and a low current consumption. Ceramic capacitors can be used for compensation of the output capacitor phase. Furthermore, these ICs also feature overcurrent protection to protect the device from damage caused by short-circuiting and an integrated thermal shutdown to protect the device from overheating at overload conditions.

● **Key specifications**

- Ultra low quiescent current: 6 $\mu$ A (Typ.)
- Output voltage: 3.3V / 5.0V (Typ.)
- Output current capability: 500mA
- High output voltage accuracy:  $\pm 2\%$
- Low ESR ceramic capacitor can be used as output capacitor
- AEC-Q100 Qualified

● **Packages**

- FP: TO252-3 W (Typ.) x D (Typ.) x H (Max.)  
6.50mm x 9.50mm x 2.50mm

● **Features**

- Ultra low quiescent current: 6.0 $\mu$ A (Typ.)
- Output current capability: 500mA
- Output voltage: 3.3 V or 5.0 V(Typ.)
- High output voltage accuracy:  $\pm 2\%$
- Low saturation voltage by using PMOS output transistor.
- Integrated overcurrent protection to protect the IC from damage caused by output short-circuiting.
- Integrated thermal shutdown to protect the IC from overheating at overload conditions.
- Low ESR ceramic capacitor can be used as output capacitor.
- TO252-3 package



Figure 1. Package Outlook

● **Applications**

- Automotive (body, audio system, navigation system, etc.)

● **Typical Application Circuits**

- Components externally connected:  $0.1\mu\text{F} \leq \text{CIN}$ ,  $4.7\mu\text{F} \leq \text{COUT}$  (Typ.)  
\*Electrolytic, tantalum and ceramic capacitors can be used.

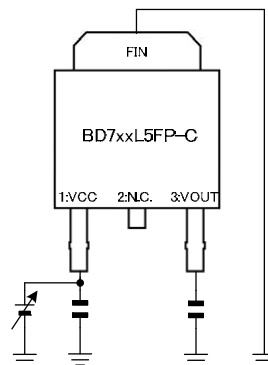

TO252-3

Figure 2. Typical Application Circuits

●Ordering Information

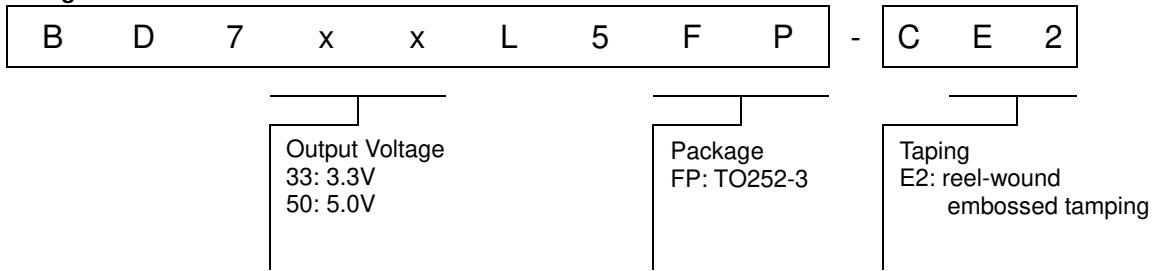

●Lineup

Output current ability	Output voltage (Typ.)	Package type	Orderable Part Number
500 mA	3.3 V	TO252-3	BD733L5FP-CE2
	5.0V		BD750L5FP-CE2

●Pin Configuration

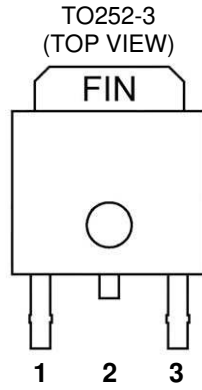

Figure 3. Pin Configuration

●Pin Description

Pin No.	Pin Name	Function
1	VCC	Supply voltage input pin
2	N.C.	N.C.
3	VOUT	Output pin
FIN	GND	GND

(\*N.C. terminals are not need to connect to GND.)

●Block Diagram

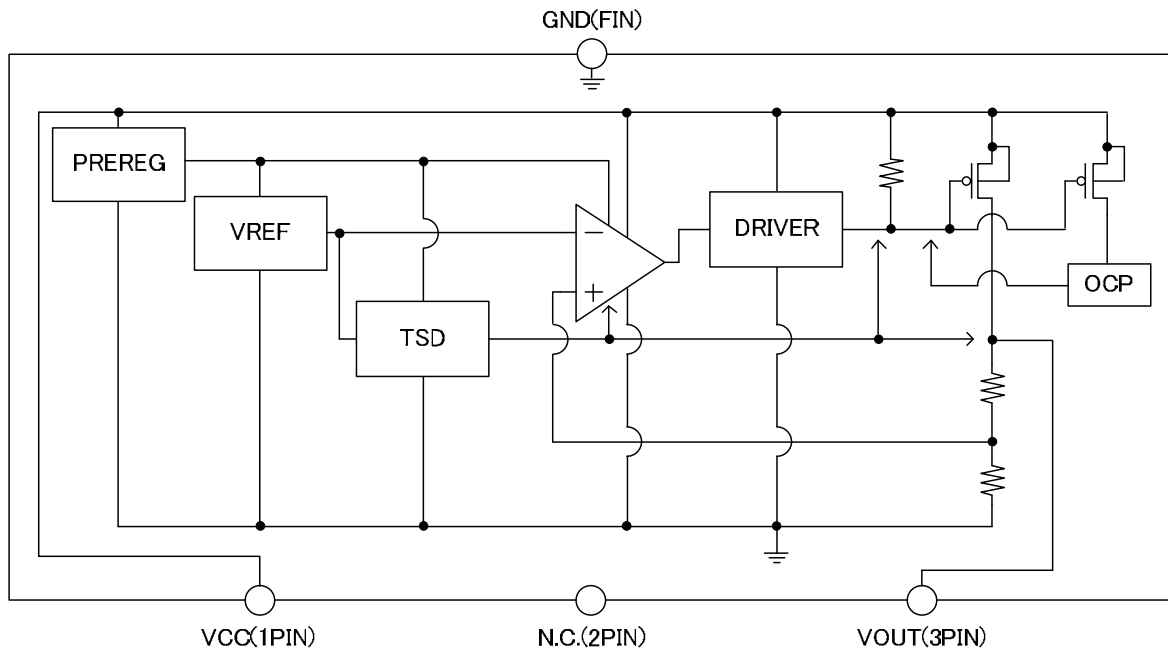

Figure 4. Block Diagram

### ● Absolute Maximum Ratings (Ta=25°C)

Parameter		Symbol	Ratings	Unit
Supply Voltage		*1 VCC	-0.3 to +50.0	V
Power Dissipation	TO252-3	*2 Pd	1.3	W
Operating Temperature Range		Topr	-40 to +125	°C
Storage Temperature Range		Tstg	-55 to +150	°C
Maximum Junction Temperature		Tjmax	150	°C

\*1 Pd should not be exceeded.

\*2 TO252-3 mounted on 114.3 mm x 76.2 mm x 1.6 mm Glass-Epoxy PCB based on JEDEC. If Ta ≥ 25 °C, reduce by 10.4 mW/°C.

(1-layer PCB: Copper foil area on the reverse side of PCB: 0 mm x 0 mm)

### ● Operating Conditions (-40 < Ta < +125°C)

#### ■ BD733L5FP-C

Parameter		Symbol	Min.	Max.	Unit
Supply Voltage		*3 VCC	4.17	45.0	V
Startup Voltage		*4 VCC	3.0	-	V
Output Current		IOUT	0	500	mA

#### ■ BD750L5FP-C

Parameter		Symbol	Min.	Max.	Unit
Supply Voltage		*3 VCC	5.6	45.0	V
Startup Voltage		*4 VCC	3.0	-	V
Output Current		IOUT	0	500	mA

\*3 For output voltage, refer to the dropout voltage corresponding to the output current. This condition is 200mA load.

\*4 When IOUT=0mA.

### ● Thermal Resistance

Parameter		Symbol	Min.	Max.	Unit
TO252-3 Package					
Junction to Ambient		*5 θja	24.5	-	°C/W
Junction to Case (bottom)		*5 θjc	3	-	°C/W

\*5 TO252-3 mounted on 114.3 mm x 76.2 mm x 1.6 mm Glass-Epoxy PCB based on JEDEC.

(4-layer PCB: Copper foil on the reverse side of PCB: 74.2 mm x 74.2 mm)

### ●Electrical Characteristics (BD733L5FP-C)

(Unless otherwise specified,  $-40 < T_a < +125^{\circ}\text{C}$ ,  $V_{CC}=13.5\text{V}$ ,  $I_{OUT}=0\text{mA}$ , Reference value:  $T_a=25^{\circ}\text{C}$ )

Parameter	Symbol	Limit			Unit	Conditions
		Min.	Typ.	Max.		
Bias current	I <sub>b</sub>	-	6	15	μA	
Output voltage	V <sub>OUT</sub>	3.23	3.30	3.37	V	8V < V <sub>CC</sub> < 16V 0mA < I <sub>OUT</sub> < 500mA
Dropout voltage	ΔV <sub>d</sub>	-	0.4	0.8	V	V <sub>CC</sub> =V <sub>OUT</sub> ×0.95, I <sub>OUT</sub> =200mA
Ripple rejection	R.R.	50	63	-	dB	f=120Hz, e <sub>in</sub> =1V <sub>rms</sub> , I <sub>OUT</sub> =100mA
Line regulation	Reg I	-	5	20	mV	8V < V <sub>CC</sub> < 16V
Load regulation	Reg L	-	5	20	mV	10mA < I <sub>OUT</sub> < 250mA

### ●Electrical Characteristics (BD750L5FP-C)

(Unless otherwise specified,  $-40 < T_a < +125^{\circ}\text{C}$ ,  $V_{CC}=13.5\text{V}$ ,  $I_{OUT}=0\text{mA}$ , Reference value:  $T_a=25^{\circ}\text{C}$ )

Parameter	Symbol	Limit			Unit	Conditions
		Min.	Typ.	Max.		
Bias current	I <sub>b</sub>	-	6	15	μA	
Output voltage	V <sub>OUT</sub>	4.9	5.0	5.1	V	8V < V <sub>CC</sub> < 16V 0mA < I <sub>OUT</sub> < 500mA
Dropout voltage	ΔV <sub>d</sub>	-	0.25	0.5	V	V <sub>CC</sub> =V <sub>OUT</sub> ×0.95, I <sub>OUT</sub> =200mA
Ripple rejection	R.R.	50	60	-	dB	f=120Hz, e <sub>in</sub> =1V <sub>rms</sub> , I <sub>OUT</sub> =100mA
Line regulation	Reg I	-	5	20	mV	8V < V <sub>CC</sub> < 16V
Load regulation	Reg L	-	5	20	mV	10mA < I <sub>OUT</sub> < 250mA

● Typical Performance Curves

■ BD733L5FP-C Reference data

Unless otherwise specified:  $-40 < T_a < +125^{\circ}\text{C}$ ,  $V_{CC}=13.5\text{V}$ ,  $I_{OUT}=0\text{mA}$

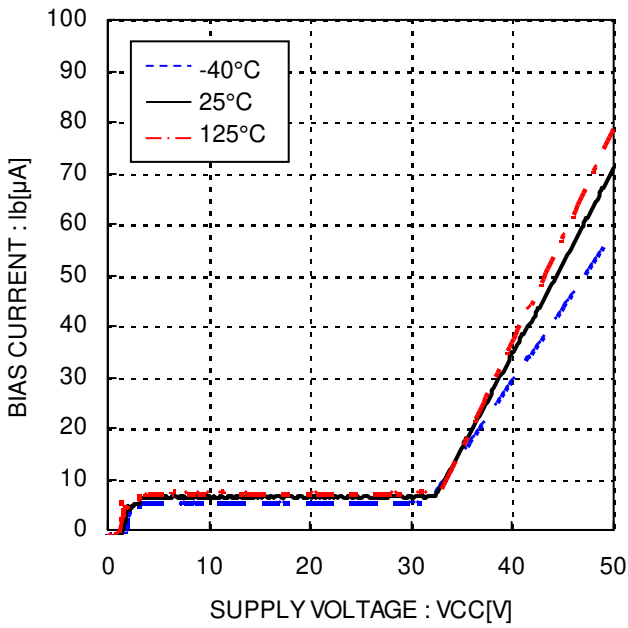

Figure 5. Bias current

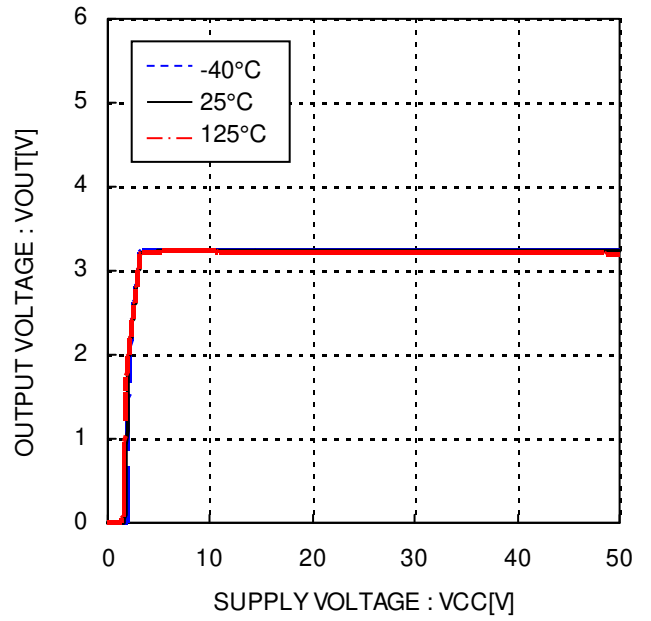

Figure 6. Output voltage vs. Supply voltage  
 $I_{OUT}=10\text{mA}$

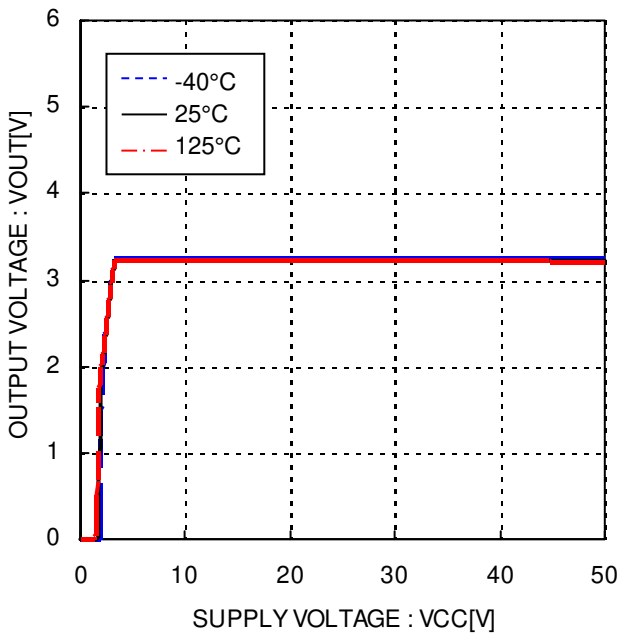

Figure 7. Output voltage vs. Supply voltage  
 $I_{OUT}=100\text{mA}$

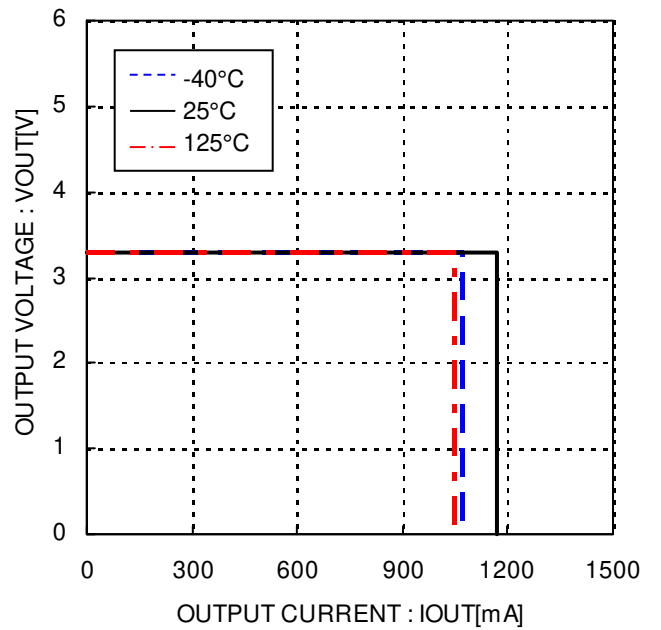

Figure 8. Output voltage vs. Load

■ BD733L5FP-C Reference data

Unless otherwise specified:  $-40 < T_a < +125^{\circ}\text{C}$ ,  $V_{CC}=13.5\text{V}$ ,  $I_{OUT}=0\text{mA}$

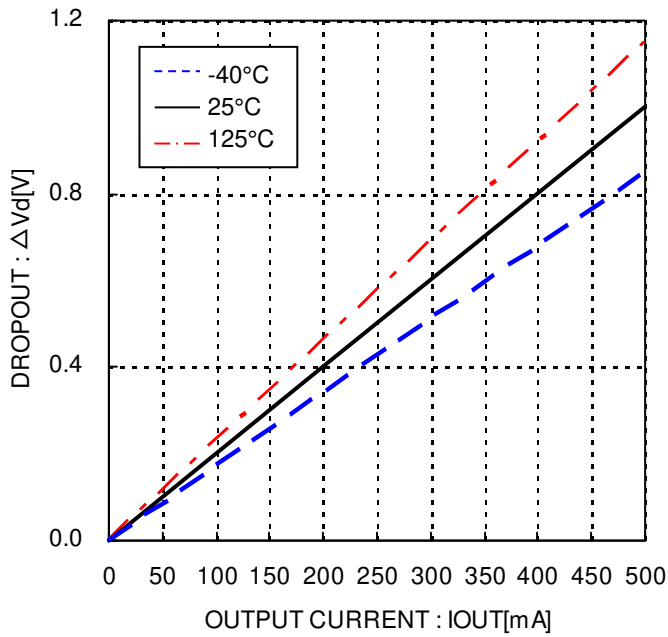

Figure 9. Dropout voltage

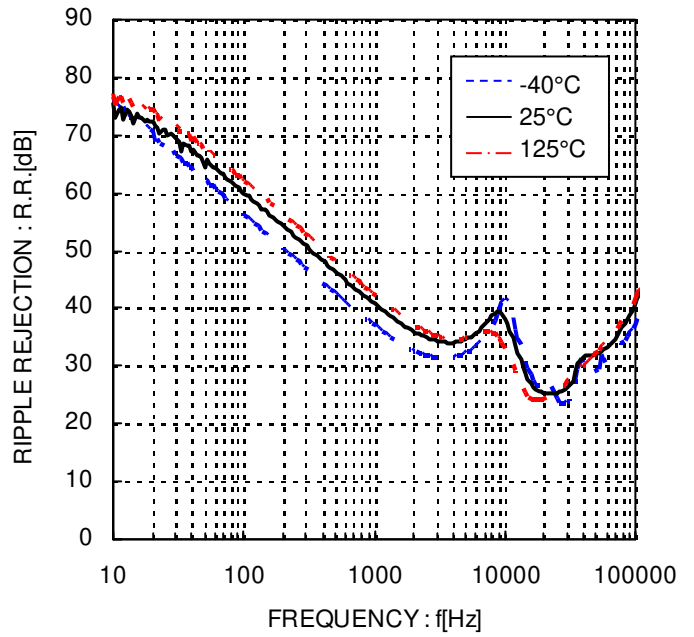

Figure 10. Ripple rejection  
( $e_{in}=1\text{V}_{rms}$ ,  $I_{OUT}=100\text{mA}$ )

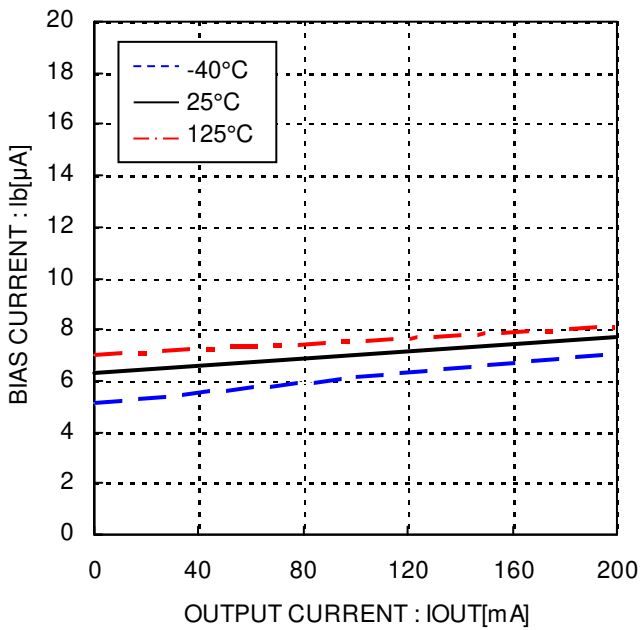

Figure 11. Total supply current vs. Load

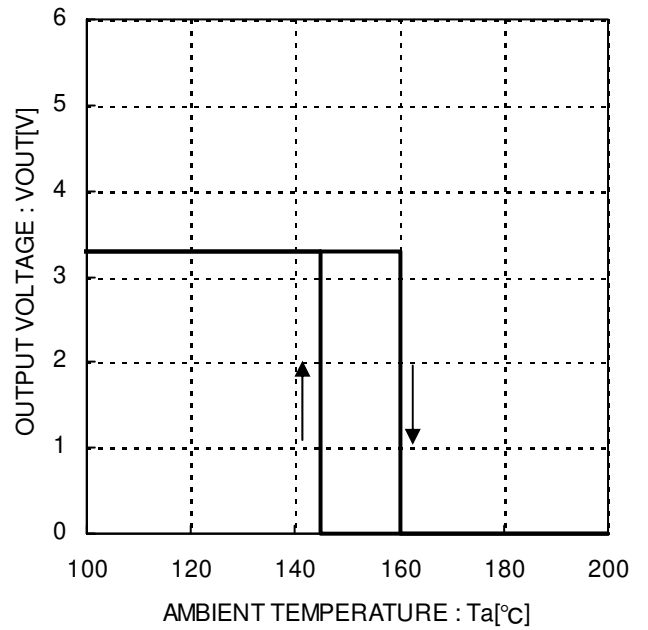

Figure 12. Thermal shutdown  
(Output voltage vs. Temperature)

■BD733L5FP-C Reference data

Unless otherwise specified:  $-40 < T_a < +125^{\circ}\text{C}$ ,  $V_{CC}=13.5\text{V}$ ,  $I_{OUT}=0\text{mA}$

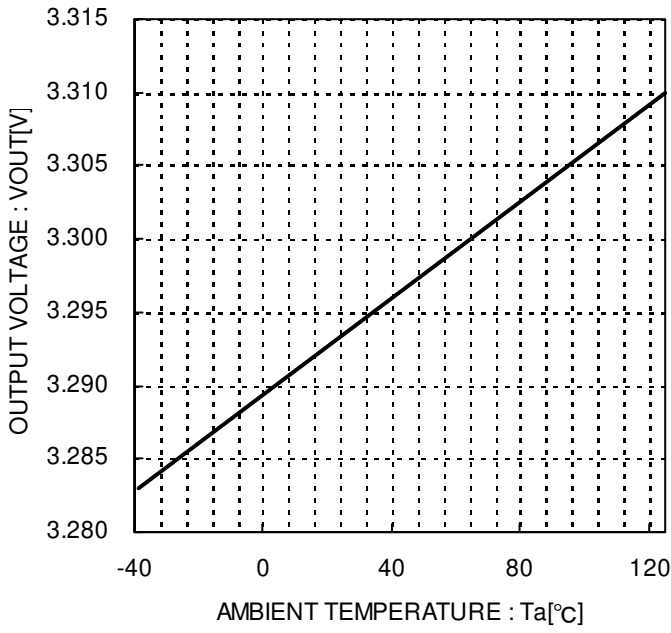

Figure 13. Output voltage vs. Temperature

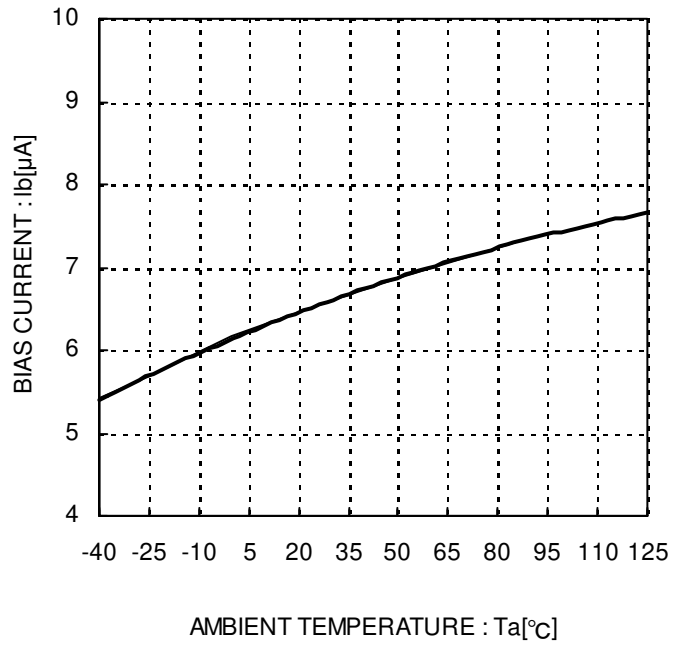

Figure 14. Bias current vs. Temperature



■BD750L5FP-C Reference data

Unless otherwise specified:  $-40 < T_a < +125^{\circ}\text{C}$ ,  $V_{CC}=13.5\text{V}$ ,  $I_{OUT}=0\text{mA}$

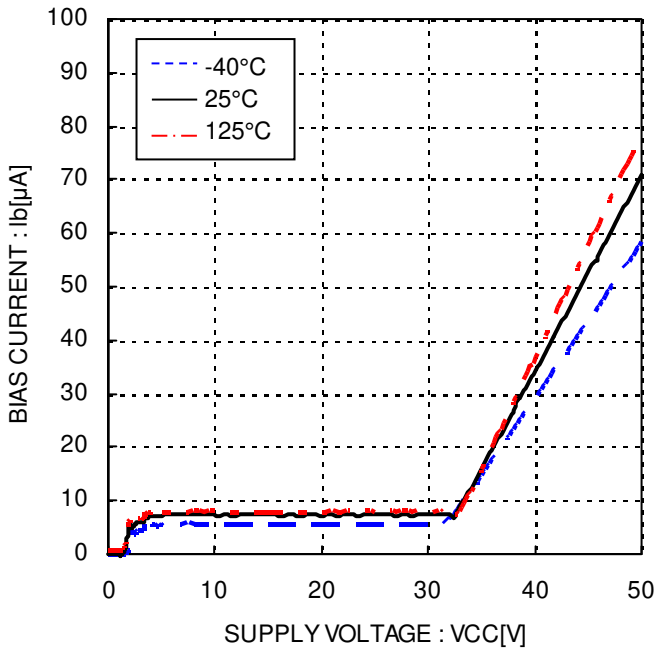

Figure 15. Bias current

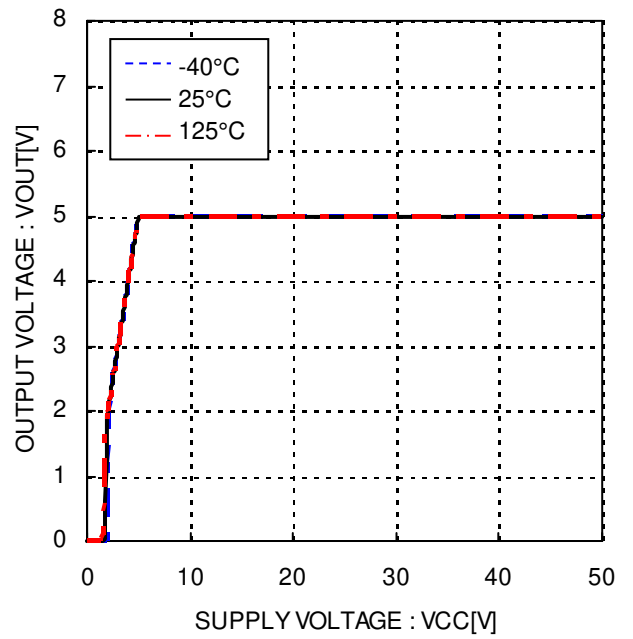

Figure 16. Output voltage vs. Supply voltage

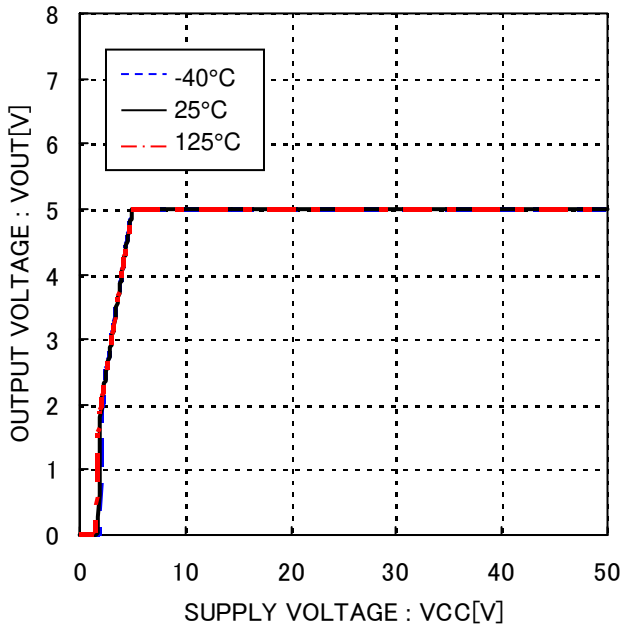

Figure 17. Output voltage vs. Supply voltage  
 $I_{OUT}=100\text{mA}$

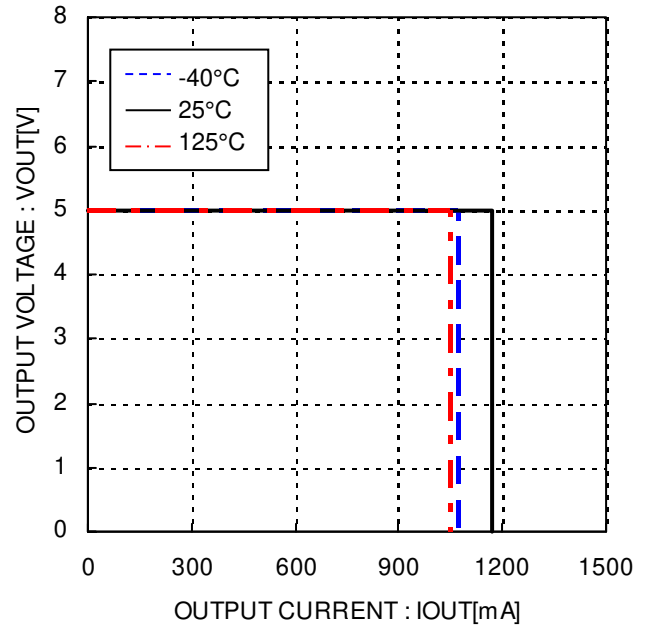

Figure 18. Output voltage vs. Load

■BD750L5FP-C Reference data

Unless otherwise specified:  $-40 < T_a < +125^{\circ}\text{C}$ ,  $V_{CC}=13.5\text{V}$ ,  $I_{OUT}=0\text{mA}$

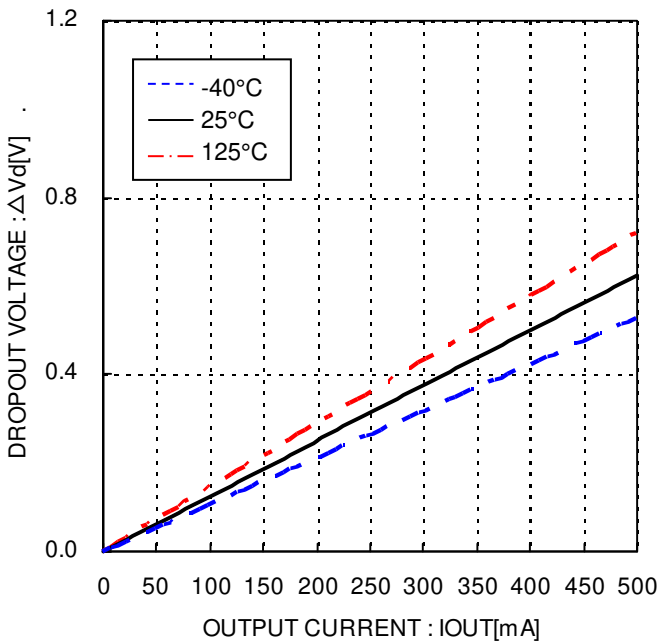

Figure 19. Dropout voltage

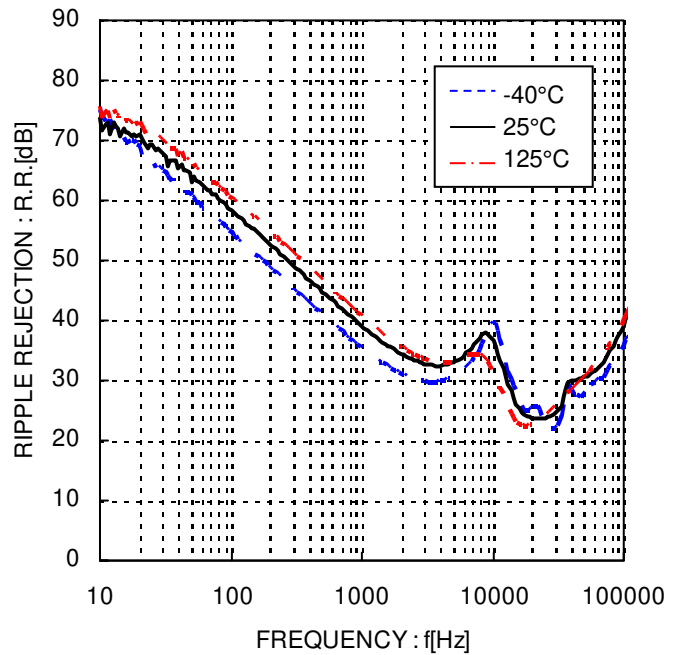

Figure 20. Ripple rejection  
( $e_{in}=1\text{V}_{rms}$ ,  $I_{OUT}=100\text{mA}$ )

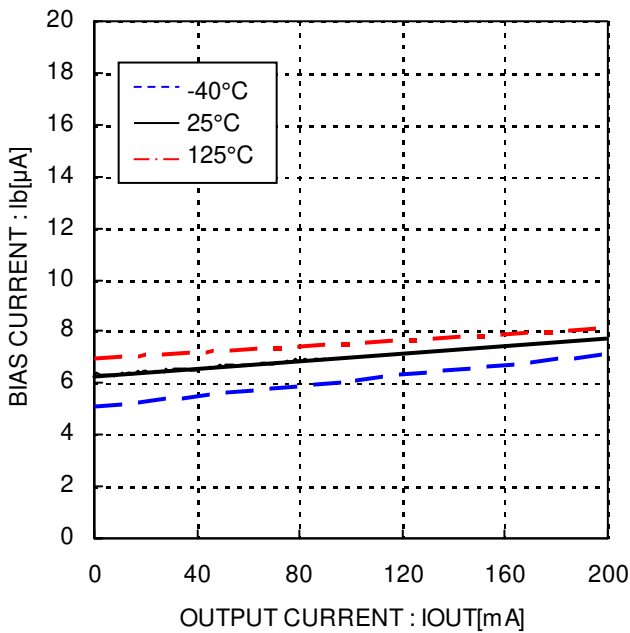

Figure 21. Total supply current vs. Load

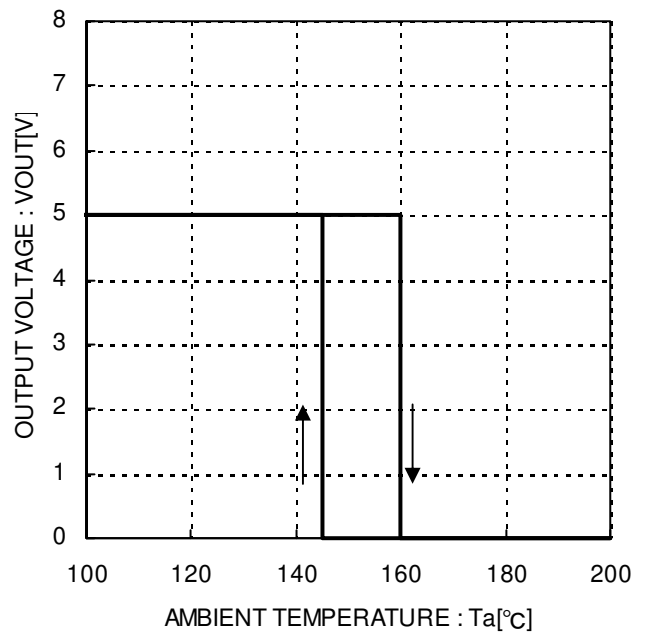

Figure 22. Thermal shutdown  
(Output voltage vs. Temperature)

■BD750L5FP-C Reference data

Unless otherwise specified:  $-40 < T_a < +125^{\circ}\text{C}$ ,  $V_{CC}=13.5\text{V}$ ,  $I_{OUT}=0\text{mA}$

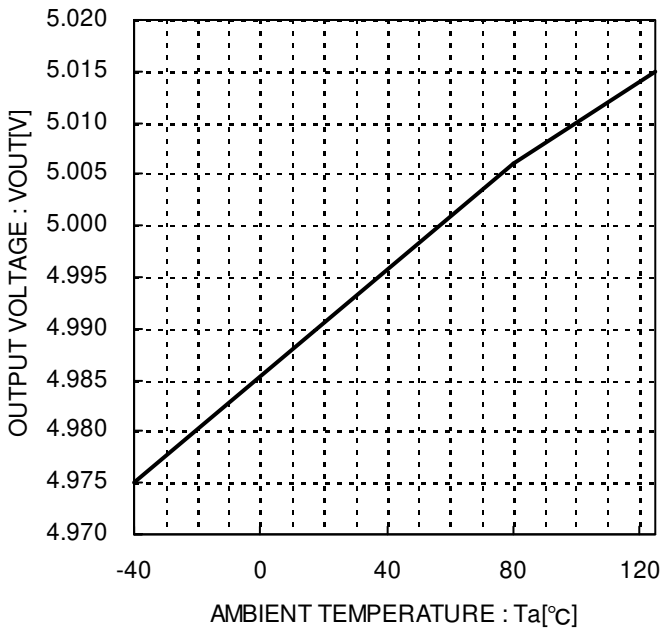

Figure 23. Output voltage vs. Temperature

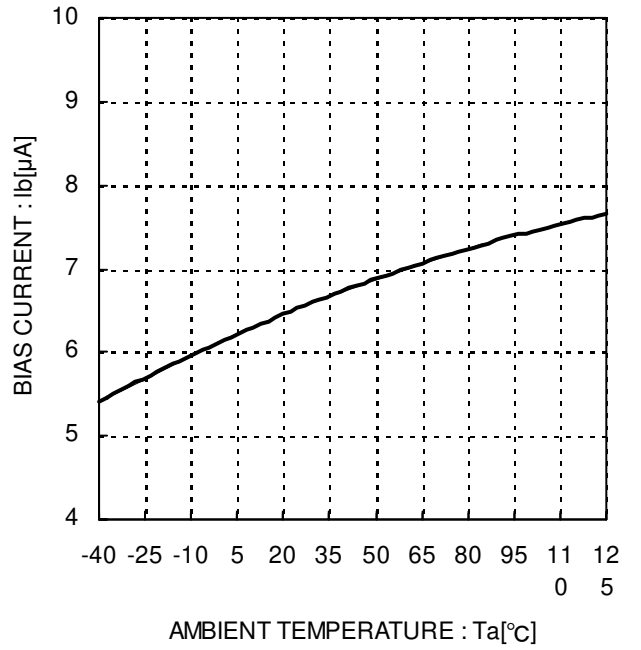
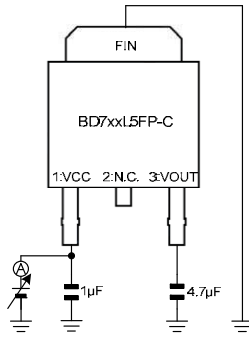
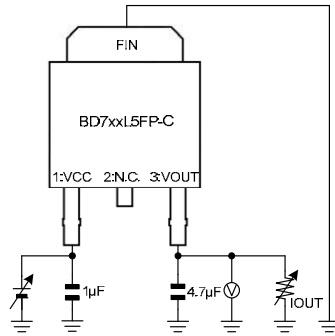

Figure 24. Bias current vs. Temperature

●Reference data (BD7xxL5FP-C Series) TO252-3



Measurement setup for Figure 5, 14, 15, 24



Measurement setup for Figure 6, 7, 12, 13, 16, 17, 22, 23

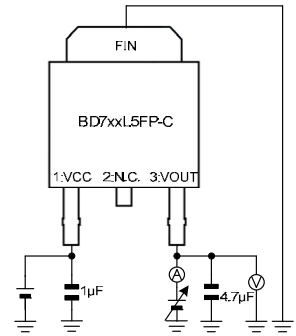

Measurement setup for Figure 8, 18

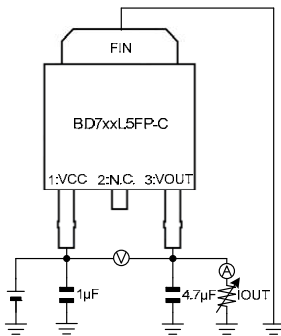

Measurement setup for Figure 9, 19

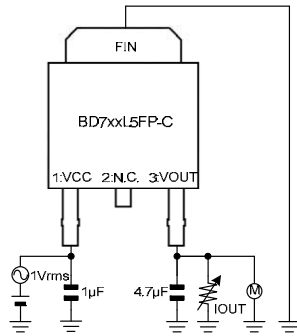

Measurement setup for Figure 10, 20

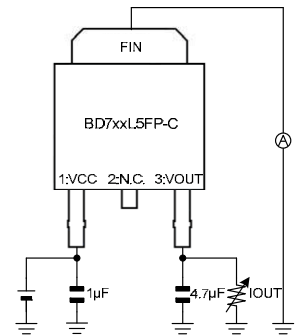

Measurement setup for Figure 11, 21

● Selection of Components Externally Connected

• VCC pin

Insert capacitors with a capacitance of 0.1μF or higher between the VCC and GND pin. Choose the capacitance according to the line between the power smoothing circuit and the VCC pin. Selection of the capacitance also depends on the application. Verify the application and allow for sufficient margins in the design. We recommend using a capacitor with excellent voltage and temperature characteristics.

• Output pin capacitor

In order to prevent oscillation, a capacitor needs to be placed between the output pin and GND pin. We recommend using a capacitor with a capacitance of 4.7μF or higher. Electrolytic, tantalum and ceramic capacitors can be used. When selecting the capacitor ensure that the capacitance of 4.7μF or higher is maintained at the intended applied voltage and temperature range. Due to changes in temperature the capacitor's capacitance can fluctuate possibly resulting in oscillation. For selection of the capacitor refer to the IO<sub>UT</sub> vs. ESR data. The stable operation range given in the reference data is based on the standalone IC and resistive load. For actual applications the stable operating range is influenced by the PCB impedance, input supply impedance and load impedance. Therefore verification of the final operating environment is needed.

When selecting a ceramic type capacitor, we recommend using X5R, X7R or better with excellent temperature and DC-biasing characteristics and high voltage tolerance.

Also, in case of rapidly changing input voltage and load current, select the capacitance in accordance with verifying that the actual application meets with the required specification.

● Measurement setup

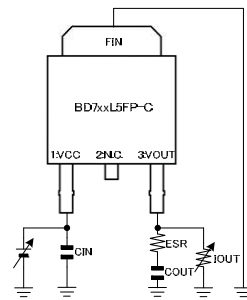

TO252-3

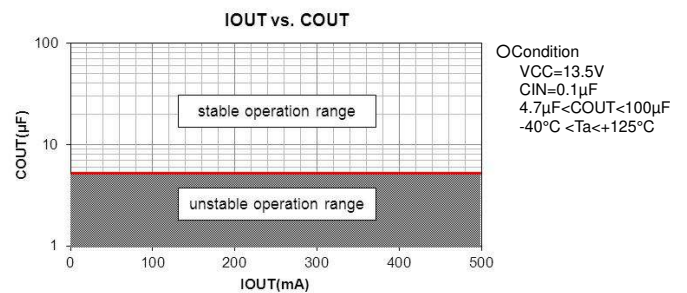
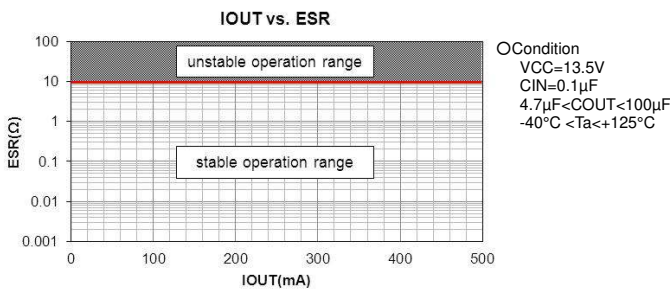

● Power Dissipation

■ TO252-3

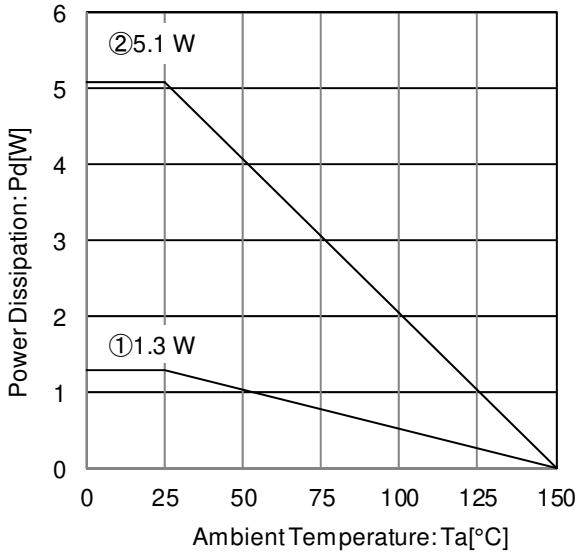

Figure 25. Package Data (TO252-3)

IC mounted on ROHM standard board based on JEDEC.

Board material: FR4

Board size: 114.3 mm x 76.2 mm x 1.6 mm (with thermal via on the board)

Mount condition: PCB and exposed pad are soldered.

Top copper foil: The footprint ROHM recommend.

+ wiring to measure.

①: 1-layer PCB

(Copper foil area on the reverse side of PCB: 0 mm x 0 mm)

②: 4-layer PCB

(2 inner layers and copper foil area on the reverse side of PCB: 74.2mm x 74.2 mm)

Condition①:  $\theta_{ja} = 96.2 \text{ }^\circ\text{C/W}$ ,  $\theta_{jc(\text{top})} = 22 \text{ }^\circ\text{C/W}$

Condition②:  $\theta_{ja} = 24.5 \text{ }^\circ\text{C/W}$ ,  $\theta_{jc(\text{top})} = 5 \text{ }^\circ\text{C/W}$ ,  
 $\theta_{jc(\text{bottom})} = 3 \text{ }^\circ\text{C/W}$

Refer to the heat mitigation characteristics illustrated in Figure 25 when using the IC in an environment of  $T_a \geq 25^\circ\text{C}$ . The characteristics of the IC are greatly influenced by the operating temperature, and it is necessary to operate under the maximum junction temperature  $T_{\text{max}}$ .

Figure 25 show the power dissipation and heat mitigation characteristics of the TO252-3 package. Even if the ambient temperature  $T_a$  is at  $25^\circ\text{C}$  it is possible that the junction temperature  $T_j$  reaches high temperatures. Therefore, the IC should be operated within the power dissipation range.

The following method is used to calculate the power consumption  $P_c$  (W)

$$P_c = (V_{CC} - V_{OUT}) \times I_{OUT} + V_{CC} \times I_b$$

Power dissipation  $P_d \geq P_c$

$V_{CC}$  : Input voltage  
 $V_{OUT}$  : Output voltage  
 $I_{OUT}$  : Load current  
 $I_b$  : Bias current  
 $I_{\text{short}}$  : Shorted current

The load current  $I_o$  is obtained by operating the IC within the power dissipation range.

$$I_{OUT} \leq \frac{P_d - V_{CC} \times I_b}{V_{CC} - V_{OUT}}$$

(Refer to Figure11 and Figure21 for the  $I_b$ )

Thus, the maximum load current  $I_{OUT\text{max}}$  for the applied voltage  $V_{CC}$  can be calculated during the thermal design process.

#### ● TO252-3

■ Calculation example 1) with  $T_a = 125^\circ\text{C}$ ,  $V_{CC} = 13.5\text{V}$ ,  $V_{OUT} = 3.3\text{V}$

$$I_{OUT} \leq \frac{1.02 - 13.5 \times I_b}{10.2}$$

$$I_{OUT} \leq 100\text{mA} \quad (I_b: 6\mu\text{A})$$

$$\left( \begin{array}{l} \theta_{ja} = 24.5^\circ\text{C/W} \rightarrow -40.8\text{mW}/^\circ\text{C} \\ 25^\circ\text{C} = 5.10\text{W} \rightarrow 125^\circ\text{C} = 1.02\text{W} \end{array} \right)$$

At  $T_a = 125^\circ\text{C}$  with Figure 25 ② condition, the calculation shows that ca 100mA of output current is possible at 10.2V potential difference across input and output.

■ Calculation example 2) with  $T_a = 125^\circ\text{C}$ ,  $V_{CC} = 13.5\text{V}$ ,  $V_{OUT} = 5.0\text{V}$  (TO252-3)

$$I_{OUT} \leq \frac{1.02 - 13.5 \times I_b}{8.5}$$

$$I_{OUT} \leq 120\text{mA} \quad (I_b: 6\mu\text{A})$$

$$\left( \begin{array}{l} \theta_{ja} = 24.5^\circ\text{C/W} \rightarrow -40.8\text{mW}/^\circ\text{C} \\ 25^\circ\text{C} = 5.10\text{W} \rightarrow 125^\circ\text{C} = 1.02\text{W} \end{array} \right)$$

At  $T_a = 125^\circ\text{C}$  with Figure 25 ② condition, the calculation shows that ca 120mA of output current is possible at 8.5V potential difference across input and output.

The thermal calculation shown above should be taken into consideration during the thermal design in order to keep the whole operating temperature range within the power dissipation range.

In the event of shorting (i.e.  $V_{OUT}$  and GND pins are shorted) the power consumption  $P_c$  of the IC can be calculated as follows:

$$P_c = V_{CC} \times (I_b + I_{\text{short}}) \quad (\text{Refer to Figure 8 and Figure 18 for the } I_{\text{short}})$$

● Application Examples

- Applying positive surge to the VCC pin

If the possibility exists that surges higher than 50V will be applied to the VCC pin, a zenar diode should be placed between the VCC pin and GND pin as shown in the figure below.

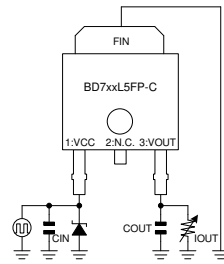

TO252-3

- Applying negative surge to the VCC pin

If the possibility exists that negative surges lower than the GND are applied to the VCC pin, a Shottky diode should be placed between the VCC pin and GND pin as shown in the figure below.

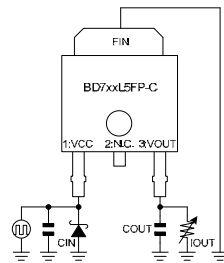

TO252-3

- Implementing a protection diode

If the possibility exists that a large inductive load is connected to the output pin resulting in back-EMF at time of startup and shutdown, a protection diode should be placed as shown in the figure below.

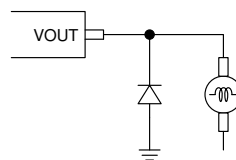

● I/O equivalence circuits

○ Input terminal

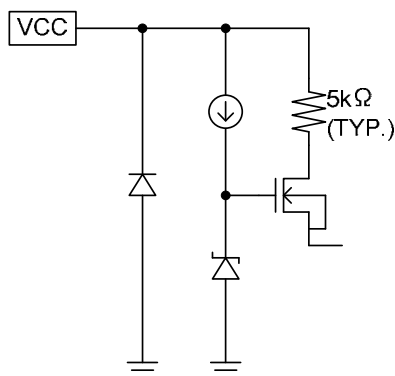

○ Output terminal \*inside of ( ) shows 5V

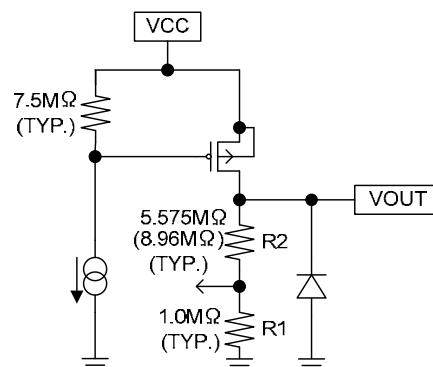



## ●Operational Notes

- 1) Absolute maximum ratings  
Exceeding the absolute maximum rating for supply voltage, operating temperature or other parameters can result in damages to or destruction of the chip. In this event it also becomes impossible to determine the cause of the damage (e.g. short circuit, open circuit, etc.). Therefore, if any special mode is being considered with values expected to exceed the absolute maximum ratings, implementing physical safety measures, such as adding fuses, should be considered.
  - 2) The electrical characteristics given in this specification may be influenced by conditions such as temperature, supply voltage and external components. Transient characteristics should be sufficiently verified.
  - 3) GND electric potential  
Keep the GND pin potential at the lowest (minimum) level under any operating condition. Furthermore, ensure that, including the transient, none of the pin's voltages are less than the GND pin voltage.
  - 4) GND wiring pattern  
When both a small-signal GND and a high current GND are present, single-point grounding (at the set standard point) is recommended. This in order to separate the small-signal and high current patterns and to ensure that voltage changes stemming from the wiring resistance and high current do not cause any voltage change in the small-signal GND. Similarly, care must be taken to avoid wiring pattern fluctuations in any connected external component GND.
  - 5) Inter-pin shorting and mounting errors  
Ensure that when mounting the IC on the PCB the direction and position are correct. Incorrect mounting may result in damaging the IC. Also, shorts caused by dust entering between the output, input and GND pin may result in damaging the IC.
  - 6) Inspection using the set board  
The IC needs to be discharged after each inspection process as, while using the set board for inspection, connecting a capacitor to a low-impedance pin may cause stress to the IC. As a protection from static electricity, ensure that the assembly setup is grounded and take sufficient caution with transportation and storage. Also, make sure to turn off the power supply when connecting and disconnecting the inspection equipment.
  - 7) Power dissipation (Pd)  
Should by any chance the power dissipation rating be exceeded the rise in temperature of the chip may result in deterioration of the properties of the chip. The absolute maximum rating of the Pd stated in this specification is when the IC is mounted on a 70mm X 70mm X 1.6mm glass epoxy board. In case of exceeding this absolute maximum rating, increase the board size and copper area to prevent exceeding the Pd rating.
  - 8) Thermal design  
The power dissipation under actual operating conditions should be taken into consideration and a sufficient margin should be allowed for in the thermal design. On the reverse side of the package this product has an exposed heat pad for improving the heat dissipation. Use both the front and reverse side of the PCB to increase the heat dissipation pattern as far as possible. The amount of heat generated depends on the voltage difference across the input and output, load current, and bias current. Therefore, when actually using the chip, ensure that the generated heat does not exceed the Pd rating.
- (Tjmax: maximum junction temperature=150°C, Ta: ambient temperature (°C), θja: junction-to-ambient thermal resistance (°C /W), Pd: power dissipation rating (W), Pc: power consumption (W), VCC: input voltage, VOUT: output voltage, IOUT: load current, Ib: bias current)
- |                          |   |
|--------------------------|---|
| Power dissipation rating | $Pd (W) = (T_{jmax} - T_a) / \theta_{ja}$           |
| Power consumption        | $Pc (W) = (VCC - VOUT) \times IOUT + VCC \times Ib$ |
- 9) Rapid variation in VCC voltage and load current  
In case of a rapidly changing input voltage, transients in the output voltage might occur due to the use of a MOSFET as output transistor. Although the actual application might be the cause of the transients, the IC input voltage, output current and temperature are also possible causes. In case problems arise within the actual operating range, use countermeasures such as adjusting the output capacitance.
  - 10) Minute variation in output voltage  
In case of using an application susceptible to minute changes to the output voltage due to noise, changes in input and load current, etc., use countermeasures such as implementing filters.
  - 11) Overcurrent protection circuit  
This IC incorporates an integrated overcurrent protection circuit that is activated when the load is shorted. This protection circuit is effective in preventing damage due to sudden and unexpected incidents. However, the IC should not be used in applications characterized by continuous operation or transitioning of the protection circuit.

## 12) Thermal shutdown (TSD)

This IC incorporates an integrated thermal shutdown circuit to prevent heat damage to the IC. Normal operation should be within the power dissipation rating, if however the rating is exceeded for a continued period, the junction temperature ( $T_j$ ) will rise and the TSD circuit will be activated and turn all output pins OFF. After the  $T_j$  falls below the TSD threshold the circuits are automatically restored to normal operation.

Note that the TSD circuit operates in a situation that exceeds the absolute maximum ratings and therefore, under no circumstances, should the TSD circuit be used in a set design or for any purpose other than protecting the IC from heat damage.

13) In some applications, the VCC and pin potential might be reversed, possibly resulting in circuit internal damage or damage to the elements. For example, while the external capacitor is charged, the VCC shorts to the GND. Use a capacitor with a capacitance with less than 1000 $\mu$ F. We also recommend using reverse polarity diodes in series or a bypass between all pins and the VCC pin.

14) This monolithic IC contains P+ isolation and P substrate layers between adjacent elements in order to keep them isolated. P/N junctions are formed at the intersection of these P layers with the N layers of other elements to create a variety of parasitic elements.

For example, in case a resistor and a transistor are connected to the pins as shown in the figure below then:

○ The P/N junction functions as a parasitic diode when  $GND > \text{pin A}$  for the resistor, or  $GND > \text{pin B}$  for the transistor.

○ Also, when  $GND > \text{pin B}$  for the transistor (NPN), the parasitic diode described above combines with the N layer of the other adjacent elements to operate as a parasitic NPN transistor.

Parasitic diodes inevitably occur in the structure of the IC. Their operation can result in mutual interference between circuits and can cause malfunctions and, in turn, physical damage to or destruction of the chip. Therefore do not employ any method in which parasitic diodes can operate such as applying a voltage to an input pin that is lower than the (P substrate) GND.

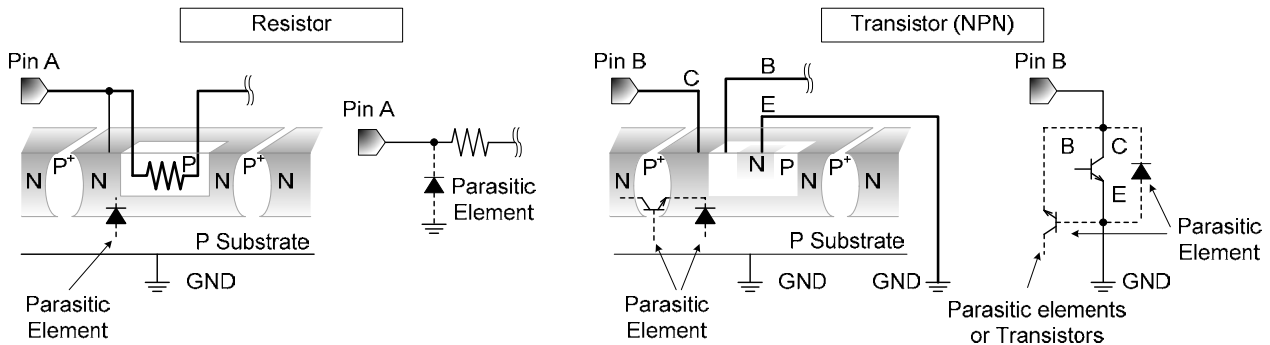
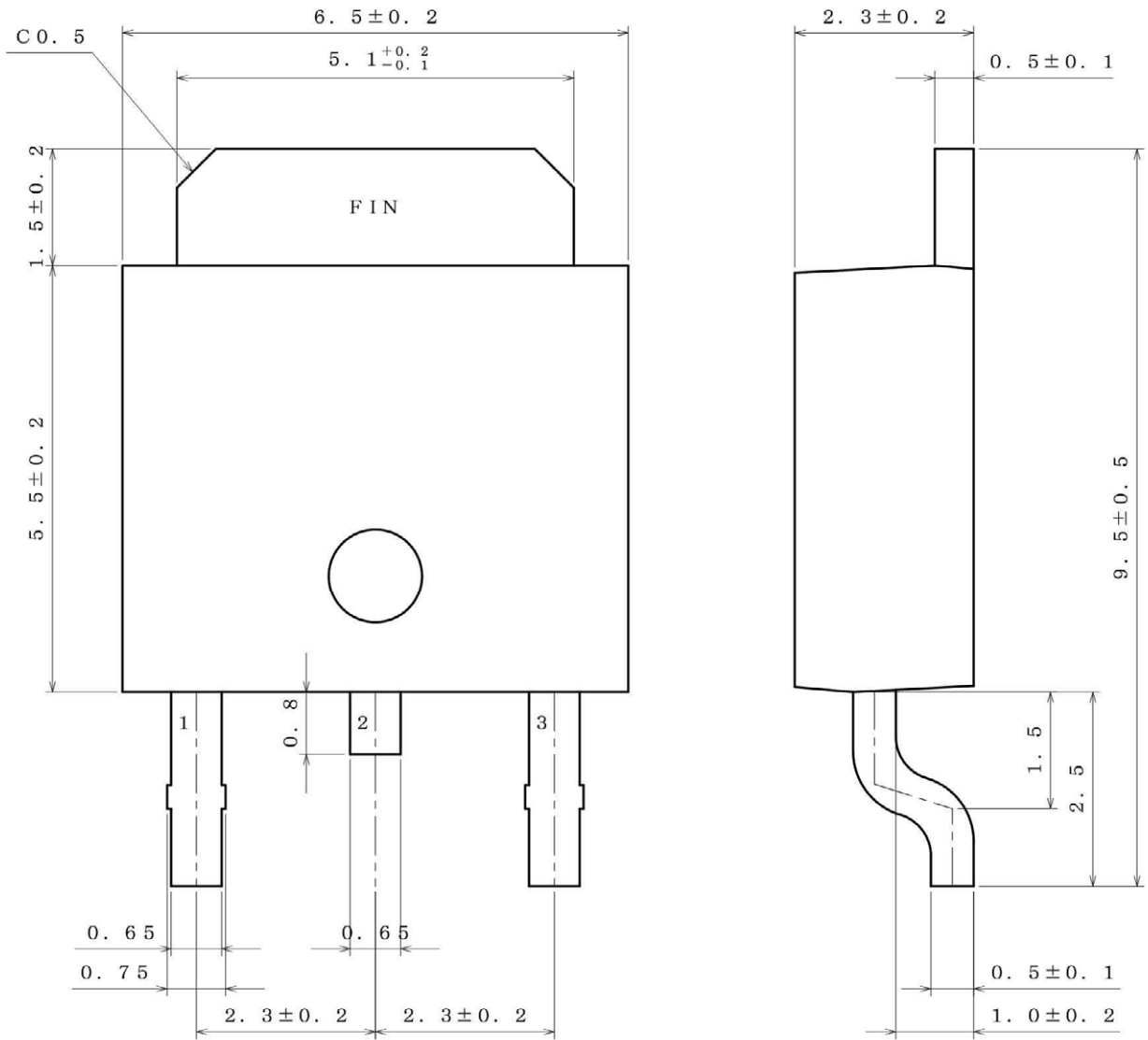

Figure 26. Example of the Parasitic Device Structures

●Physical Dimension, Tape and Reel Information

Package Name	TO252-3
--------------	---------



(UNITS ; mm)

PKG : TO252-3

Drawing No. EX535-5001-1

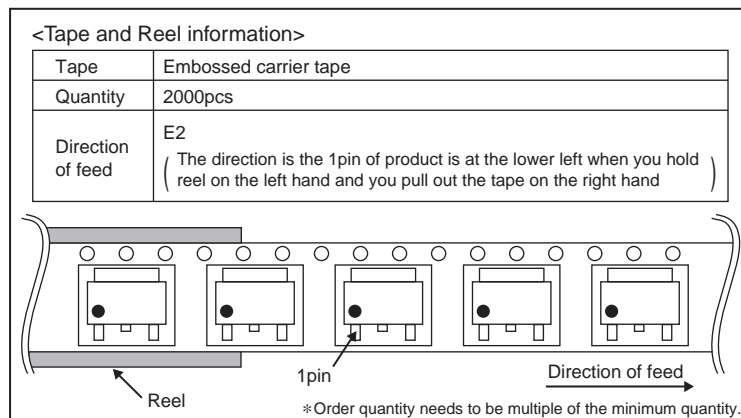

●Marking Diagram (TOP VIEW)

TO252-3

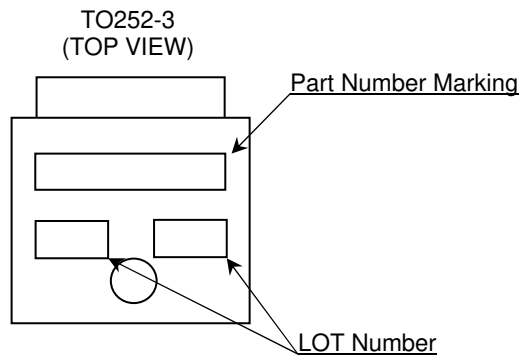

Part Number Marking	Output Voltage (V)
BD733L5	3.3
BD750L5	5.0

●Revision History

Date	Revision	Changes
02.Oct.2012	001	New Release
14.Mar.2013	002	Page 1. Series name is changed. Page 4. Power Dissipation is changed to be compliant with JEDEC standard. Page 4. Append Thermal Resistance $\theta_{ja}$ , $\theta_{jc}$ . Page 6. Figure 5, Page 7. Figure 11 All Quiescent current are integrated into Bias Current. Page 8. Figure 14, Page 9. Figure 15 All Quiescent current are integrated into Bias Current. Page 10. Figure 21, Page 11. Figure 24 All Quiescent current are integrated into Bias Current. Page 14. Figure 25, 26 Power Dissipation is changed to be compliant with JEDEC standard. Page 15, 16. Calculation examples are changed. Page 19. "Application example" is deleted. Figure 29 "Example of the Parasitic Device Structures" is renewed.
30.Sep.2013	003	AEC-Q100 Qualified. Page 21. Physical Quantity is changed.
01.May.2014	004	TO263-3F is changed to the individual registration.

# Notice

## Precaution on using ROHM Products

1. If you intend to use our Products in devices requiring extremely high reliability (such as medical equipment <sup>(Note 1)</sup>, aircraft/spacecraft, nuclear power controllers, etc.) and whose malfunction or failure may cause loss of human life, bodily injury or serious damage to property ("Specific Applications"), please consult with the ROHM sales representative in advance. Unless otherwise agreed in writing by ROHM in advance, ROHM shall not be in any way responsible or liable for any damages, expenses or losses incurred by you or third parties arising from the use of any ROHM's Products for Specific Applications.

(Note1) Medical Equipment Classification of the Specific Applications

JAPAN	USA	EU	CHINA
CLASS III	CLASS III	CLASS II b	CLASS III
CLASS IV		CLASS III	

2. ROHM designs and manufactures its Products subject to strict quality control system. However, semiconductor products can fail or malfunction at a certain rate. Please be sure to implement, at your own responsibilities, adequate safety measures including but not limited to fail-safe design against the physical injury, damage to any property, which a failure or malfunction of our Products may cause. The following are examples of safety measures:
  - [a] Installation of protection circuits or other protective devices to improve system safety
  - [b] Installation of redundant circuits to reduce the impact of single or multiple circuit failure
3. Our Products are not designed under any special or extraordinary environments or conditions, as exemplified below. Accordingly, ROHM shall not be in any way responsible or liable for any damages, expenses or losses arising from the use of any ROHM's Products under any special or extraordinary environments or conditions. If you intend to use our Products under any special or extraordinary environments or conditions (as exemplified below), your independent verification and confirmation of product performance, reliability, etc, prior to use, must be necessary:
  - [a] Use of our Products in any types of liquid, including water, oils, chemicals, and organic solvents
  - [b] Use of our Products outdoors or in places where the Products are exposed to direct sunlight or dust
  - [c] Use of our Products in places where the Products are exposed to sea wind or corrosive gases, including Cl<sub>2</sub>, H<sub>2</sub>S, NH<sub>3</sub>, SO<sub>2</sub>, and NO<sub>2</sub>
  - [d] Use of our Products in places where the Products are exposed to static electricity or electromagnetic waves
  - [e] Use of our Products in proximity to heat-producing components, plastic cords, or other flammable items
  - [f] Sealing or coating our Products with resin or other coating materials
  - [g] Use of our Products without cleaning residue of flux (even if you use no-clean type fluxes, cleaning residue of flux is recommended); or Washing our Products by using water or water-soluble cleaning agents for cleaning residue after soldering
  - [h] Use of the Products in places subject to dew condensation
4. The Products are not subject to radiation-proof design.
5. Please verify and confirm characteristics of the final or mounted products in using the Products.
6. In particular, if a transient load (a large amount of load applied in a short period of time, such as pulse. is applied, confirmation of performance characteristics after on-board mounting is strongly recommended. Avoid applying power exceeding normal rated power; exceeding the power rating under steady-state loading condition may negatively affect product performance and reliability.
7. De-rate Power Dissipation (Pd) depending on Ambient temperature (Ta). When used in sealed area, confirm the actual ambient temperature.
8. Confirm that operation temperature is within the specified range described in the product specification.
9. ROHM shall not be in any way responsible or liable for failure induced under deviant condition from what is defined in this document.

## Precaution for Mounting / Circuit board design

1. When a highly active halogenous (chlorine, bromine, etc.) flux is used, the residue of flux may negatively affect product performance and reliability.
2. In principle, the reflow soldering method must be used; if flow soldering method is preferred, please consult with the ROHM representative in advance.

For details, please refer to ROHM Mounting specification

### Precautions Regarding Application Examples and External Circuits

1. If change is made to the constant of an external circuit, please allow a sufficient margin considering variations of the characteristics of the Products and external components, including transient characteristics, as well as static characteristics.
2. You agree that application notes, reference designs, and associated data and information contained in this document are presented only as guidance for Products use. Therefore, in case you use such information, you are solely responsible for it and you must exercise your own independent verification and judgment in the use of such information contained in this document. ROHM shall not be in any way responsible or liable for any damages, expenses or losses incurred by you or third parties arising from the use of such information.

### Precaution for Electrostatic

This Product is electrostatic sensitive product, which may be damaged due to electrostatic discharge. Please take proper caution in your manufacturing process and storage so that voltage exceeding the Products maximum rating will not be applied to Products. Please take special care under dry condition (e.g. Grounding of human body / equipment / solder iron, isolation from charged objects, setting of ionizer, friction prevention and temperature / humidity control).

### Precaution for Storage / Transportation

1. Product performance and soldered connections may deteriorate if the Products are stored in the places where:
  - [a] the Products are exposed to sea winds or corrosive gases, including Cl<sub>2</sub>, H<sub>2</sub>S, NH<sub>3</sub>, SO<sub>2</sub>, and NO<sub>2</sub>
  - [b] the temperature or humidity exceeds those recommended by ROHM
  - [c] the Products are exposed to direct sunshine or condensation
  - [d] the Products are exposed to high Electrostatic
2. Even under ROHM recommended storage condition, solderability of products out of recommended storage time period may be degraded. It is strongly recommended to confirm solderability before using Products of which storage time is exceeding the recommended storage time period.
3. Store / transport cartons in the correct direction, which is indicated on a carton with a symbol. Otherwise bent leads may occur due to excessive stress applied when dropping of a carton.
4. Use Products within the specified time after opening a humidity barrier bag. Baking is required before using Products of which storage time is exceeding the recommended storage time period.

### Precaution for Product Label

QR code printed on ROHM Products label is for ROHM's internal use only.

### Precaution for Disposition

When disposing Products please dispose them properly using an authorized industry waste company.

### Precaution for Foreign Exchange and Foreign Trade act

Since our Products might fall under controlled goods prescribed by the applicable foreign exchange and foreign trade act, please consult with ROHM representative in case of export.

### Precaution Regarding Intellectual Property Rights

1. All information and data including but not limited to application example contained in this document is for reference only. ROHM does not warrant that foregoing information or data will not infringe any intellectual property rights or any other rights of any third party regarding such information or data. ROHM shall not be in any way responsible or liable for infringement of any intellectual property rights or other damages arising from use of such information or data.:
2. No license, expressly or implied, is granted hereby under any intellectual property rights or other rights of ROHM or any third parties with respect to the information contained in this document.

### Other Precaution

1. This document may not be reprinted or reproduced, in whole or in part, without prior written consent of ROHM.
2. The Products may not be disassembled, converted, modified, reproduced or otherwise changed without prior written consent of ROHM.
3. In no event shall you use in any way whatsoever the Products and the related technical information contained in the Products or this document for any military purposes, including but not limited to, the development of mass-destruction weapons.
4. The proper names of companies or products described in this document are trademarks or registered trademarks of ROHM, its affiliated companies or third parties.

**General Precaution**

1. Before you use our Products, you are requested to carefully read this document and fully understand its contents. ROHM shall not be in any way responsible or liable for failure, malfunction or accident arising from the use of any ROHM's Products against warning, caution or note contained in this document.
2. All information contained in this document is current as of the issuing date and subject to change without any prior notice. Before purchasing or using ROHM's Products, please confirm the latest information with a ROHM sales representative.
3. The information contained in this document is provided on an "as is" basis and ROHM does not warrant that all information contained in this document is accurate and/or error-free. ROHM shall not be in any way responsible or liable for any damages, expenses or losses incurred by you or third parties resulting from inaccuracy or errors of or concerning such information.