

THIS DOCUMENT IS SUBJECT TO CHANGE WITHOUT NOTICE. IT IS CONFIDENTIAL AND A PROPERTY OF AMPHENOL LTW. DISCLOSURE TO THIRD PARTY HAS TO BE AUTHORIZED BY AMPHENOL LTW.

REV.	ECN NO.	DATE	SIGN	DESCRIPTION
A		2022/09/30	Eagle	Rev.01 to Rev.A

DT-HCN-XXRMM-RHA30

For 12P

- G3: 3Pin
- G4: 4Pin
- G6: 6Pin
- 08: 8Pin
- 12: 12Pin

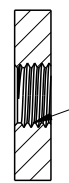
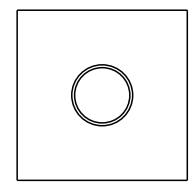
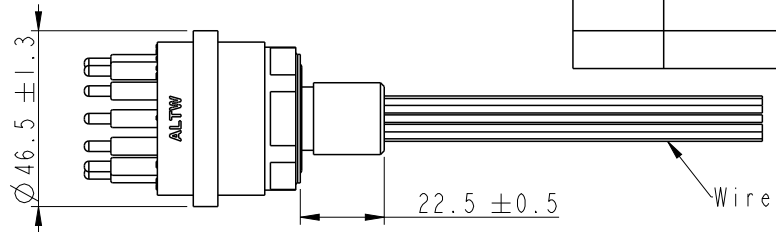

6.40 (Min.)/11.1 (Max.)

Panel cut out (screw type)

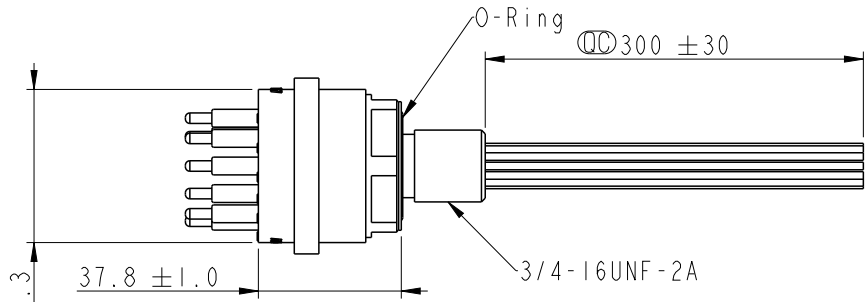
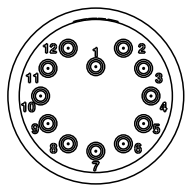

$\phi 20.5 \pm 0.1$

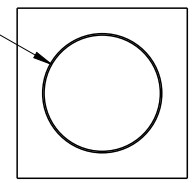

R0.25 (Max.)

6.40 (Min.)/11.1 (Max.)

Panel cut out (hole type)

☉ Date Code (Laser mark)
YY (年)
WW (週)
上下左右置中

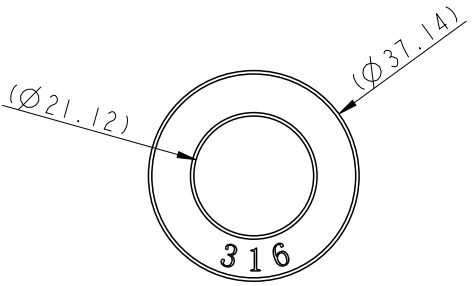

Washer

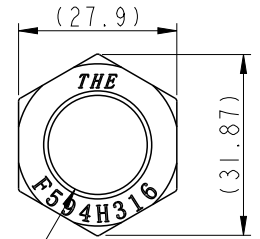

Nut

Note:

- * ☉ Important Dimension.
- * Waterproof Rate: Hadopelagic 7000M, Mated.
- * Connector
Housing : Rubber, Black.
Pin : Copper Alloy, Gold Plated.
O-Ring: Rubber, Black.
Shield: Metal.
Nut: Metal.
Washer: Metal.
- * Wire: UL10393 18 AWG, OD 1.81mm
- * Washer and nut are packed separately in PE bag.

UNIT: mm		
TOLERANCE ±0.5		

TITLE DT, HAD CIRCULAR MINI REAR FASTENED, M, M			
SCALE 1:1	SIZE A4	SHEET 1 OF 5	
REV. A	WC-REV. A.5	☉ Inspection item	

Amphenol LTW
安費諾亮泰企業股份有限公司

ITEM NO.	DRAWN BY Eagle	DATE 2022/09/30
DWG NO. DT-HCN-XXRMM-RHA30	CHECKED BY Aric	DATE 2022/09/30
CUSTOMER ALTW	APPROVED BY Max	DATE 2022/09/30

THIS DOCUMENT IS SUBJECT TO CHANGE WITHOUT NOTICE. IT IS CONFIDENTIAL AND A PROPERTY OF AMPHENOL LTW. DISCLOSURE TO THIRD PARTY HAS TO BE AUTHORIZED BY AMPHENOL LTW.

For 6P/8P

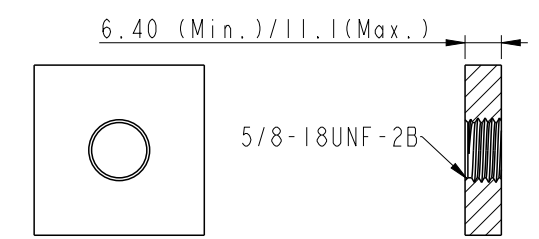
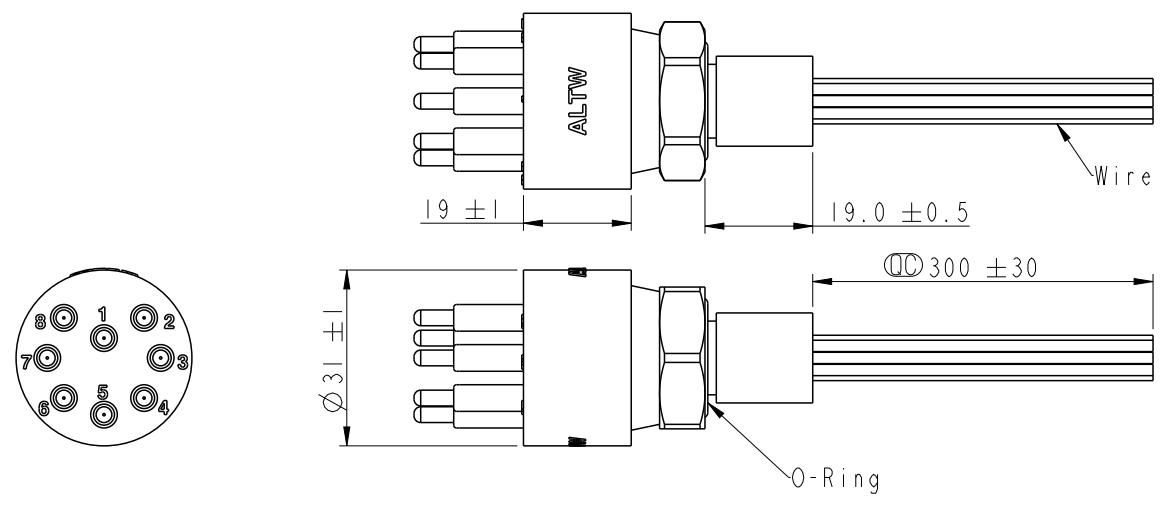

Panel cut out (screw type)

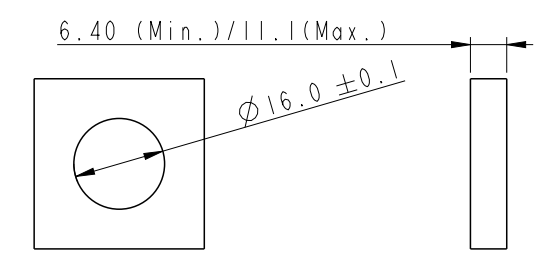

Panel cut out (hole type)

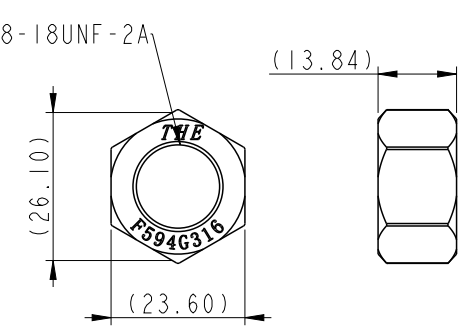
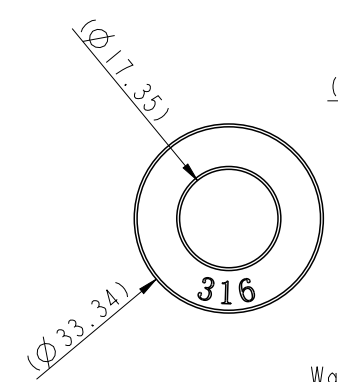
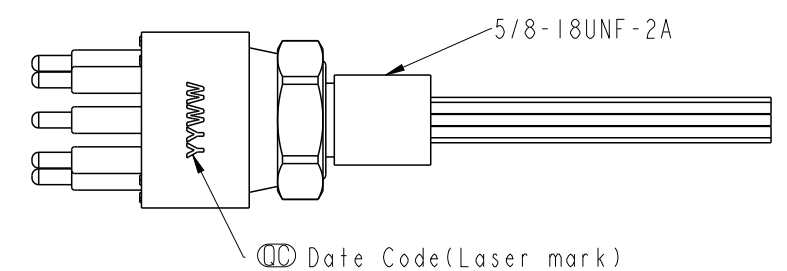
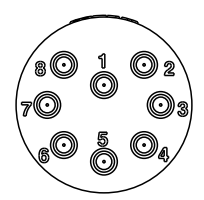

UNIT: mm TOLERANCE ±0.5	TITLE DT, HAD CIRCULAR MINI REAR FASTENED, M, M		Amphenol LTW 安費諾亮泰企業股份有限公司		ITEM NO	DRAWN BY Eagle	DATE 2022/09/30
	SCALE 1:1	SIZE A4	SHEET 2	OF 5	DWG NO DT-HCN-XXRMM-RHA30	CHECKED BY Aric	DATE 2022/09/30
	REV. A	WC-REV. A.5	QC: Inspection item		CUSTOMER ALTW	APPROVED BY Max	DATE 2022/09/30

THIS DOCUMENT IS SUBJECT TO CHANGE WITHOUT NOTICE. IT IS CONFIDENTIAL AND A PROPERTY OF Amphenol LTW. DISCLOSURE TO THIRD PARTY HAS TO BE AUTHORIZED BY Amphenol LTW.

For 3P/4P

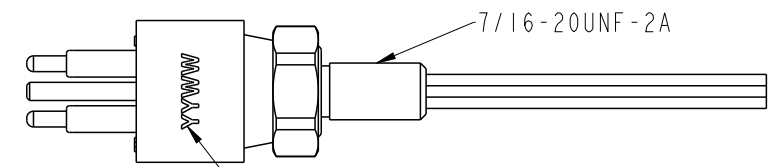
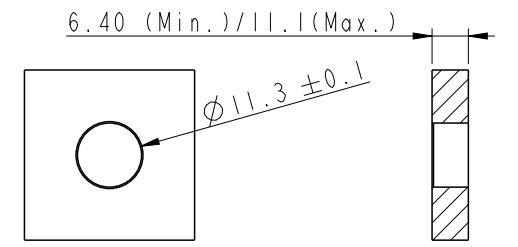
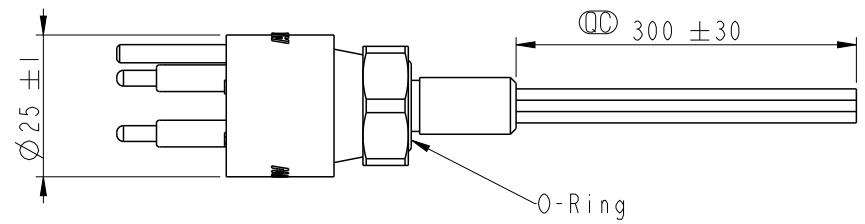
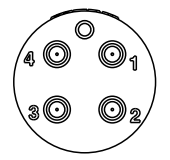
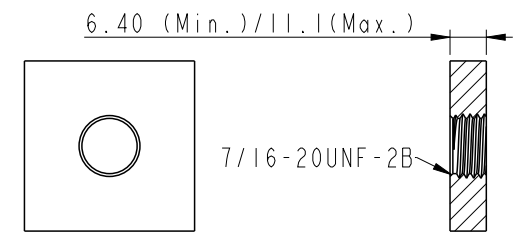
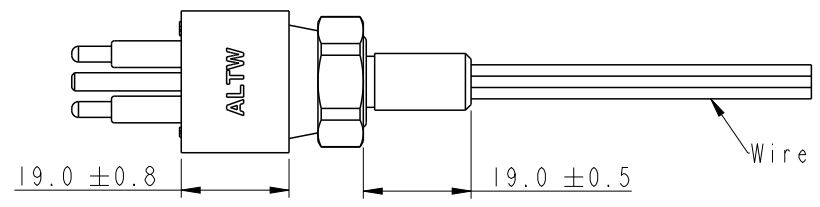

☉ Date Code(Laser mark)
YY(年)
WW(週)

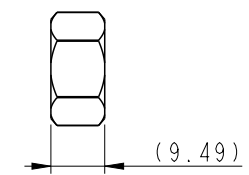
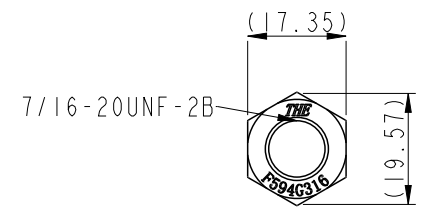
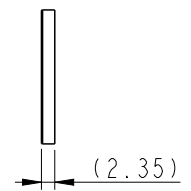
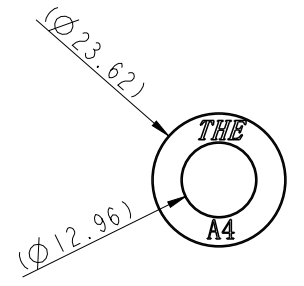

Washer

Nut

UNIT:mm		
TOLERANCE ±0.5		

TITLE DT, HAD CIRCULAR MINI REAR FASTENED, M, M			
SCALE 1:1	SIZE A4	SHEET 3 OF 5	
REV. A	WC-REV. A.5	☉: Inspection item	

Amphenol LTW
安費諾亮泰企業股份有限公司

ITEM NO	DWG NO DT-HCN-XXRMM-RHA30
CUSTOMER ALTW	

DRAWN BY Eagle	CHECKED BY Aric
APPROVED BY Max	

DATE 2022/09/30	DATE 2022/09/30
DATE 2022/09/30	DATE 2022/09/30

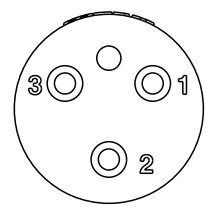

Pin Assignment(Front View)

- Pin Out (3P)
 1 Black(黑) 18AWG
 2 White(白) 18AWG
 3 Red(紅) 18AWG

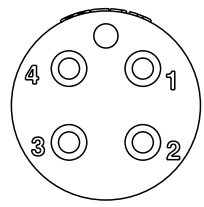

Pin Assignment(Front View)

- Pin Out (4P)
 1 Black(黑) 18AWG
 2 White(白) 18AWG
 3 Red(紅) 18AWG
 4 Green(綠) 18AWG

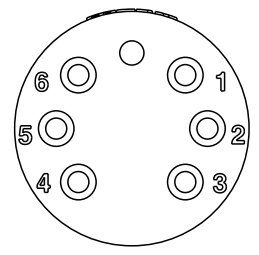

Pin Assignment(Front View)

- Pin Out (6P)
 1 Black(黑) 18AWG
 2 White(白) 18AWG
 3 Red(紅) 18AWG
 4 Green(綠) 18AWG
 5 Orange(橙) 18AWG
 6 Blue(藍) 18AWG

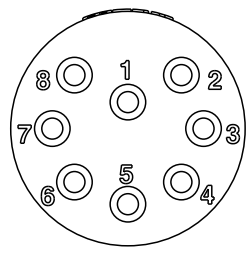

Pin Assignment(Front View)

- Pin Out (8P)
 1 Black(黑) 18AWG
 2 White(白) 18AWG
 3 Red(紅) 18AWG
 4 Green(綠) 18AWG
 5 Orange(橙) 18AWG
 6 Blue(藍) 18AWG
 7 White/Black(白/黑) 18AWG
 8 Red/Black(紅/黑) 18AWG

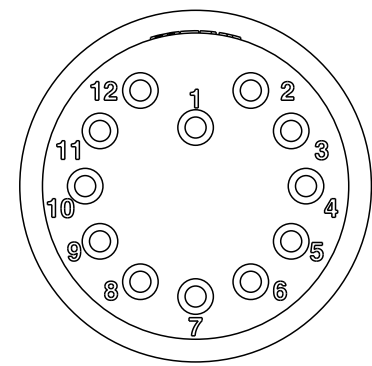

Pin Assignment(Front View)

- Pin Out (12P)
 1 Black(黑) 18AWG
 2 White(白) 18AWG
 3 Red(紅) 18AWG
 4 Green(綠) 18AWG
 5 Orange(橙) 18AWG
 6 Blue(藍) 18AWG
 7 White/Black(白/黑) 18AWG
 8 Red/Black(紅/黑) 18AWG
 9 Green/Black(綠/黑) 18AWG
 10 Orange/Black(橙/黑) 18AWG
 11 Blue/Black(藍/黑) 18AWG
 12 Black/White(黑/白) 18AWG

UNIT:mm
 TOLERANCE

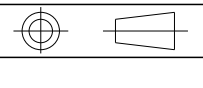

TITLE DT, HAD CIRCULAR MINI REAR FASTENED, M, M

Amphenol LTW

安費諾亮泰企業股份有限公司

ITEM NO
 DWG NO DT-HCN-XXRMM-RHA30
 CUSTOMER ALTW

DRAWN BY Eagle
 CHECKED BY Aric
 APPROVED BY Max

DATE 2022/09/30
 DATE 2022/09/30
 DATE 2022/09/30

SCALE 1:2
 SIZE A4
 SHEET 4 OF 5
 REV. A
 WC-REV.
 Inspection item

THIS DOCUMENT IS SUBJECT TO CHANGE WITHOUT NOTICE. IT IS CONFIDENTIAL AND A PROPERTY OF Amphenol LTW. DISCLOSURE TO THIRD PARTY HAS TO BE AUTHORIZED BY Amphenol LTW.

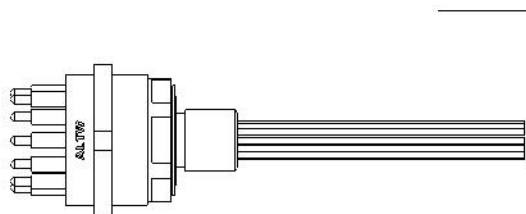

3P/4P/6P/8P: 10PCS(Max.)
12P: 8PCS(Max.)

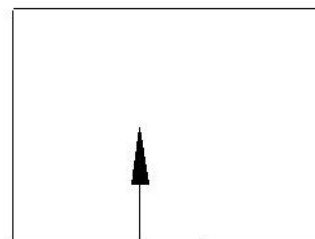

Tray

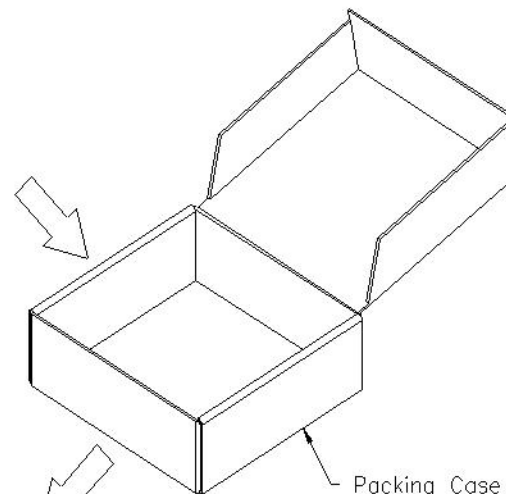

Packing Case

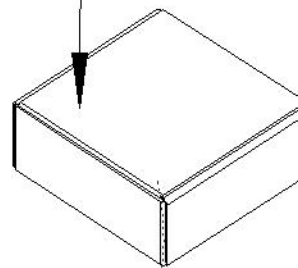

年 月 ALTW 合格品 RoHS2.0

料號: _____ 廠商: 昆山安費諾正日電子



數量: _____ PC 日期: _____

Lot No: _____ 版本: _____



採購單號: _____



廠商料號: _____

UNIT: mm

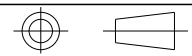

TITLE DT, HAD CIRCULAR MINI REAR FASTENED, M, M			
SCALE 1:1	SIZE A4	SHEET 5 OF 5	
REV. A	WC-REV. A.5	QC: Inspection item	

Amphenol LTW
安費諾亮泰企業股份有限公司

ITEM NO	DRAWN BY Eagle	DATE 2022/09/30
DWG NO DT-HCN-XXRMM-RHA30	CHECKED BY Aric	DATE 2022/09/30
CUSTOMER ALTW	APPROVED BY Max	DATE 2022/09/30