

## DETAILS

<b>Product Number</b>	FCN13552_CRYSTAL-RS
<b>Family</b>	Crystal
<b>Type</b>	Pack
<b>Color</b>	white
<b>Diameter</b>	49,7 mm
<b>Height</b>	28,7 mm
<b>Style</b>	round
<b>Optic Material</b>	PMMA
<b>Holder Material</b>	
<b>Fastening</b>	pin, screw
<b>Status</b>	production ready
<b>ROHS Compliant</b>	Yes
<b>Date Updated</b>	23/01/2018



## OPTICAL PROPERTIES

LED	Viewing	Light	Effi-	cd/lm	Connector
	Angle	Beam	ciency		
XP-G	4,9 deg	Real spot	89 %	68.290	-
XP-L	7 deg	Real spot	88 %	34.700	-
XHP35 HI	5,7 deg	Real spot	89 %	48.300	-
XQ-E HI	2,9 deg	Real spot	88 %	110.500	-
XP-L HI	sim: 5,6	Real spot	sim: 94 %	sim: 70.220	-
LUXEON A	5,1 deg	Real spot	89 %	58.900	-
LUXEON Z ES	3 deg	Real spot	93 %	103.780	-
NVSxx19B/NVSxx19C	5,3 deg	Real spot	89 %	42.500	-
NWSx229A	8 deg	Real spot	92 %	27.900	-
NV4x144A	12 deg	Real spot	92 %	14.200	-
NVSW3x9A	6 deg	Real spot	89 %	36.500	-
LH351Z	4,4 deg	Real spot	90 %	77.000	-
LH351B	5,3 deg	Real spot	90 %	57.030	-

Relative intensity of CN13552\_CRYSTAL-RS\_(XHP35\_HI)

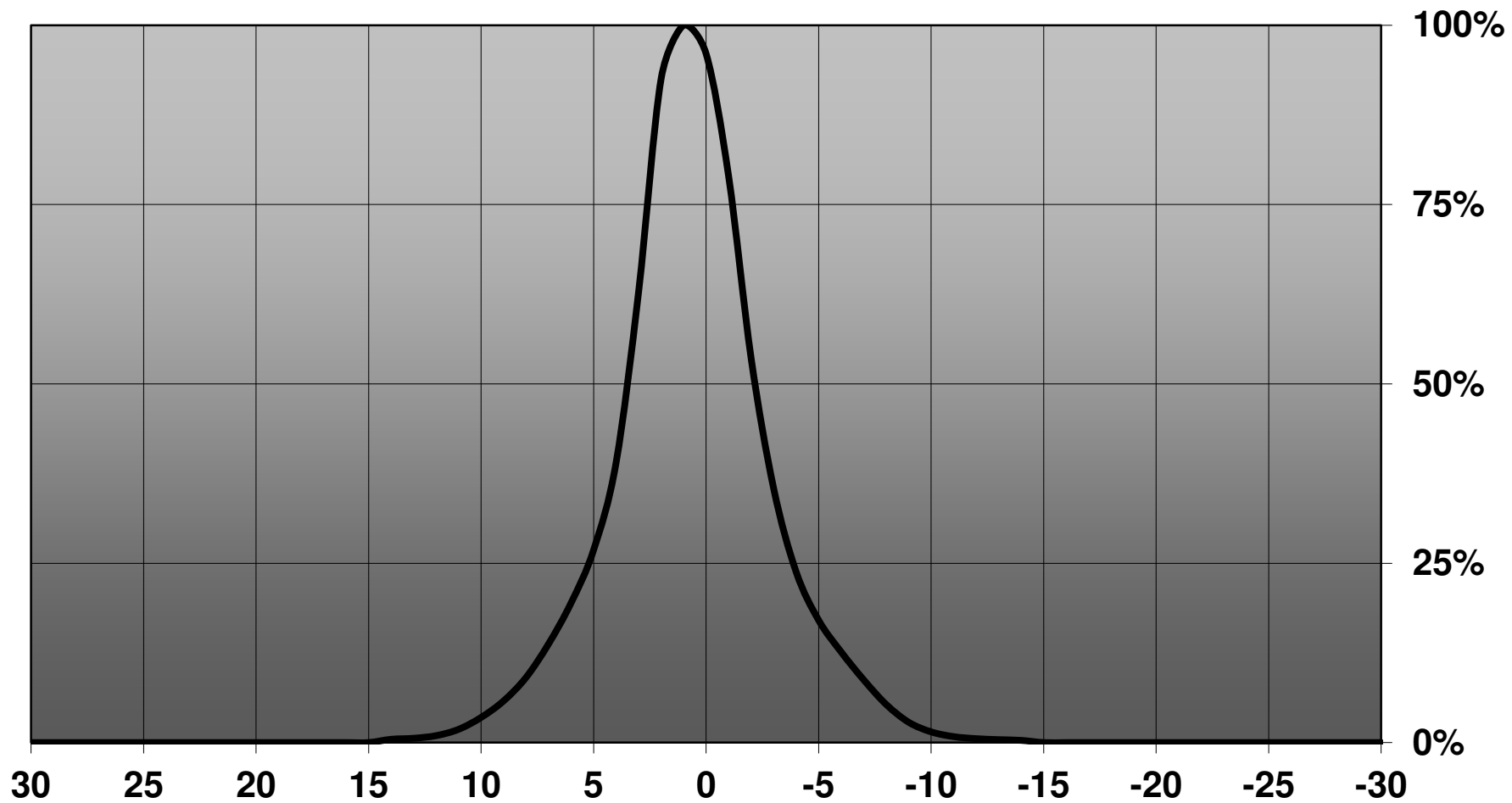

Relative intensity of CN13552\_CRYSTAL-RS\_(XQ-E\_HI)

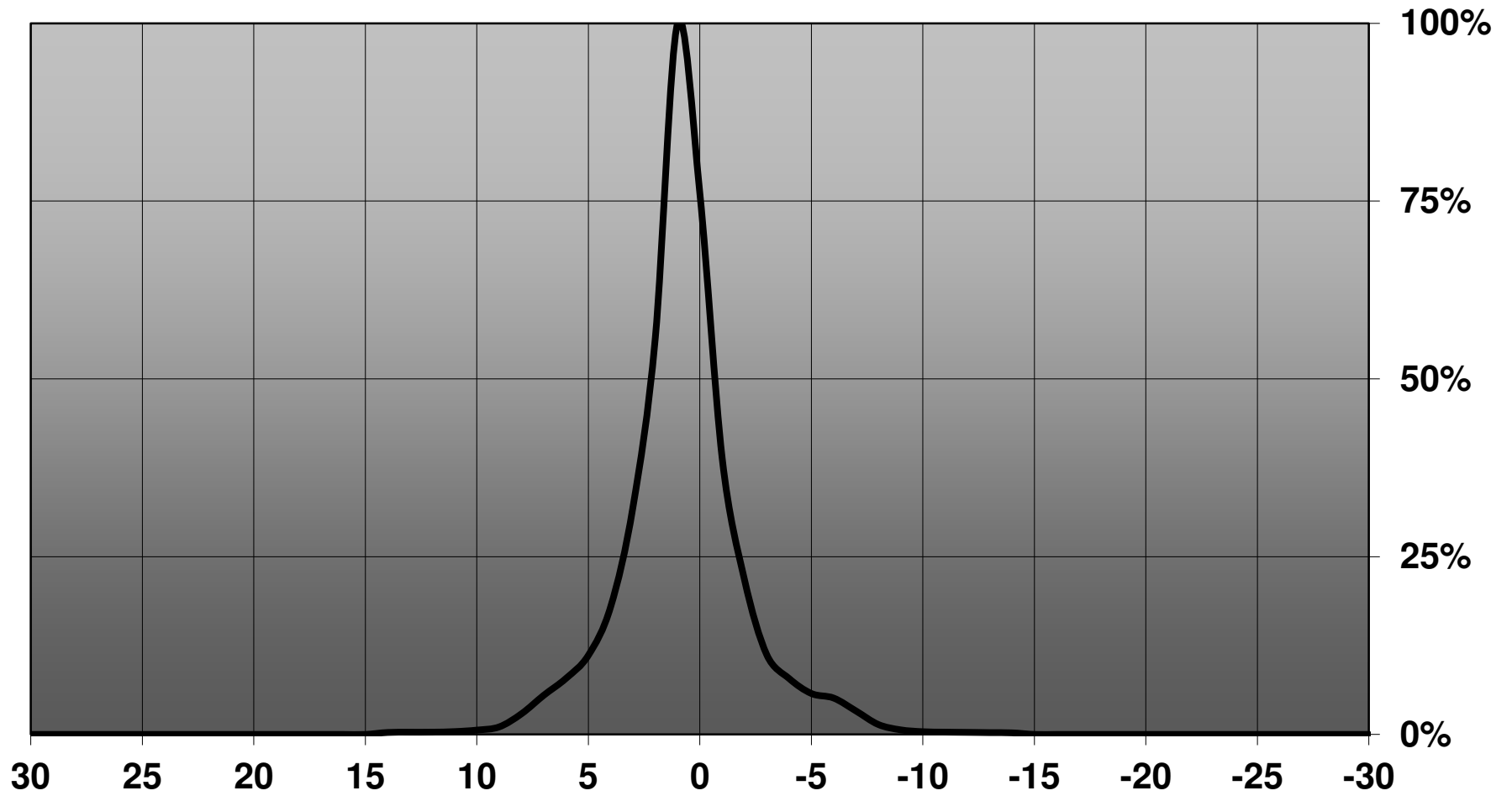

Relative intensity of CN13552\_CRYSTAL-RS\_(Luxeon\_A)

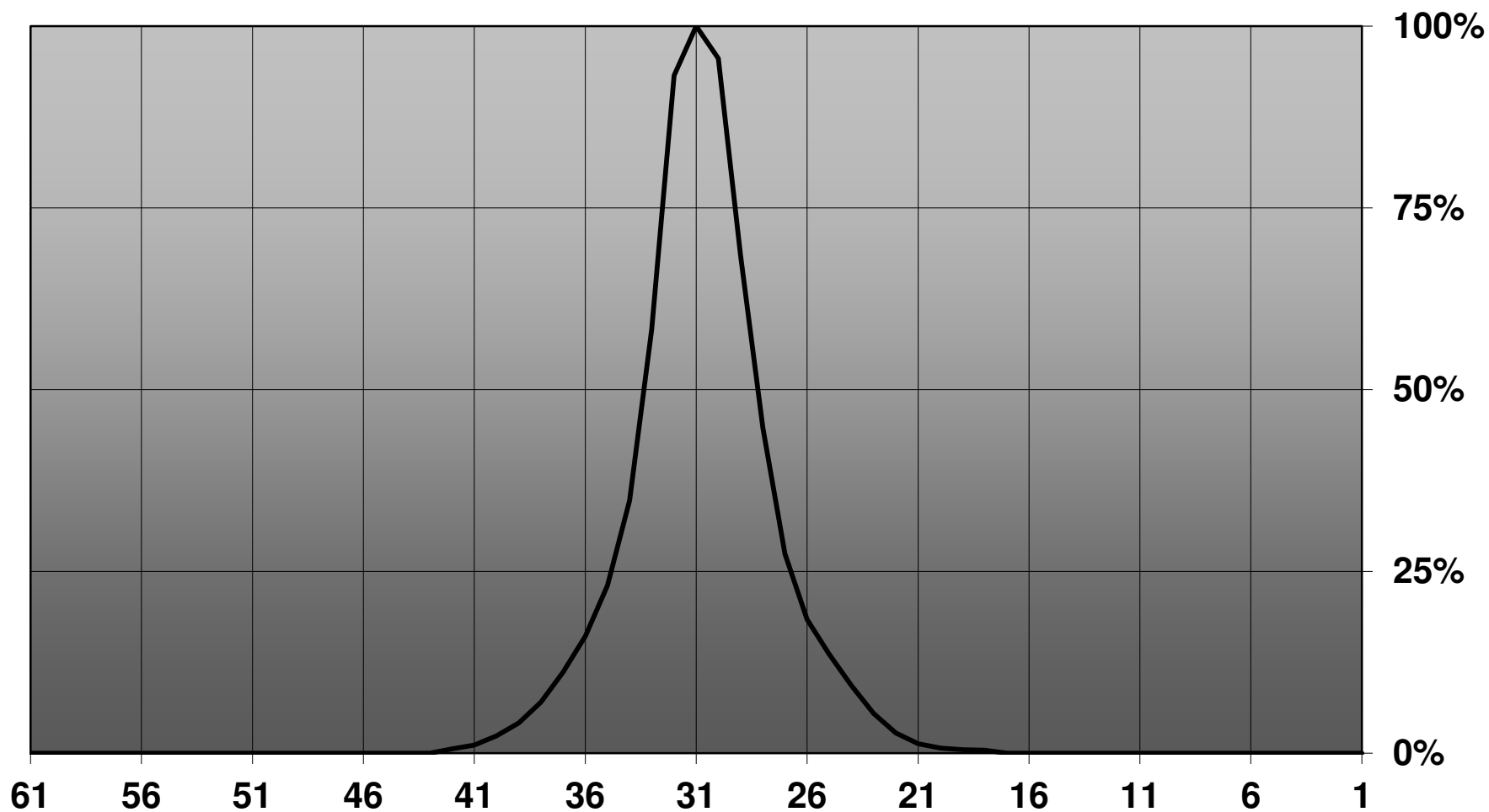

— 0-180

Relative intensity of CN13552\_CRYSTAL-RS\_(NVSxx19B)

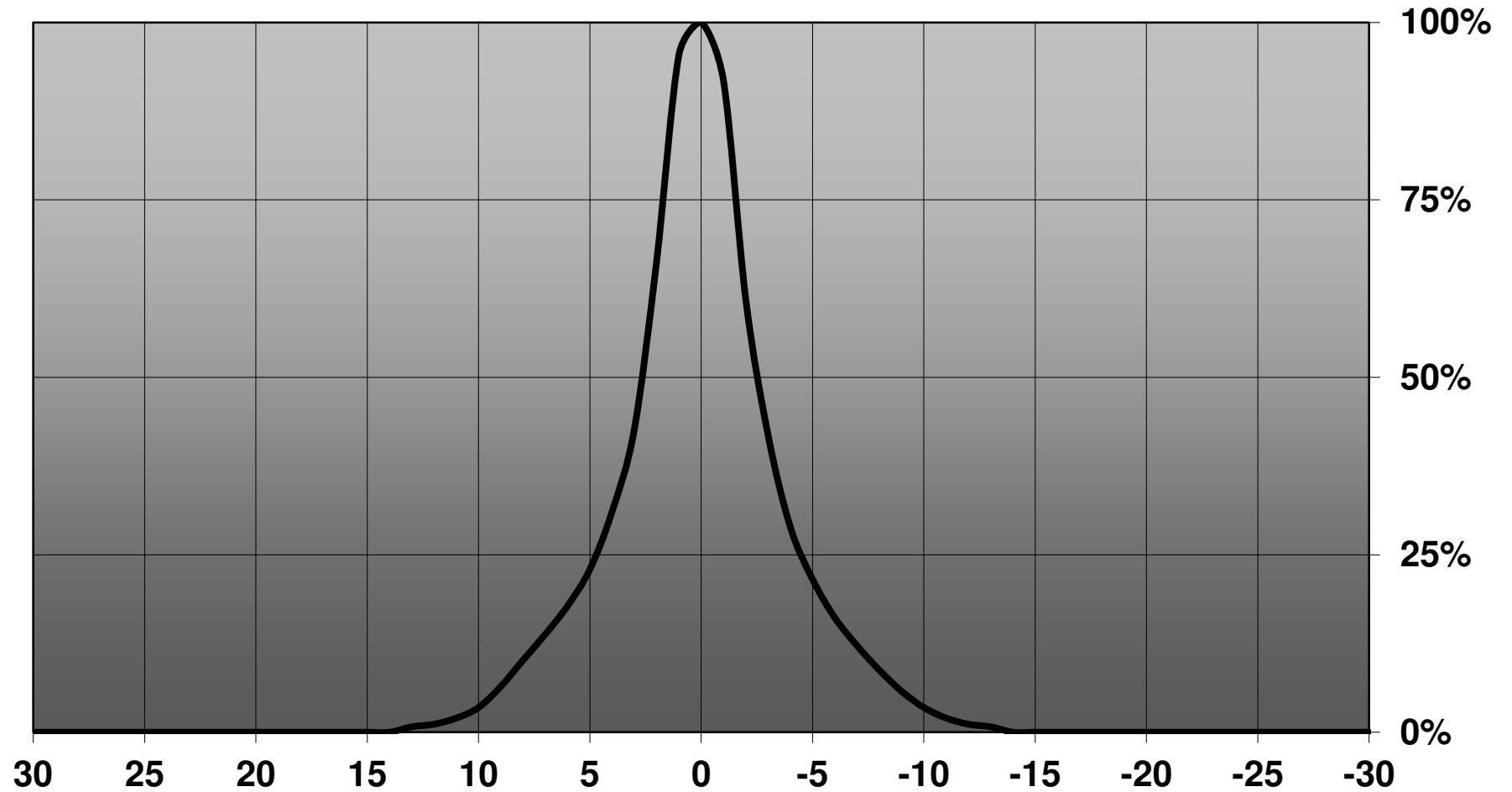

—1

# Relative intensity of CN13552\_CRYSTAL-RS\_(LH351Z)

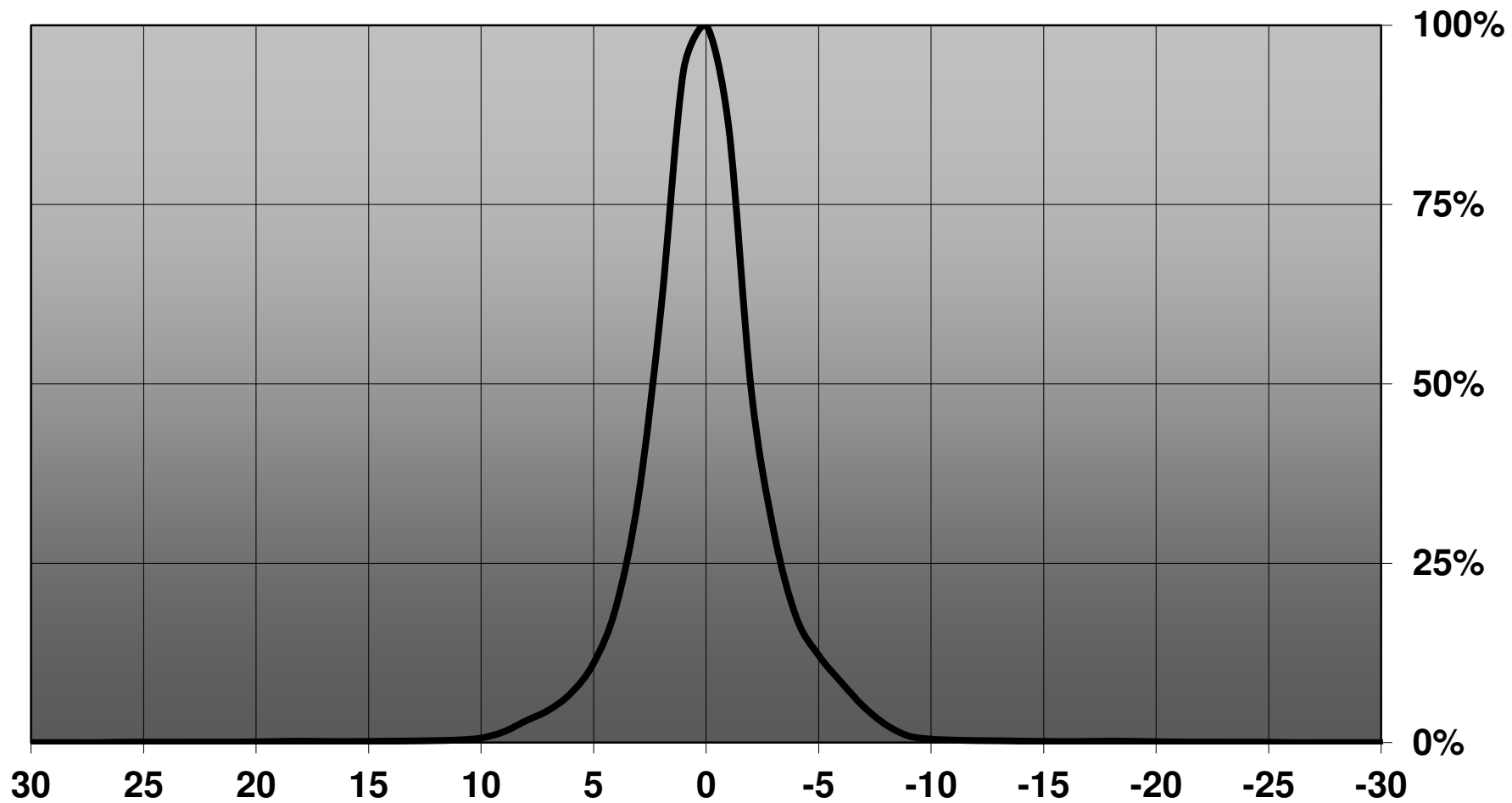

— 1: 0-180

Relative intensity of CN13552\_CRYSTAL-RS\_(LH351B)

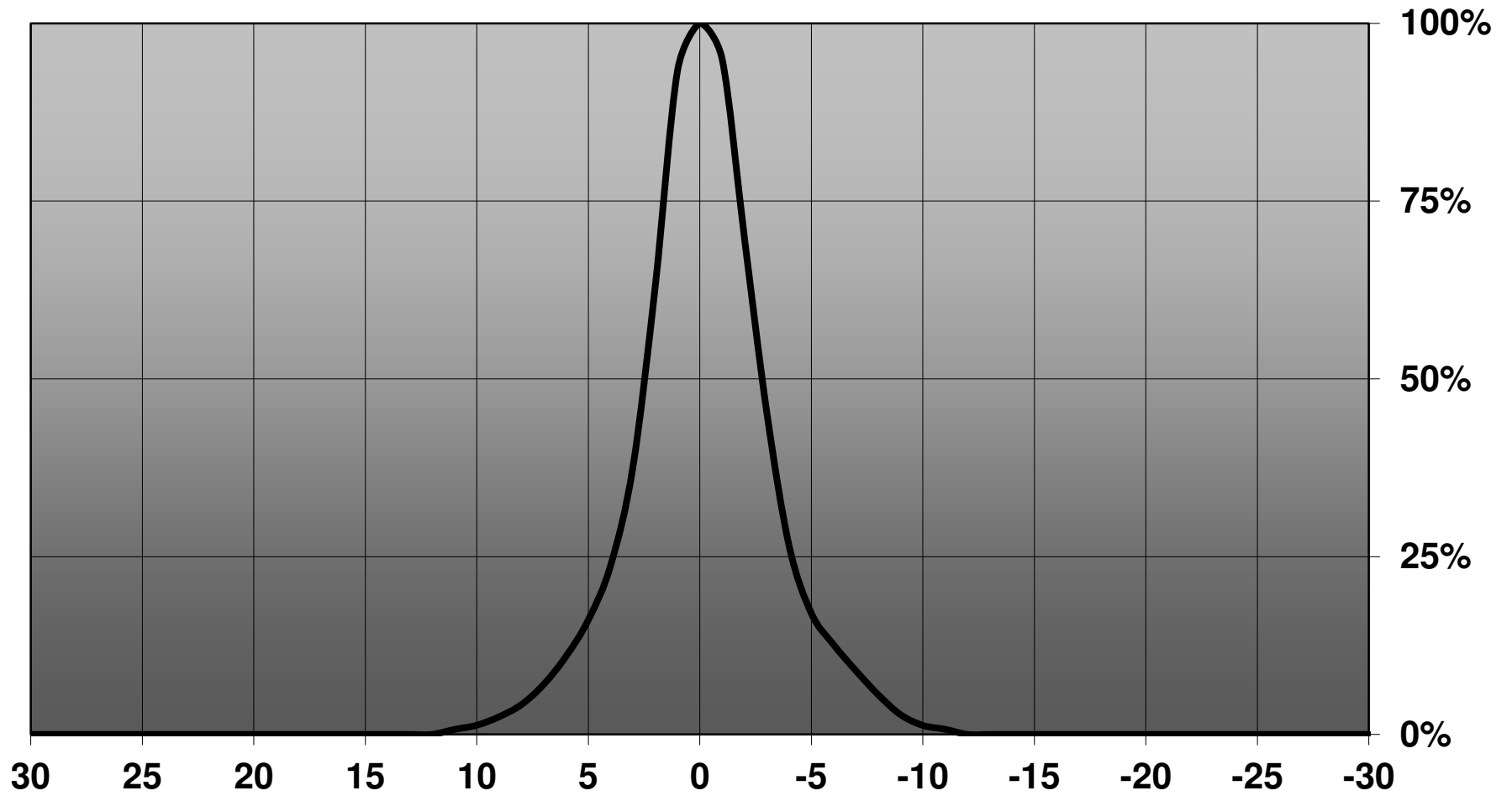

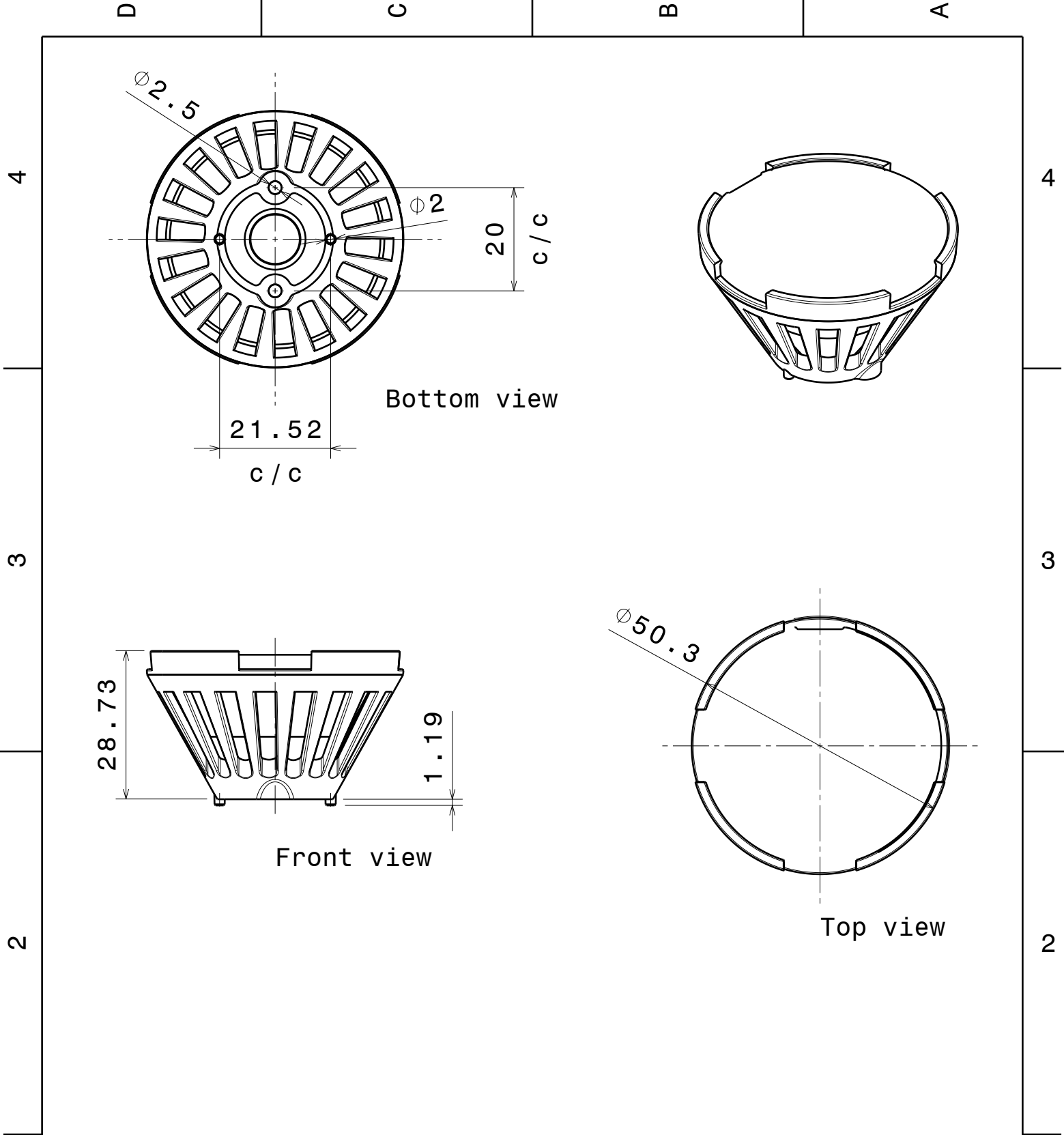

Tolerances if not otherwise shown  
 According to DIN ISO 2768-1  
 Linear measures: class C  
 According to DIN ISO 2768-2  
 Form and position: class L

**LEDiL** LediL Oy  
 Salorankatu 10  
 FIN 24240 SALO  
 Finland

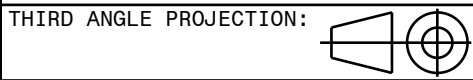

DRAWING TITLE  
**Crystal Assembly MechDrawing**

This drawing is the property of LEDiL Oy. It may not be reproduced, copied or communicated without a written agreement with LEDiL Oy.

SIZE	PART NUMBER
A4	-

SCALE	1:1	WEIGHT	-	SHEET	1/1
-------	-----	--------	---	-------	-----



# Ledil CN13552\_CRYSTAL-RS\_(XP-L) / LDC (Linear)

Luminaire: Ledil CN13552\_CRYSTAL-RS\_(XP-L)  
Lamps: 1 x CREE\_XP-L\_(XPLAWT-0-7A3-U50-0H-0001)  
\_107.852lm@250mA\_CCT=3185K\_P=0.7W\_I=0.25A

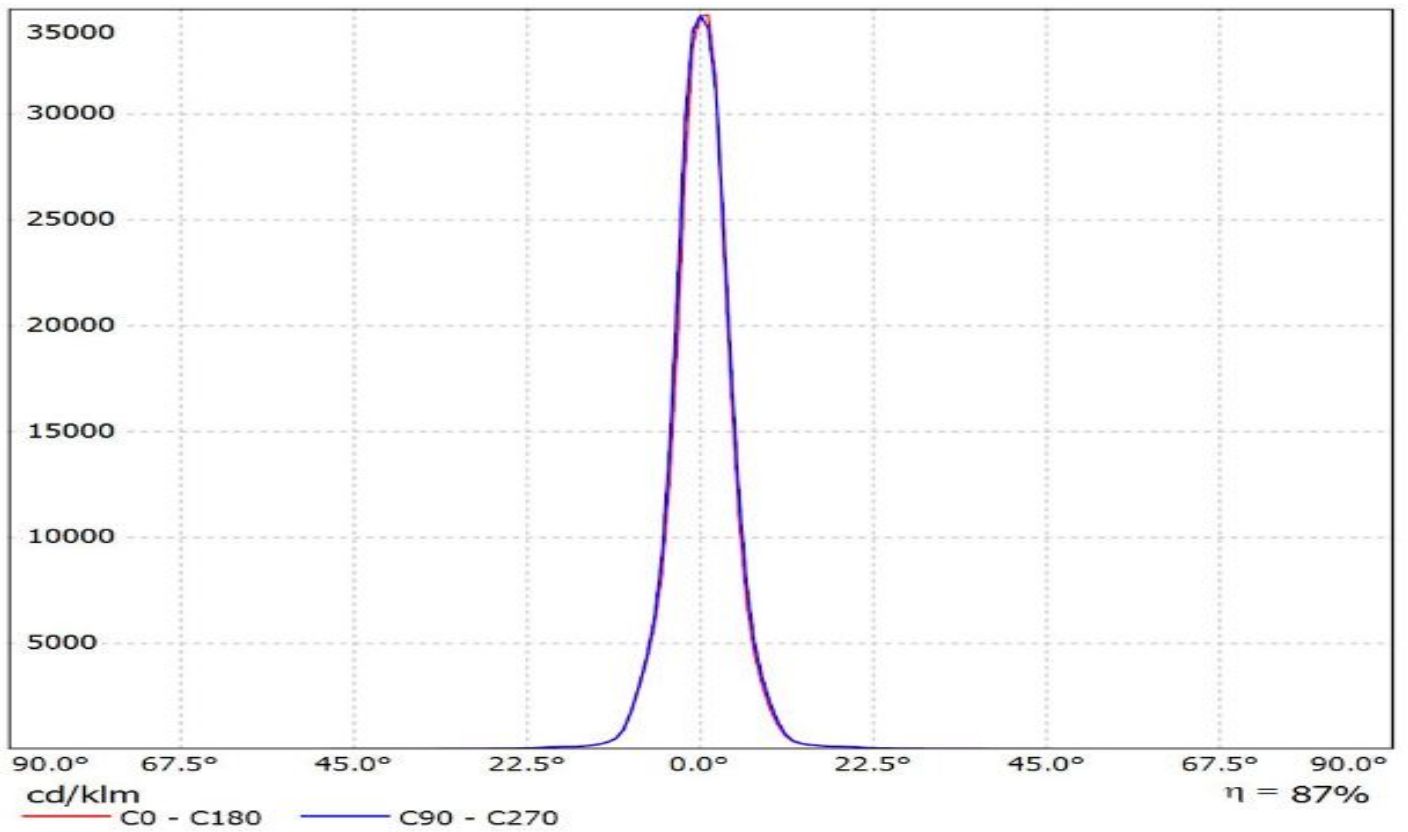

Luminaire: Ledil Oy FCN13552\_CRYSTAL-RS\_SIMULATED  
Lamps: 1 x CREE\_XHP35\_HI

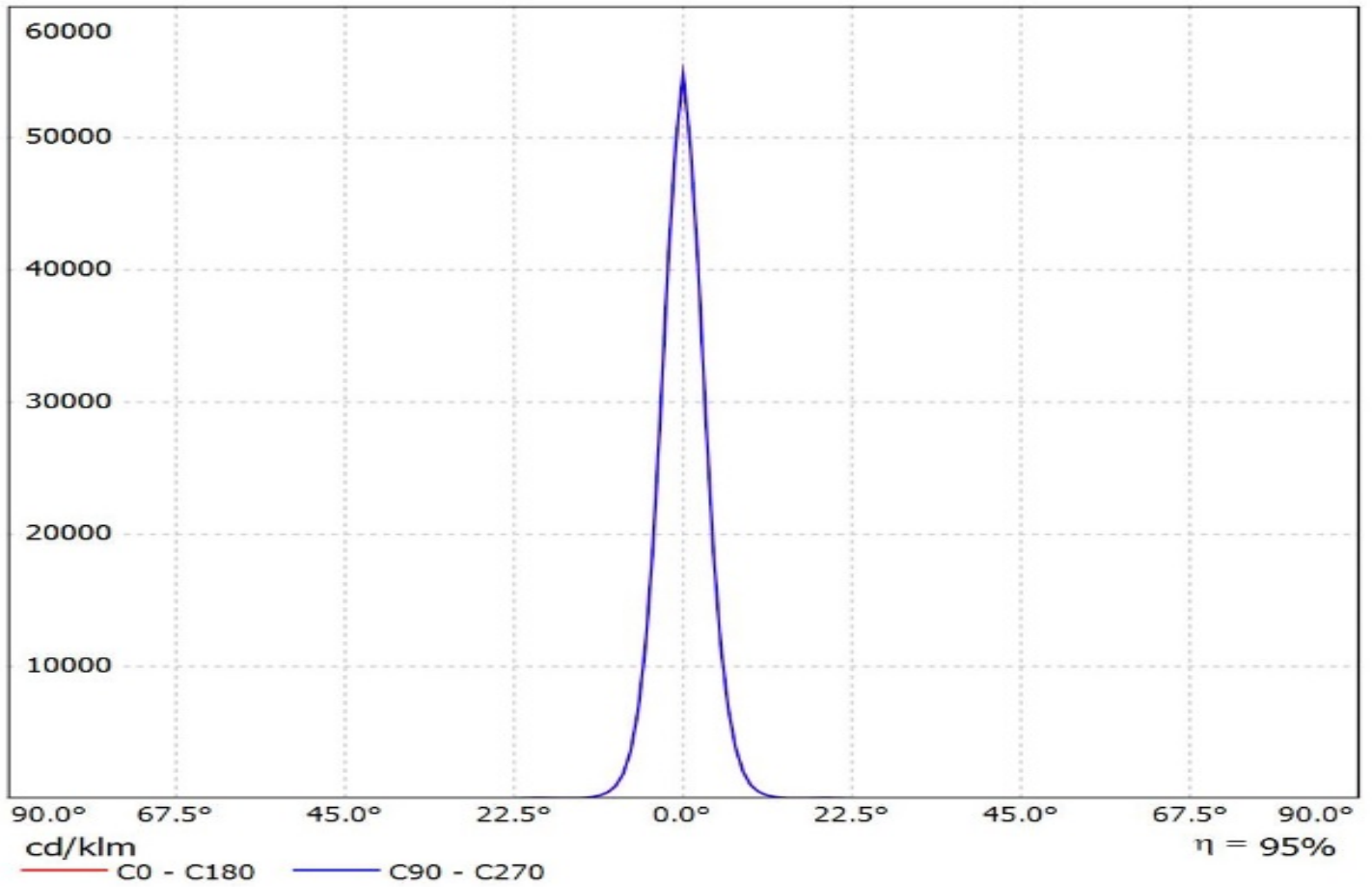

Luminaire: Ledil Oy FCN13552\_CRYSTAL-RS\_(XP-L HI)\_SIMULATED  
Lamps: 1 x Cree XP-L HI

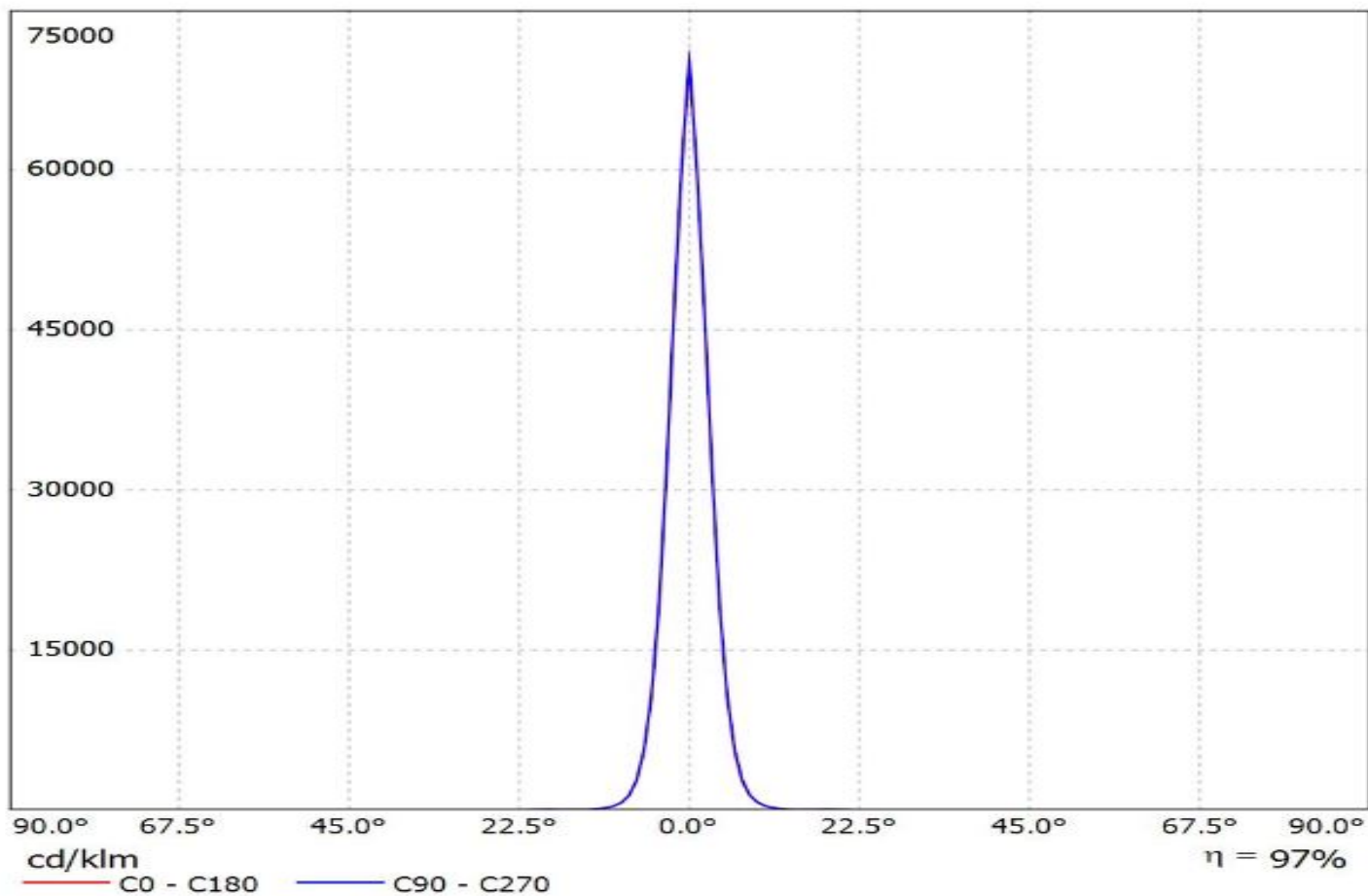

Luminaire: LEDiL Oy CN13552\_CRYSTAL-RS\_(Z\_ES)  
Lamps: 1 x Philips\_Lumileds\_Luxeon\_Z\_ES\_(LXZ2-5070)  
\_84.6528lm@250mA\_P=0.730483W\_I=249.9mA

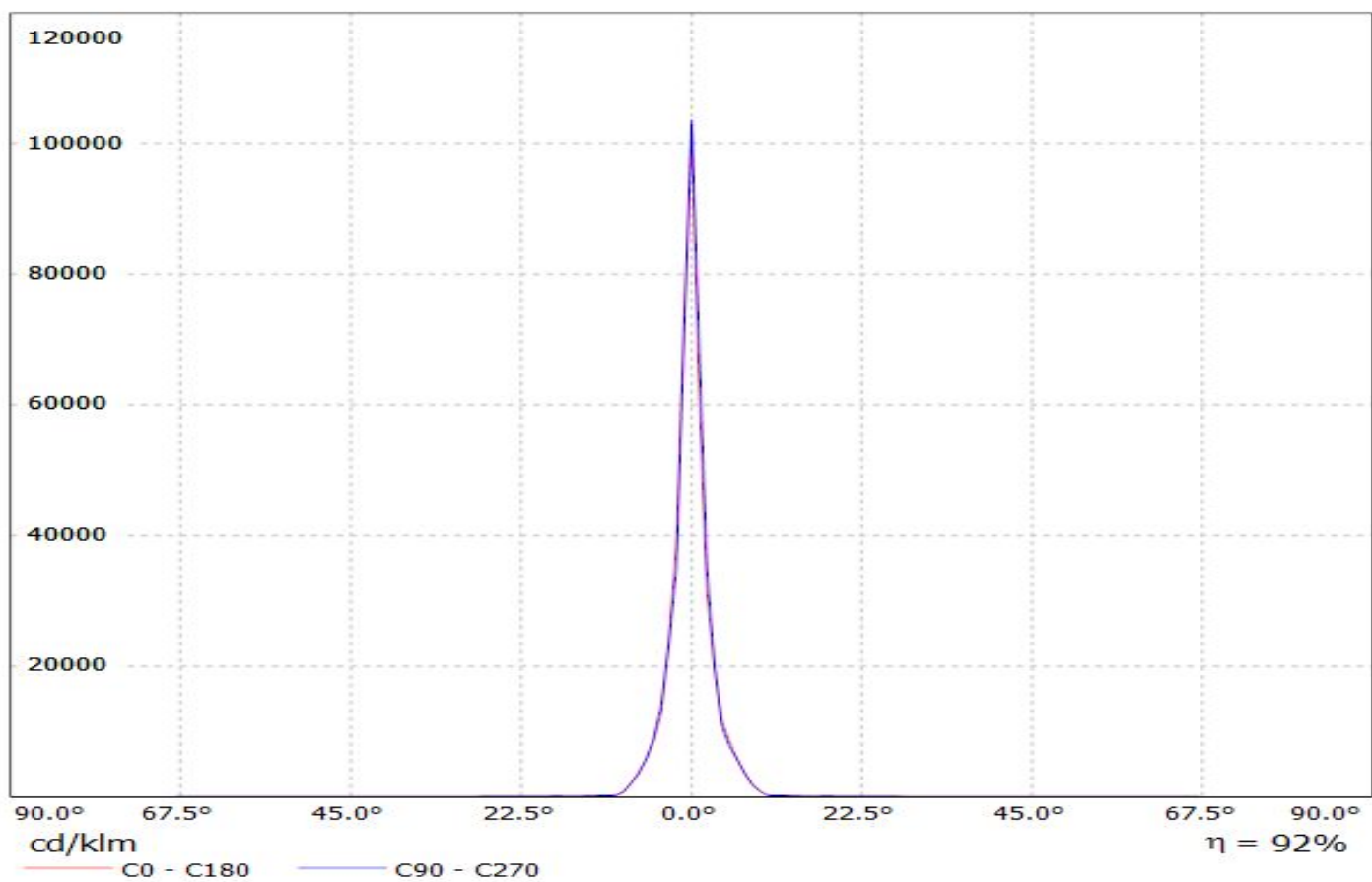

Luminaire: LEDiL Oy FCN13552\_CRYSTAL-RS\_(NWSL229AE)  
Lamps: 1 x Nichia\_NWSL229AE\_120.514lm@250mA\_P=0.7132W\_I=0.250A

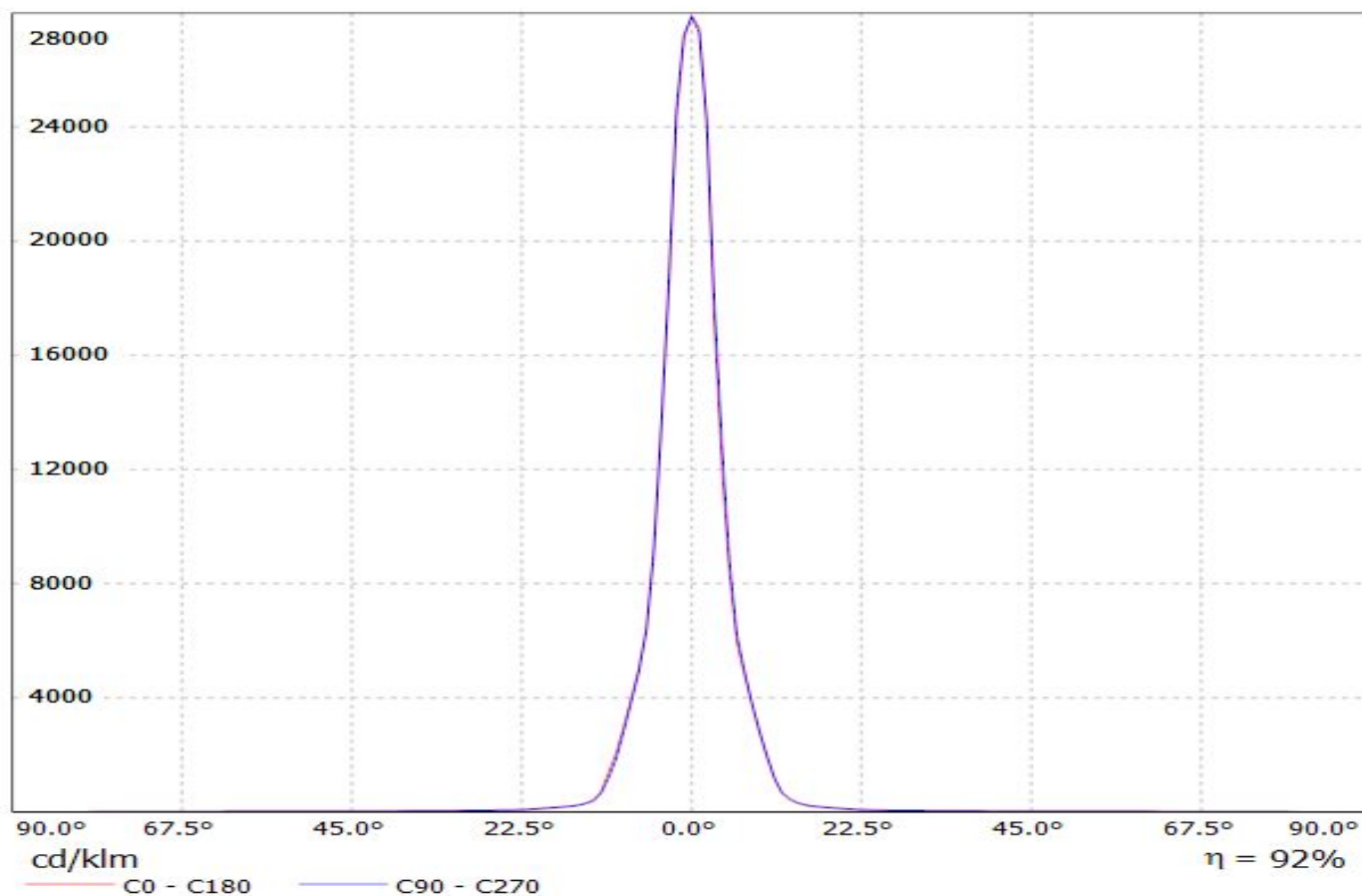

Luminaire: LEDiL Oy FCN13552\_CRYSTAL-RS\_(Nichia\_NV4x144A)  
Lamps: 1 x Nichia\_NV4x144A\_478.709lm@250mA\_P=2.8097W\_I=0.250A

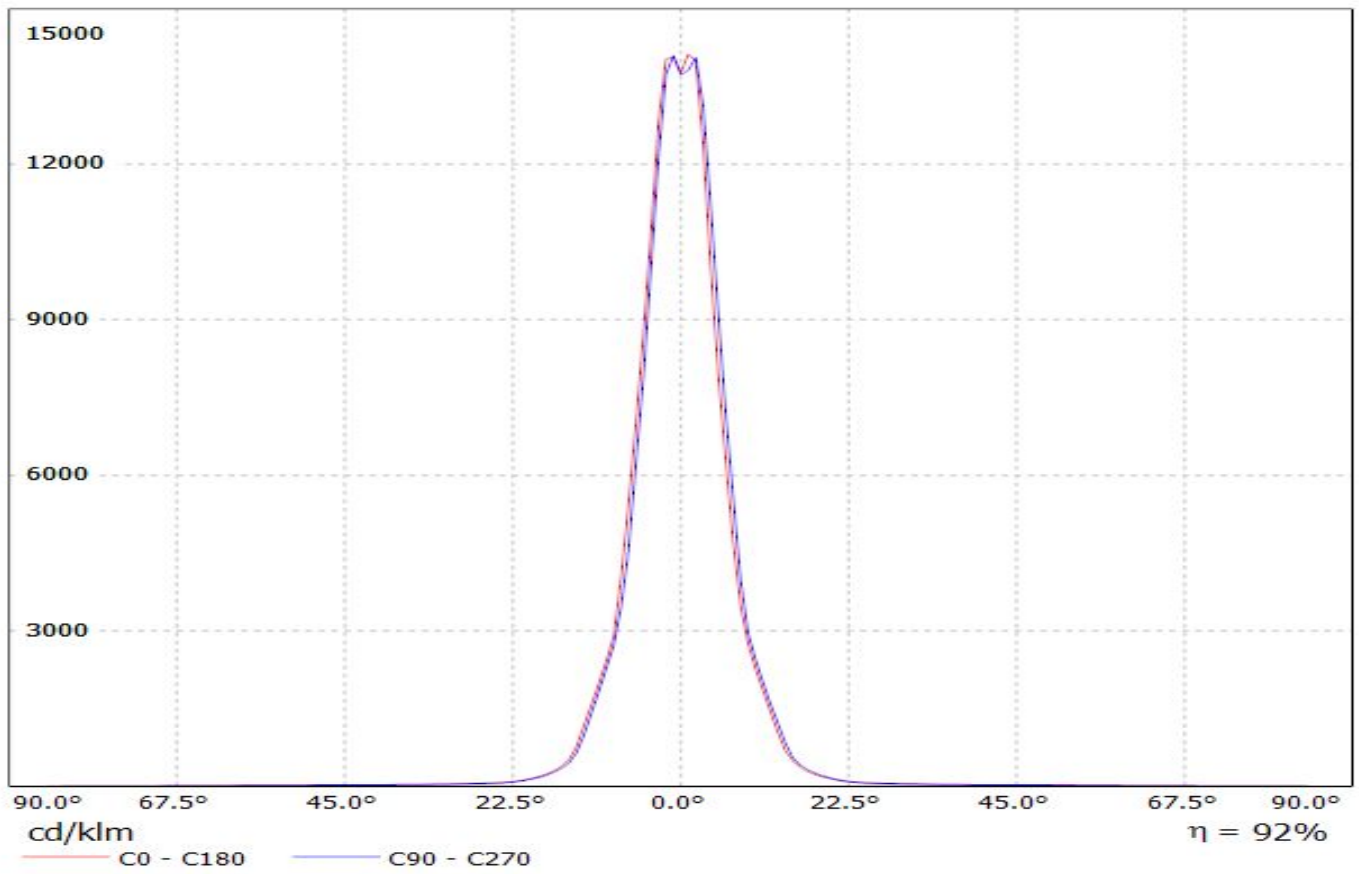

Luminaire: Ledil FCN13552\_CRYSTAL-RS\_(NVSW319AE)

Lamps: 1 x Nichia\_NVSW319AE\_126.239lm@250mA\_P=0.729675W\_I=0.25A

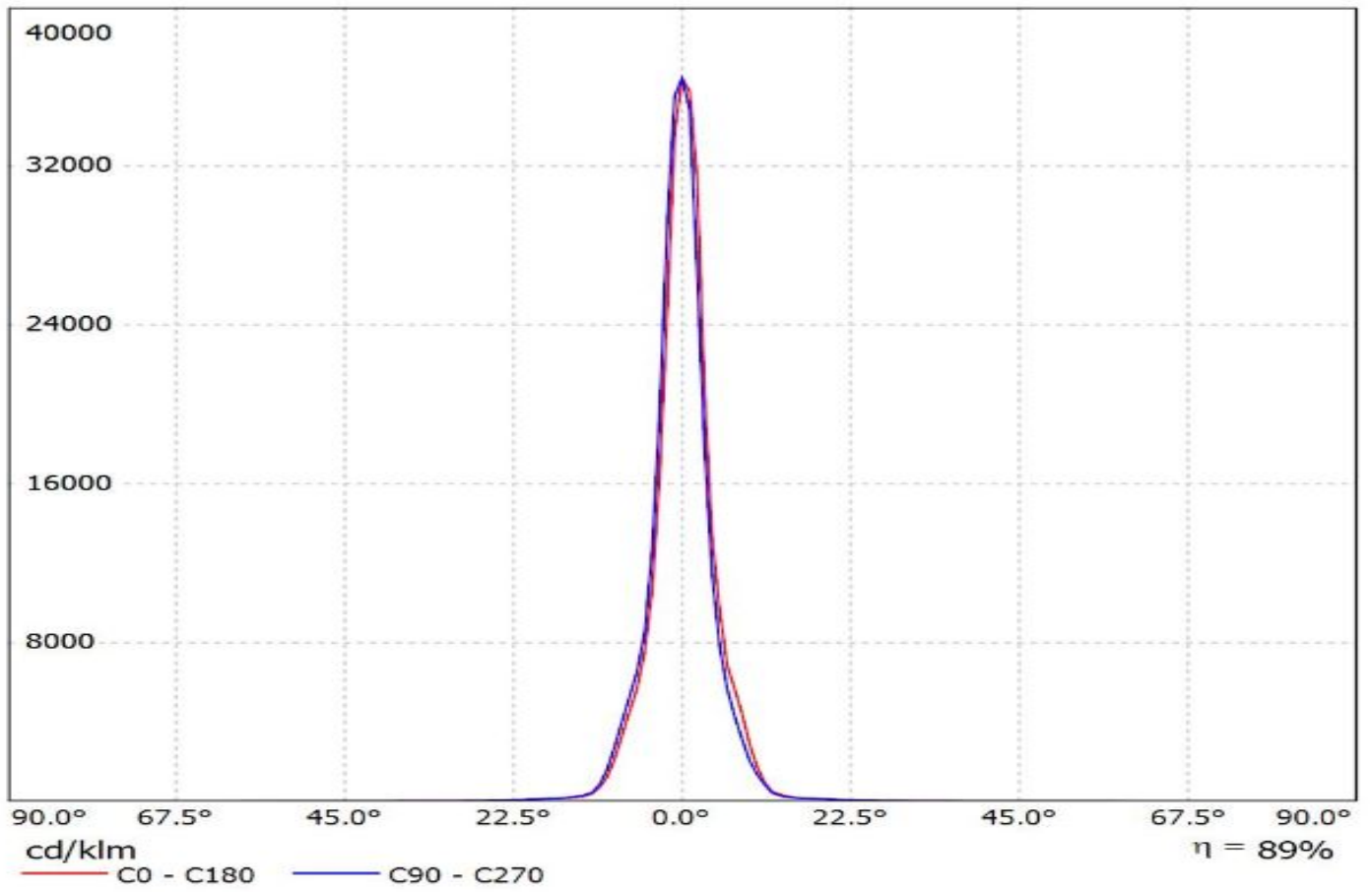

# Ledil CN13552\_CRYSTAL-RS\_(XP-L) / LDC (Polar)

Luminaire: Ledil CN13552\_CRYSTAL-RS\_(XP-L)  
Lamps: 1 x CREE\_XP-L\_(XPLAWT-0-7A3-U50-0H-0001)  
\_107.852lm@250mA\_CCT=3185K\_P=0.7W\_I=0.25A

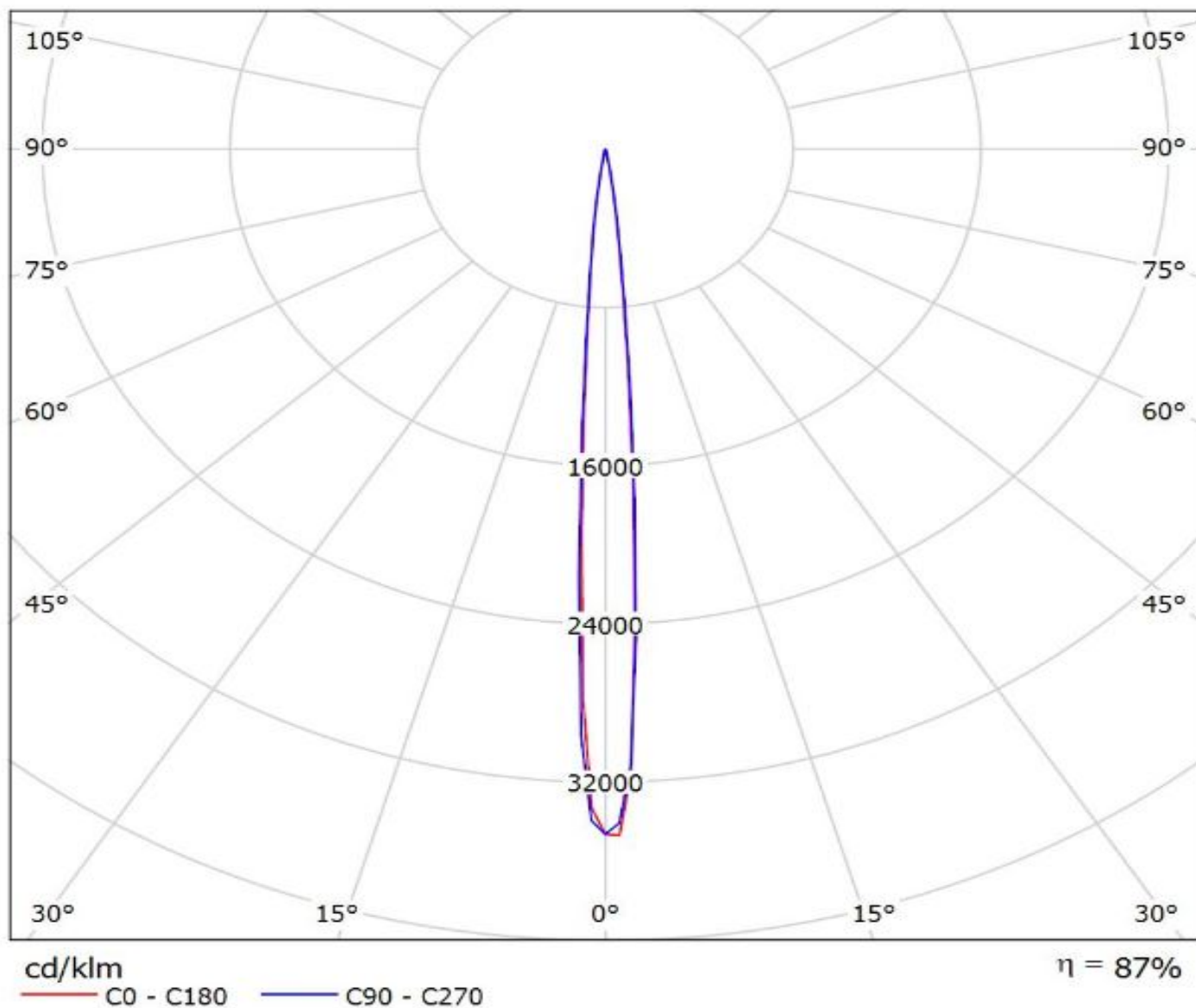



Luminaire: Ledil Oy FCN13552\_CRYSTAL-RS\_SIMULATED

Lamps: 1 x CREE\_XHP35\_HI

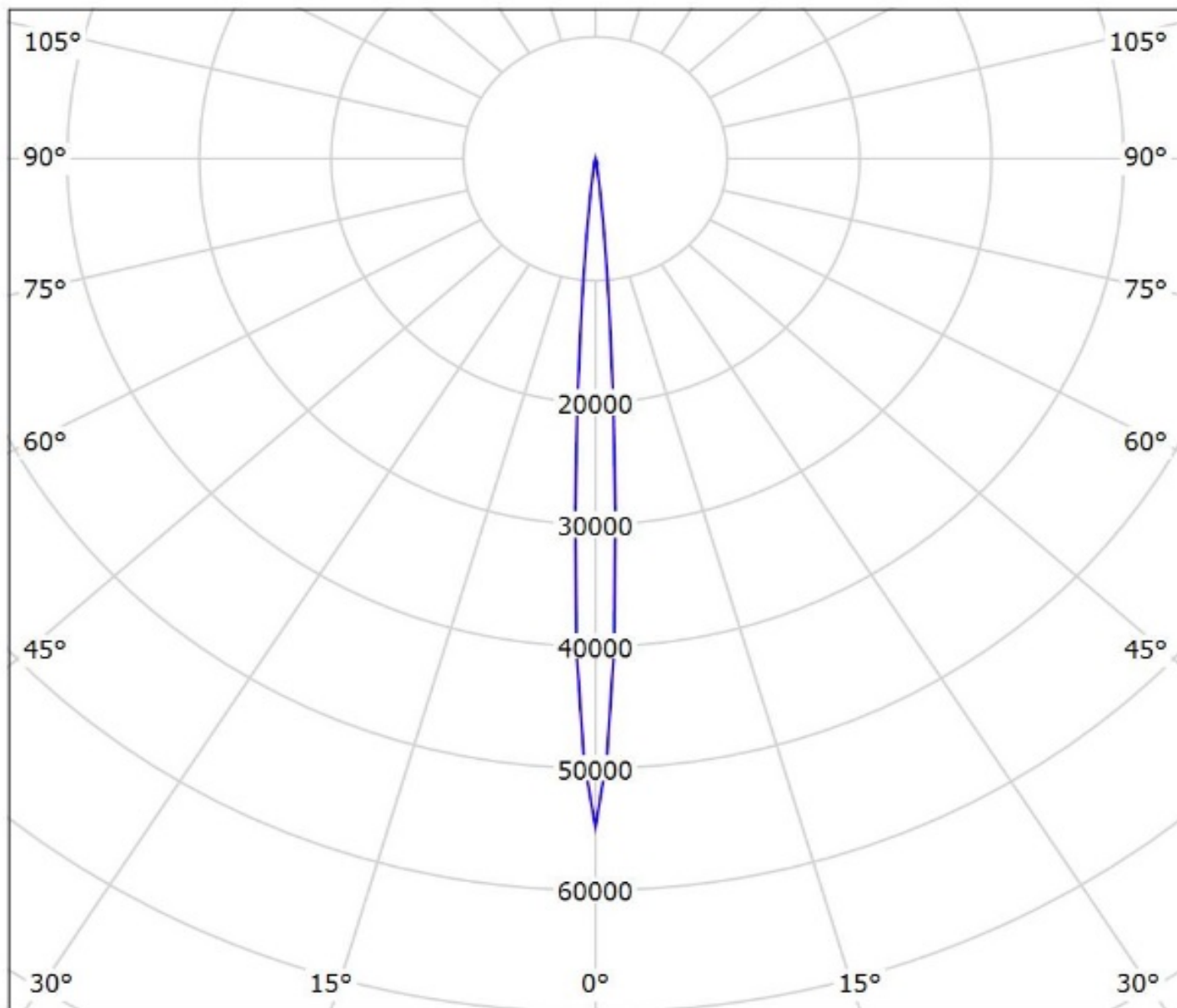

cd/klm

— C0 - C180

— C90 - C270

$\eta = 95\%$

Luminaire: Ledil Oy FCN13552\_CRYSTAL-RS\_(XP-L HI)\_SIMULATED

Lamps: 1 x Cree XP-L HI

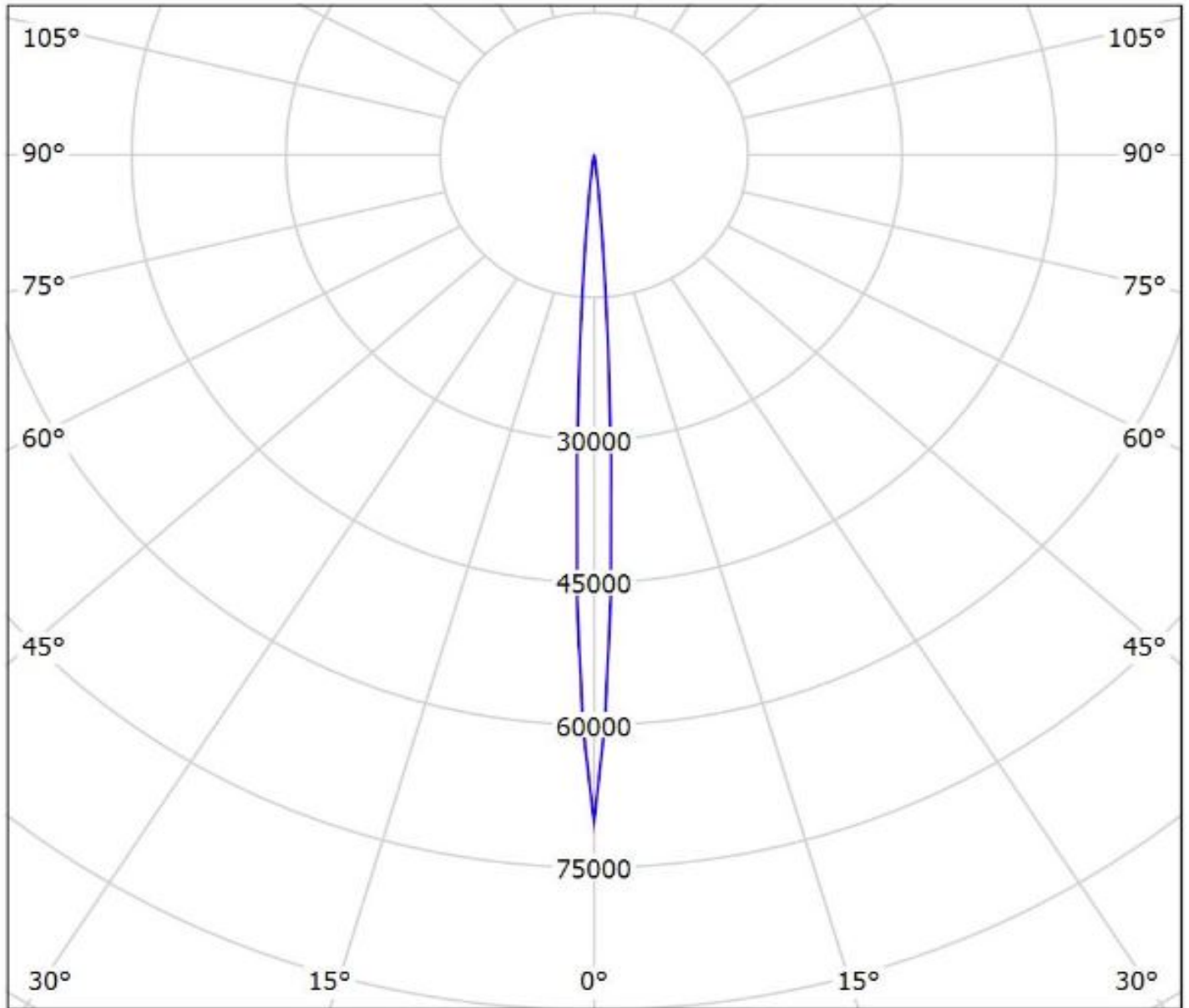

cd/klm

— C0 - C180

— C90 - C270

$\eta = 97\%$

Luminaire: LEDiL Oy CN13552\_CRYSTAL-RS\_(Z\_ES)  
Lamps: 1 x Philips\_Lumileds\_Luxeon\_Z\_ES\_(LXZ2-5070)  
\_84.6528lm@250mA\_P=0.730483W\_I=249.9mA

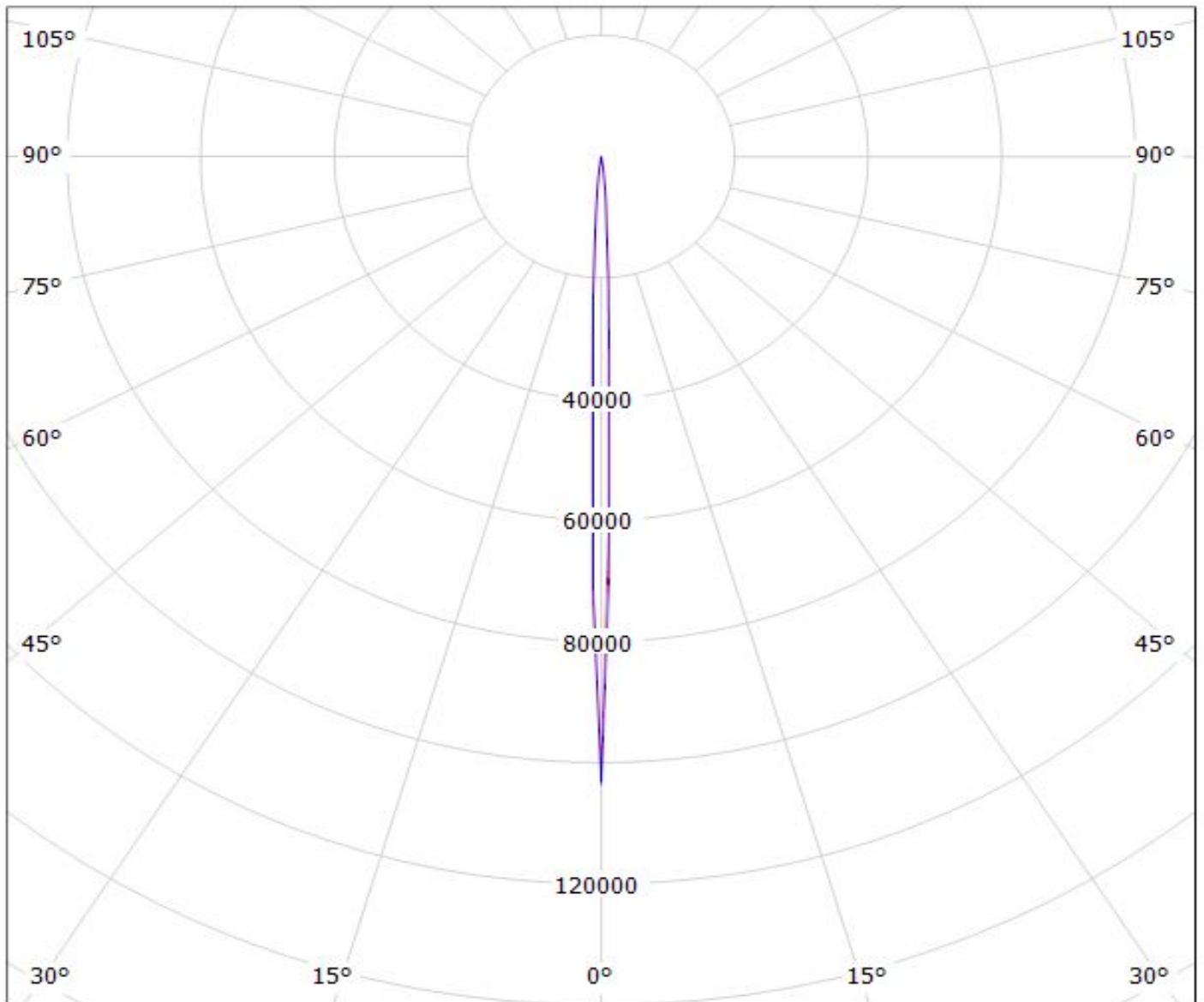

cd/klm

— C0 - C180 — C90 - C270

$\eta = 92\%$

Luminaire: LEDiL Oy FCN13552\_CRYSTAL-RS\_(NWSL229AE)

Lamps: 1 x Nichia\_NWSL229AE\_120.514lm@250mA\_P=0.7132W\_I=0.250A

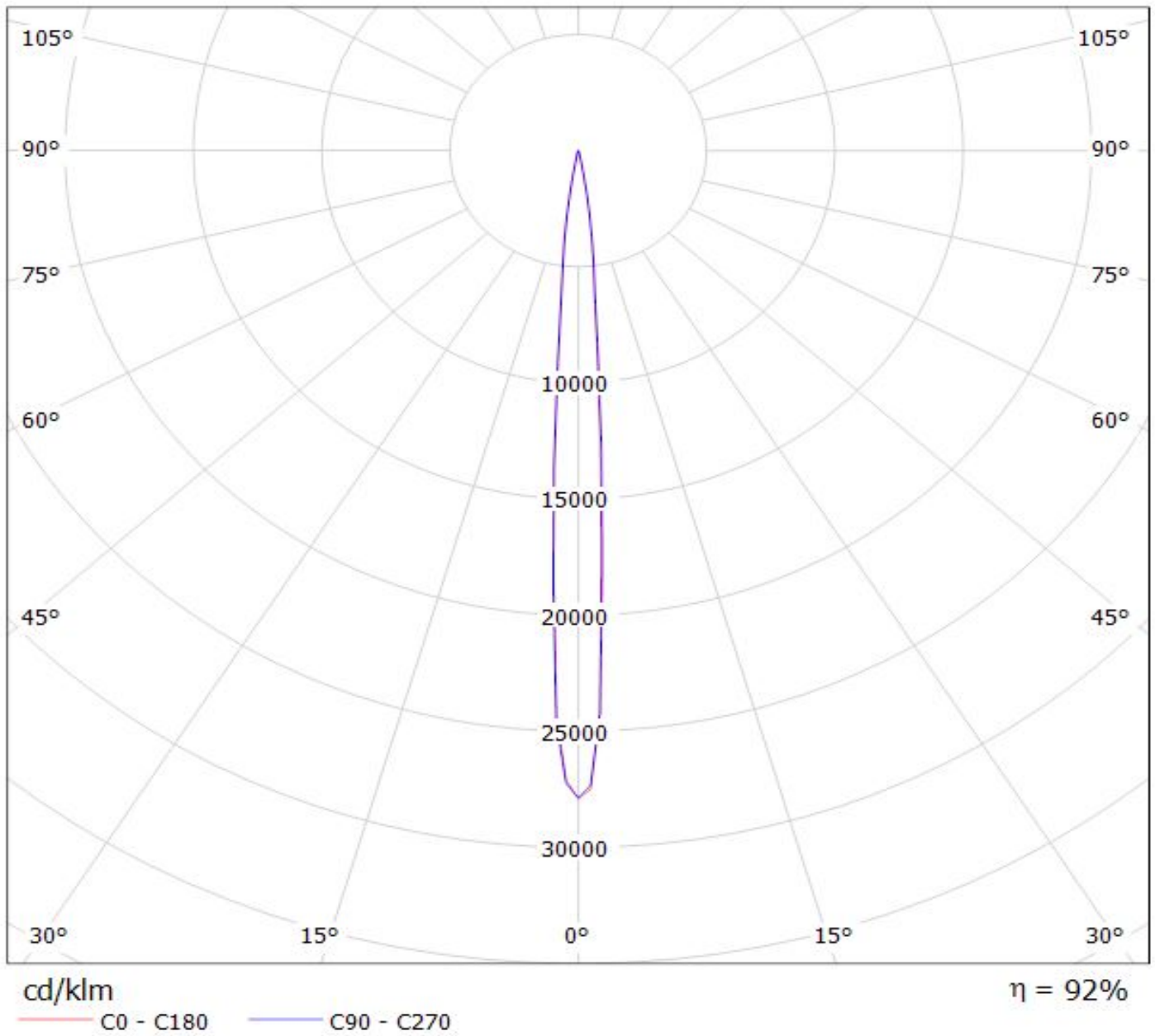

Luminaire: LEDiL Oy FCN13552\_CRYSTAL-RS\_(Nichia\_NV4x144A)  
Lamps: 1 x Nichia\_NV4x144A\_478.709lm@250mA\_P=2.8097W\_I=0.250A

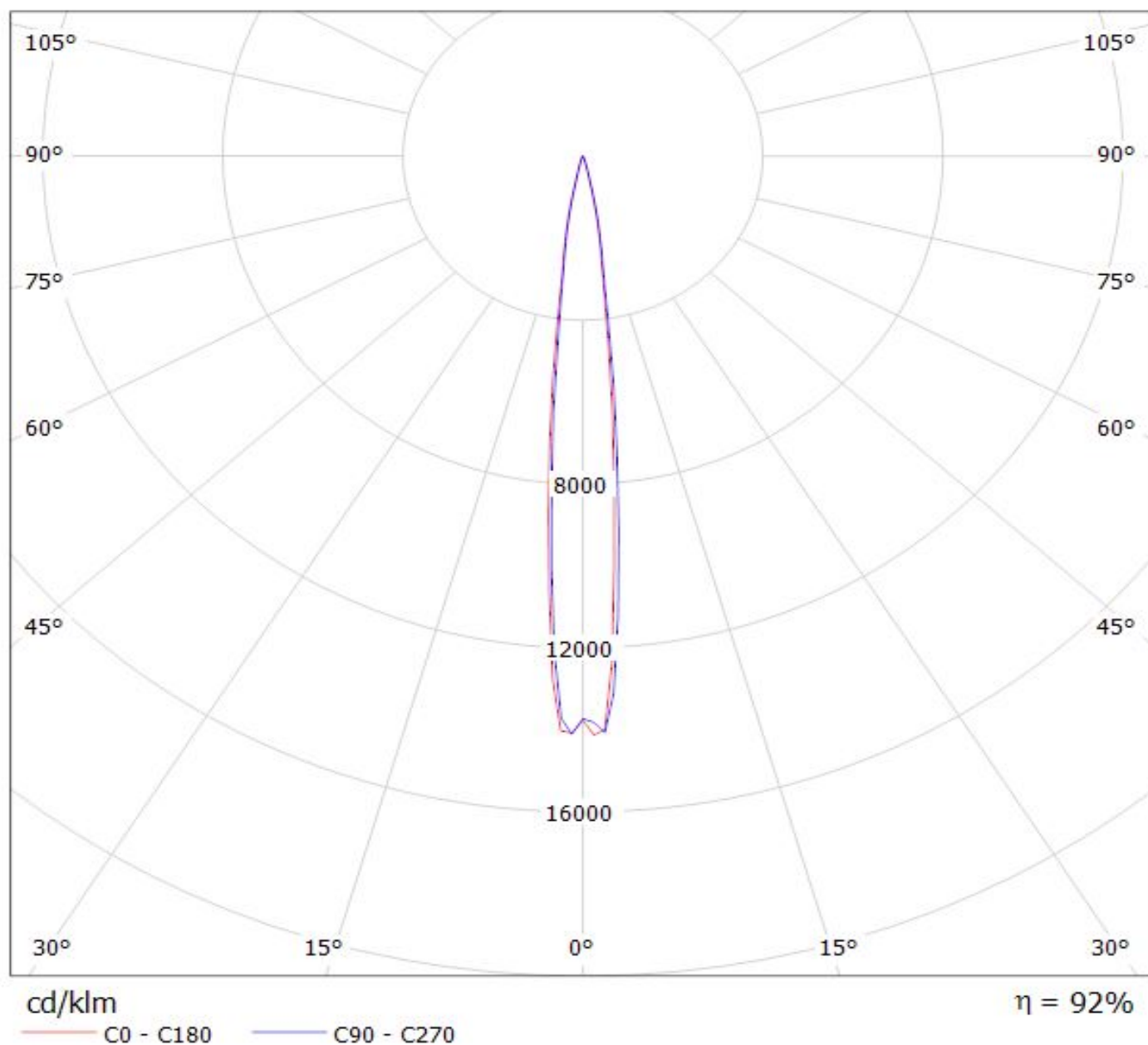

Luminaire: Ledil FCN13552\_CRYSTAL-RS\_(NVSW319AE)

Lamps: 1 x Nichia\_NVSW319AE\_126.239lm@250mA\_P=0.729675W\_I=0.25A

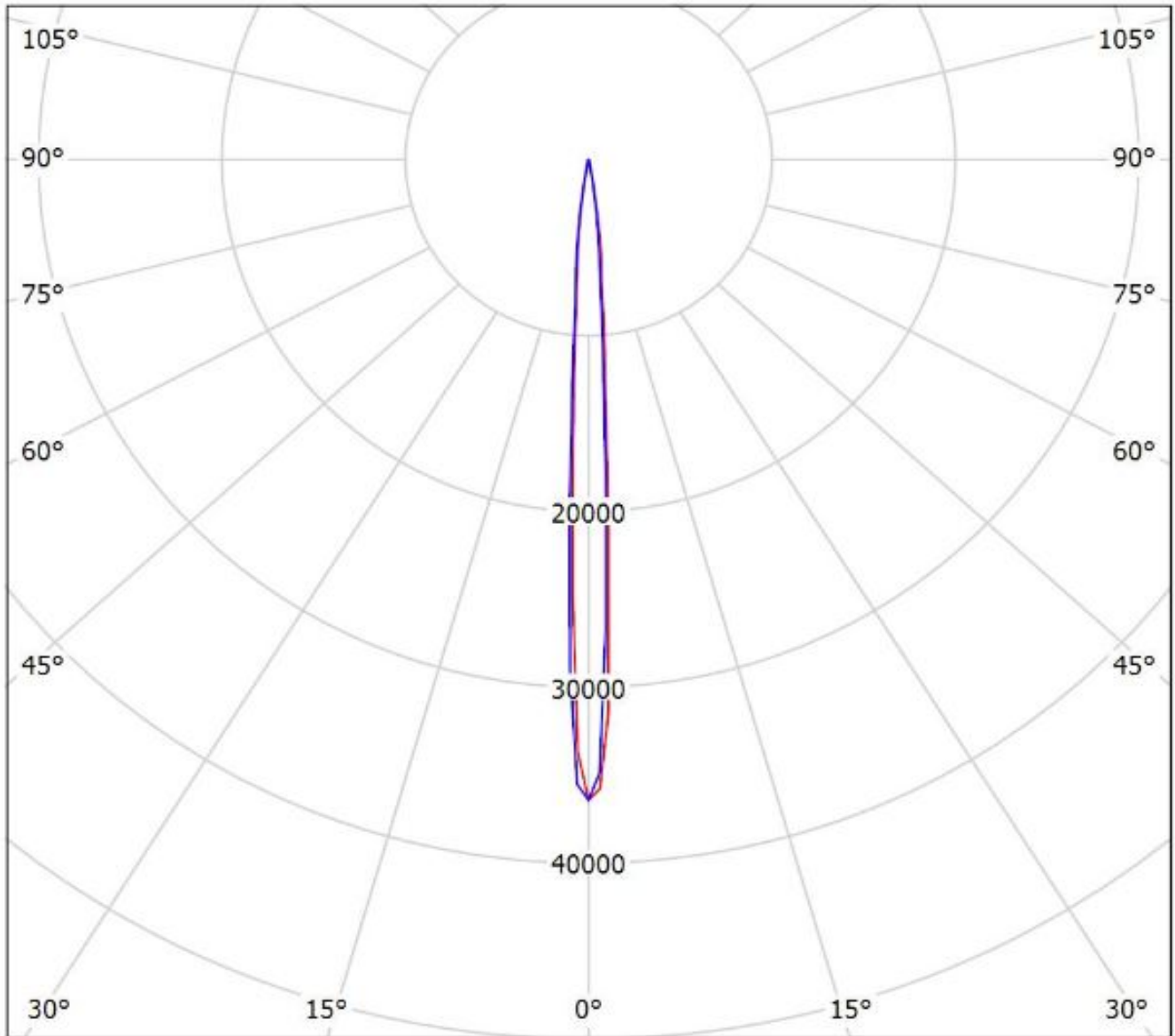

cd/klm

— C0 - C180 — C90 - C270

$\eta = 89\%$

**NOTE: The typical divergence will be changed by different color, chip size and chip position tolerance. The typical total divergence is the full angle measured where the luminous intensity is half of the peak value.**