

## CW025 Dual Output-Series Power Modules: 36 Vdc to 75 Vdc Input; 25 W



The CW025 Dual Output-Series Power Modules use advanced, surface-mount technology and deliver high-quality, compact, dc-dc conversion at an economical price.

### Features

- Small size: 71.1 mm x 61.0 mm x 12.7 mm (2.80 in. x 2.40 in. x 0.50 in.)
- Low output noise
- Industry-standard pinout
- Metal case
- 2:1 input voltage range
- Remote on/off (positive logic)
- *UL*\* Recognized, *CSA*† Certified, and VDE Licensed
- Within FCC and CISPR Class A Radiated Limits
- CE mark meets 73/23/EEC and 93/68/EEC directives‡
- Two tightly regulated outputs

### Applications

- Distributed power architectures
- Telecommunications

### Options

- Isolated case pin
- Higher accuracy output voltage clamp set point
- Short pin: 2.79 mm ± 0.25 mm (0.110 in. ± 0.010 in.)
- Heat sink available for extended operation
- Negative logic remote on/off

### Description

The CW025 Dual Output-Series Power Modules are a family of dc-dc converters that operate over an input voltage range of 36 Vdc to 75 Vdc and provide two regulated outputs. These modules offer low noise levels with industry-standard pinouts in a small footprint. Each highly reliable and efficient unit features remote on/off and current limit.

Each output is individually regulated by its own control circuit and has an independent overvoltage clamp. With standard outputs of ±5 V, ±12 V, and ±15 V, the CW025 Dual Output-Series is flexible enough to provide modified standard units with any combination of output voltages from 2 V to 15 V.

Efficiency greater than 80%, a wide operating temperature range, and a metal case are additional features of these modules.

\* *UL* is a registered trademark of Underwriters Laboratories, Inc.  
† *CSA* is a registered trademark of Canadian Standards Association.

‡ This product is intended for integration into end-use equipment. All the required procedures for CE marking of end-use equipment should be followed. (The CE mark is placed on selected products.)

## Absolute Maximum Ratings

Stresses in excess of the absolute maximum ratings can cause permanent damage to the device. These are absolute stress ratings only. Functional operation of the device is not implied at these or any other conditions in excess of those given in the operational sections of the data sheet. Exposure to absolute maximum ratings for extended periods can adversely affect device reliability.

Parameter	Symbol	Min	Max	Unit
Input Voltage				
Continuous	$V_I$	—	80	Vdc
Transient (10 ms)	$V_{I, trans}$	—	100	V
I/O Isolation Voltage				
dc	—	—	500	V
Transient (1 minute)	—	—	850	V
Operating Case Temperature	$T_C$	-40	100	°C
Storage Temperature	$T_{stg}$	-55	125	°C

## Electrical Specifications

Unless otherwise indicated, specifications apply over all operating input voltage, resistive load, and temperature conditions.

**Table 1. Input Specifications**

Parameter	Symbol	Min	Typ	Max	Unit
Operating Input Voltage	$V_I$	36	48	75	Vdc
Maximum Input Current ( $V_I = 0$ V to 75 V; $I_O = I_{O, max}$ ; see Figure 1.)	$I_{I, max}$	—	—	2.0	A
Inrush Transient	$i^2t$	—	—	0.8	A <sup>2</sup> s
Input Reflected-ripple Current, Peak-to-peak (5 Hz to 20 MHz, 12 $\mu$ H source impedance; $T_C = 25$ °C; see Figure 11 and Design Considerations section.)	—	—	25	—	mAp-p
Input Ripple Rejection (120 Hz)	—	—	60	—	dB

## Fusing Considerations

**CAUTION: This power module is not internally fused. An input line fuse must always be used.**

This encapsulated power module can be used in a wide variety of applications, ranging from simple stand-alone operation to an integrated part of a sophisticated power architecture. To preserve maximum flexibility, internal fusing is not included; however, to achieve maximum safety and system protection, always use an input line fuse. The safety agencies require a normal-blow, dc fuse with a maximum rating of 5 A (see Safety Considerations section). Based on the information provided in this data sheet on inrush energy and maximum dc input current, the same type of fuse with a lower rating can be used. Refer to the fuse manufacturer's data for further information.

**Electrical Specifications** (continued)

**Table 2. Output Specifications**

Parameter	Device	Symbol	Min	Typ	Max	Unit
Output Voltage (Over all operating input voltage, resistive load, and temperature conditions until end of life. See Figure 11.)	CW025AJ-M	V <sub>O1</sub>	4.80	—	5.25	Vdc
		V <sub>O2</sub>	-4.80	—	-5.25	Vdc
	CW025BK-M	V <sub>O1</sub>	11.40	—	12.60	Vdc
		V <sub>O2</sub>	-11.40	—	-12.60	Vdc
	CW025CL-M	V <sub>O1</sub>	14.25	—	15.75	Vdc
		V <sub>O2</sub>	-14.25	—	-15.75	Vdc
Output Voltage Set Point (V <sub>I</sub> = 48 V; I <sub>o</sub> = I <sub>o, max</sub> ; T <sub>C</sub> = 25 °C)	CW025AJ-M	V <sub>O1, set</sub>	4.90	5.0	5.10	Vdc
		V <sub>O2, set</sub>	-4.90	-5.0	-5.10	Vdc
	CW025BK-M	V <sub>O1, set</sub>	11.76	12.0	12.24	Vdc
		V <sub>O2, set</sub>	-11.76	-12.0	-12.24	Vdc
	CW025CL-M	V <sub>O1, set</sub>	14.70	15.0	15.30	Vdc
		V <sub>O2, set</sub>	-14.70	-15.0	-15.30	Vdc
Output Regulation: Line (V <sub>I</sub> = 36 V to 75 V) Load (I <sub>o1</sub> = I <sub>o, min</sub> to I <sub>o, max</sub> , I <sub>o2</sub> = I <sub>o, max</sub> ) Load (I <sub>o2</sub> = I <sub>o, min</sub> to I <sub>o, max</sub> , I <sub>o1</sub> = I <sub>o, max</sub> ) Temperature (T <sub>C</sub> = -40 °C to +100 °C)	All	—	—	0.1	0.2	%
	All	—	—	0.1	0.4	%
	All	—	—	0.1	0.4	%
	CW025AJ-M	—	—	15	70	mV
	CW025BK-M	—	—	40	150	mV
	CW025CL-M	—	—	40	190	mV
Output Ripple and Noise (See Figure 12.): RMS  Peak-to-peak (5 Hz to 20 MHz)	CW025AJ-M	—	—	—	15	mV <sub>rms</sub>
		—	—	—	20	s
	CW025BK-M	—	—	—	25	mV <sub>rms</sub>
		—	—	—	150	s
	CW025CL-M	—	—	—	200	mV <sub>rms</sub>
		—	—	—	250	s
	CW025AJ-M	—	—	—	—	mV <sub>p-p</sub>
		—	—	—	—	mV <sub>p-p</sub>
	CW025BK-M	—	—	—	—	mV <sub>p-p</sub>
		—	—	—	—	mV <sub>p-p</sub>
Output Current (At I <sub>o</sub> < I <sub>o, min</sub> , the modules may exceed output ripple specifications.)	CW025AJ-M	I <sub>o1</sub>	0.20	—	2.50	A
		I <sub>o2</sub>	0.20	—	2.50	A
	CW025BK-M	I <sub>o1</sub>	0.10	—	1.04	A
		I <sub>o2</sub>	0.10	—	1.04	A
	CW025CL-M	I <sub>o1</sub>	0.08	—	0.83	A
		I <sub>o2</sub>	0.08	—	0.83	A
Output Current-limit Inception (V <sub>o</sub> = 90% of V <sub>o, nom</sub> ; see Figure 2.)	CW025AJ-M	—	—	3.7	6.5	A
	CW025BK-M	—	—	1.5	2.9	A
	CW025CL-M	—	—	1.3	2.7	A
Output Short-circuit Current (V <sub>o</sub> = 250 mV)	CW025AJ-M	—	—	3.5	7.0	A
	CW025BK-M	—	—	1.0	3.0	A
	CW025CL-M	—	—	1.0	3.0	A
Efficiency (V <sub>I</sub> = 48 V; I <sub>o</sub> = I <sub>o, max</sub> ; T <sub>C</sub> = 25 °C; see Figures 3 and 11.)	CW025AJ-M	η	75	78	—	%
	CW025BK-M	η	79	82	—	%
	CW025CL-M	η	79	82	—	%

## Electrical Specifications (continued)

**Table 2. Output Specifications (continued)**

Parameter	Device	Symbol	Min	Typ	Max	Unit
Dynamic Response ( $\dot{I}_o/\dot{I}_t = 1 \text{ A}/10 \mu\text{s}$ , $V_i = 48 \text{ V}$ , $T_c = 25 \text{ }^\circ\text{C}$ ): Load Change from $I_o = 50\%$ to $75\%$ of $I_{o, \text{max}}$ (See Figures 7 to 9.): Peak Deviation  Settling Time ( $V_o < 10\%$ peak deviation) Load Change from $I_o = 50\%$ to $25\%$ of $I_{o, \text{max}}$ (See Figures 4 to 6.): Peak Deviation  Settling Time ( $V_o < 10\%$ peak deviation)	CW025AJ-M	—	—	160	—	mV
	CW025BK-M	—	—	250	—	mV
	CW025CL-M	—	—	250	—	mV
	All	—	—	3	—	ms
	CW025AJ-M	—	—	160	—	mV
	CW025BK-M	—	—	250	—	mV
	CW025CL-M	—	—	250	—	mV
	All	—	—	0.5	—	ms

**Table 3. Isolation Specifications**

Parameter	Min	Typ	Max	Unit
Isolation Capacitance	—	1200	—	pF
Isolation Resistance	10	—	—	M <sup>3</sup> / <sub>4</sub>

## General Specifications

Parameter	Min	Typ	Max	Unit
Calculated MTBF ( $I_o = 80\%$ of $I_{o, \text{max}}$ ; $T_c = 40 \text{ }^\circ\text{C}$ )	2,800,000			hours
Weight	—	—	113 (4.0)	g (oz.)

## Feature Specifications

Unless otherwise indicated, specifications apply over all operating input voltage, resistive load, and temperature conditions. See Feature Descriptions and Design Considerations for further information.

Parameter	Device	Symbol	Min	Typ	Max	Unit
Remote On/Off ( $V_i = 0\text{ V}$ to $75\text{ V}$ ; open collector or equivalent compatible; signal referenced to $V_i(-)$ terminal. See Figures 10 and 14 and Feature Descriptions.):						
CW025xx-M Positive Logic:						
Logic Low—Module Off						
Logic High—Module On						
CW025xx1-M Negative Logic:						
Logic Low—Module On						
Logic High—Module Off						
Module Specifications:						
On/Off Current—Logic Low	All	$I_{on/off}$	—	—	1.0	mA
On/Off Voltage:						
Logic Low	All	$V_{on/off}$	0	—	1.2	V
Logic High ( $I_{on/off} = 0$ )	All	$V_{on/off}$	—	—	10	V
Open Collector Switch Specifications:						
Leakage Current During Logic High ( $V_{on/off} = 10\text{ V}$ )	All	$I_{on/off}$	—	—	50	$\mu\text{A}$
Output Low Voltage During Logic Low ( $I_{on/off} = 1\text{ mA}$ )	All	$V_{on/off}$	—	—	1.2	V
Turn-on Time ( $I_o = 80\%$ of $I_{o, max}$ ; $V_o$ within $\pm 1\%$ of steady state)	All	—	—	30	—	ms
Output Voltage Overshoot	All	—	—	0	5	%
Output Overvoltage Clamp	CW025AJ	$V_{O1}$	—	—	7	V
		$V_{O2}$	—	—	-7	V
	CW025BK	$V_{O1}$	—	—	16	V
		$V_{O2}$	—	—	-16	V
	CW025CL	$V_{O1}$	—	—	20	V
		$V_{O2}$	—	—	-20	V
Input Undervoltage Lockout:						
Module On	All	$V_{UVLO}$	—	28	36	V
Module Off	All	$V_{UVLO}$	20	28	—	V

Characteristic Curves

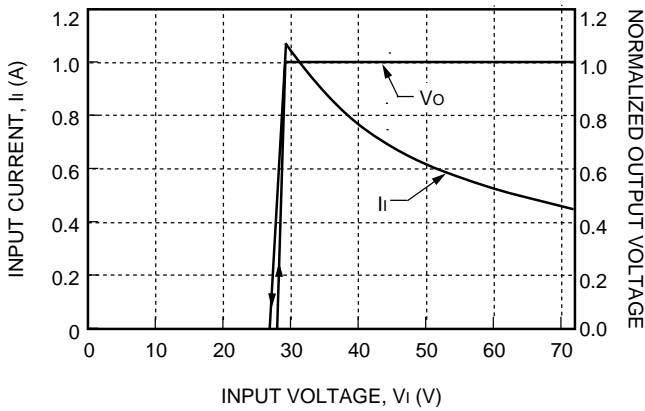

8-993(C).b

Figure 1. CW025 Dual Output-Series Input Current and Normalized Output Voltage vs. Input Voltage at Full Load and  $T_c = 25\text{ }^\circ\text{C}$

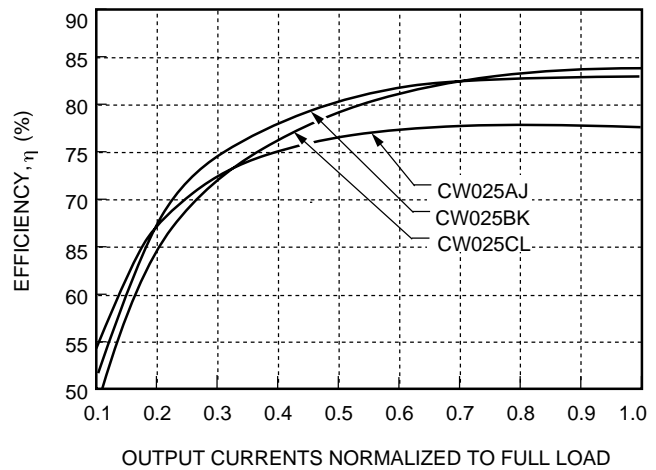

8-1021(C)

Figure 3. CW025 Dual Output-Series Efficiency vs. Normalized Output Currents (Equal Load on Both Outputs) at  $V_i = 48\text{ V}$  and  $T_c = 25\text{ }^\circ\text{C}$

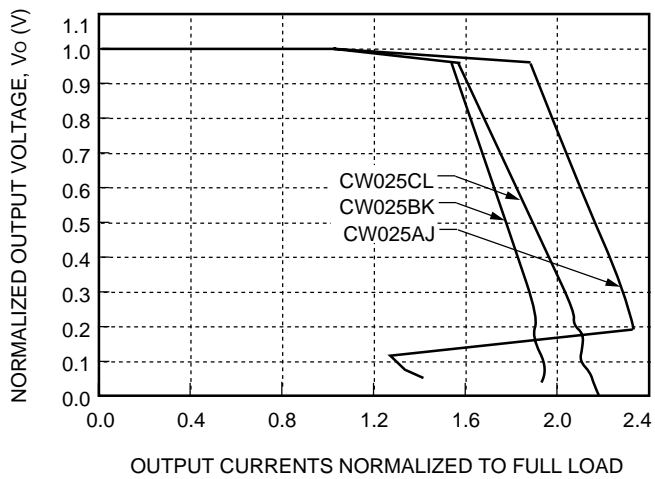

8-1022(C)

Figure 2. CW025 Dual Output-Series Normalized Output Current vs. Normalized Output Voltage at  $V_i = 48\text{ V}$  and  $T_c = 25\text{ }^\circ\text{C}$

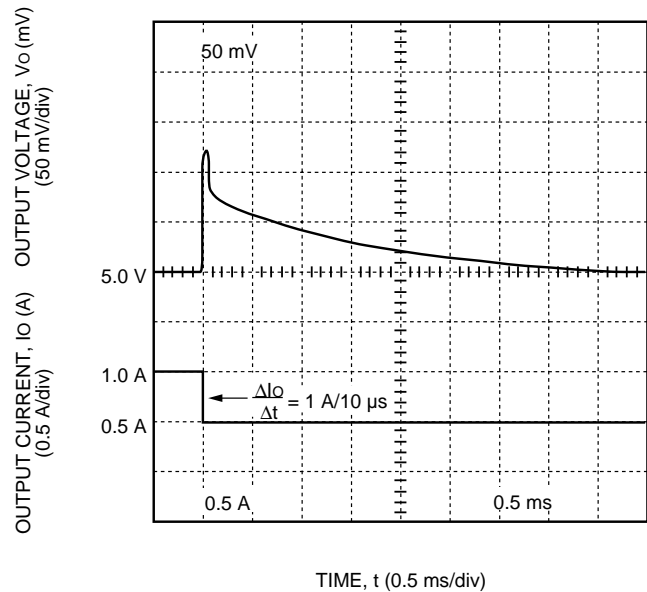

8-1019(C)

Figure 4. CW025 Dual Output-Series Typical 5 V Output Voltage Response to a Step Load Change from 50% to 25% of  $I_{o,max}$  at  $V_i = V_{i,nom}$  and  $T_c = 25\text{ }^\circ\text{C}$

Characteristic Curves (continued)

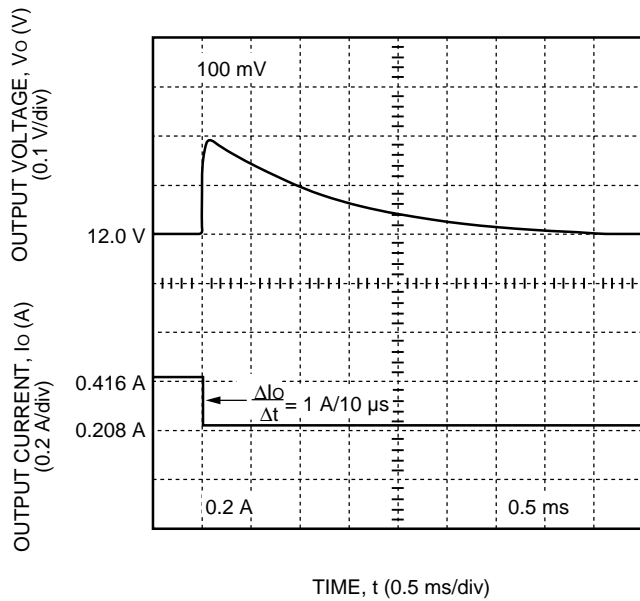

Figure 5. CW025 Dual Output-Series Typical 12 V Output Voltage Response to a Step Load Change from 50% to 25% of  $I_{o,max}$  at  $V_i = V_{i,nom}$  and  $T_c = 25\text{ }^\circ\text{C}$

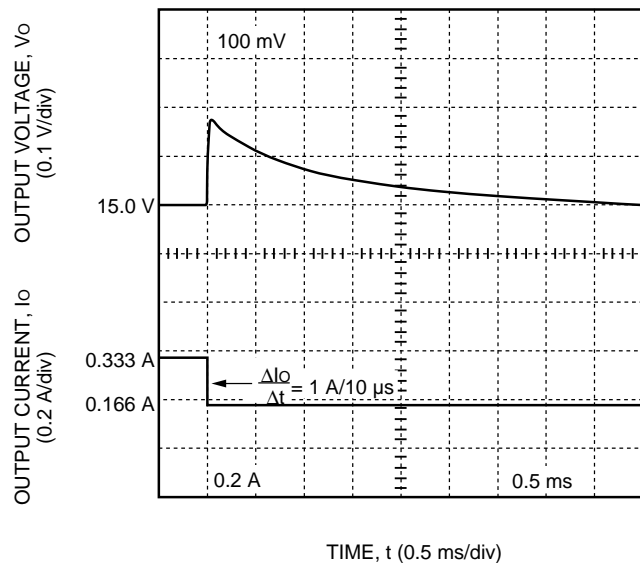

Figure 6. CW025 Dual Output-Series Typical 15 V Output Voltage Response to a Step Load Change from 50% to 75% of  $I_{o,max}$  at  $V_i = V_{i,nom}$  and  $T_c = 25\text{ }^\circ\text{C}$

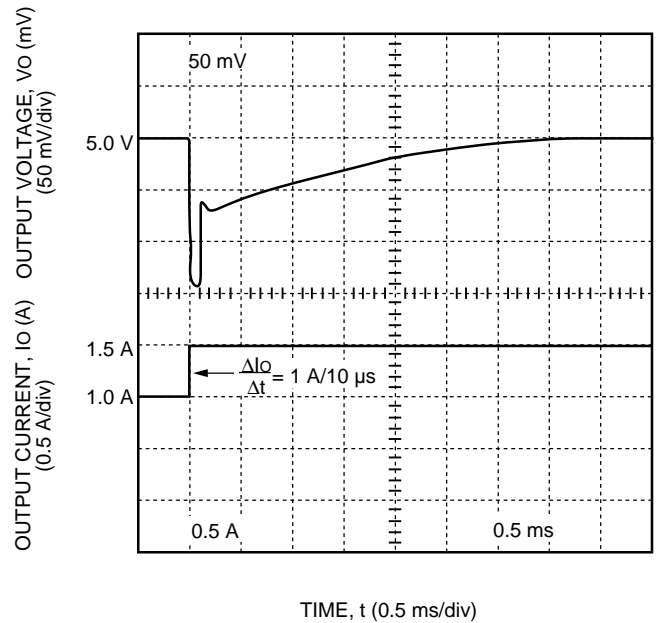

Figure 7. CW025 Dual Output-Series Typical 5 V Output Voltage Response to a Step Load Change from 50% to 75% of  $I_{o,max}$  at  $V_i = V_{i,nom}$  and  $T_c = 25\text{ }^\circ\text{C}$

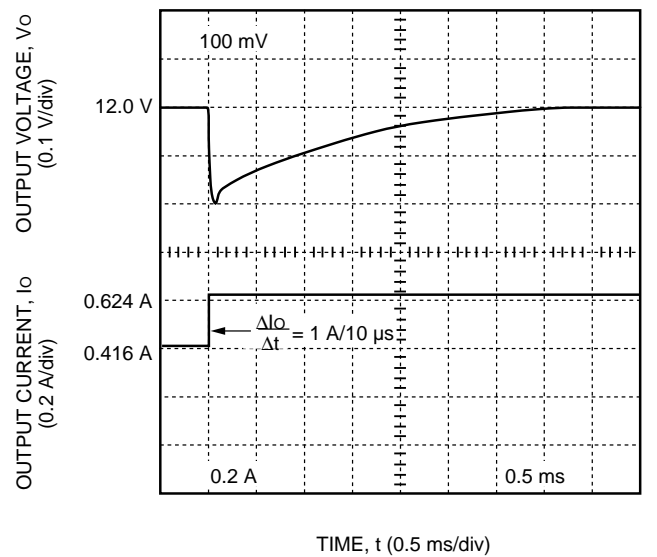
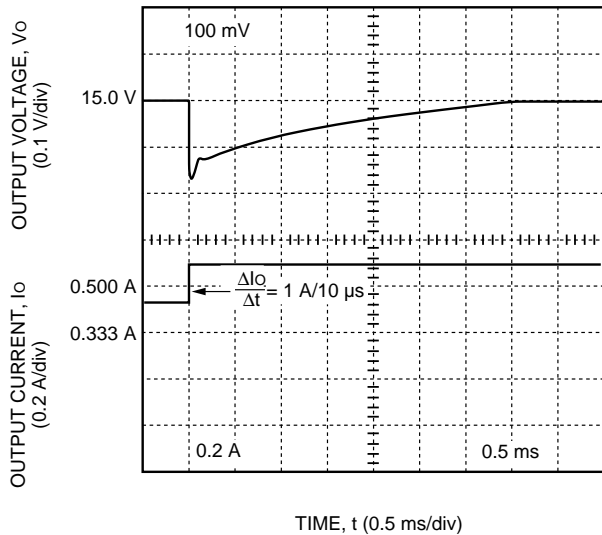

Figure 8. CW025 Dual Output-Series Typical 12 V Output Voltage Response to a Step Load Change from 50% to 75% of  $I_{o,max}$  at  $V_i = V_{i,nom}$  and  $T_c = 25\text{ }^\circ\text{C}$

Characteristic Curves (continued)



8-526(C)

Figure 9. CW025 Dual Output-Series Typical 15 V Output Voltage Response to a Step Load Change from 50% to 75% of  $I_{o, max}$  at  $V_i = V_{i, nom}$  and  $T_c = 25\text{ }^\circ\text{C}$

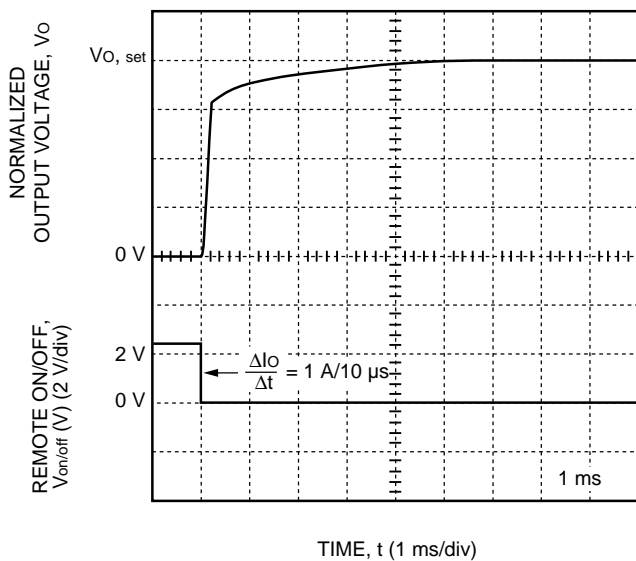

8-1020(C)

Figure 10. CW025 Dual Output-Series Typical Output Voltage Rise Time with Remote On/Off at  $V_i = V_{i, nom}$ ,  $I_o = 0.8 (I_{o, max})$  and  $T_c = 25\text{ }^\circ\text{C}$

Test Configurations

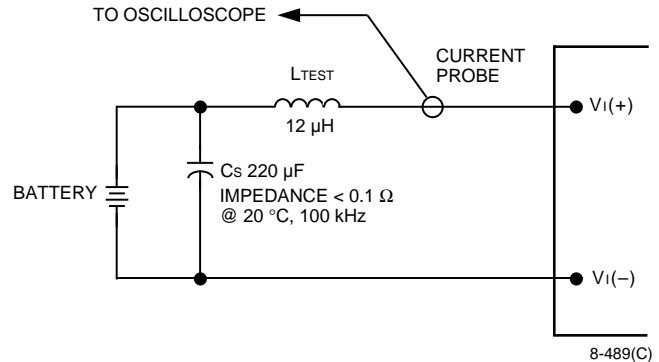

Note: Input reflected-ripple current is measured with a simulated source impedance ( $L_{TEST}$ ) of  $12\text{ }\mu\text{H}$ . Capacitor  $C_s$  offsets possible battery impedance. Current is measured at the input of the module.

Figure 11. Input Reflected-Ripple Test Setup

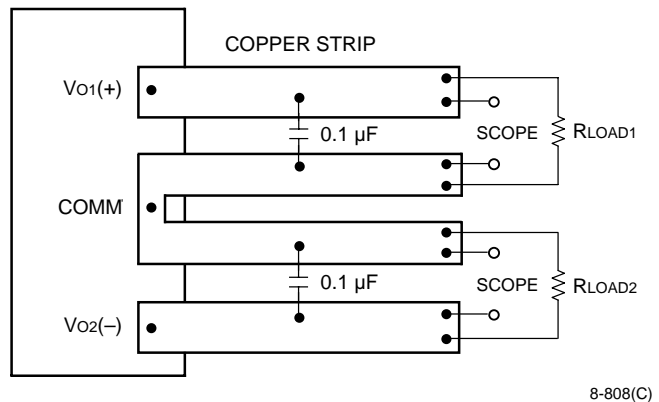

Note: Use a  $0.1\text{ }\mu\text{F}$  ceramic capacitor. Scope measurement should be made using a BNC socket. Position the load between  $50\text{ mm}$  (2 in.) and  $75\text{ mm}$  (3 in.) from the module.

Figure 12. Output Noise Measurement Test Setup



## Test Configurations (continued)

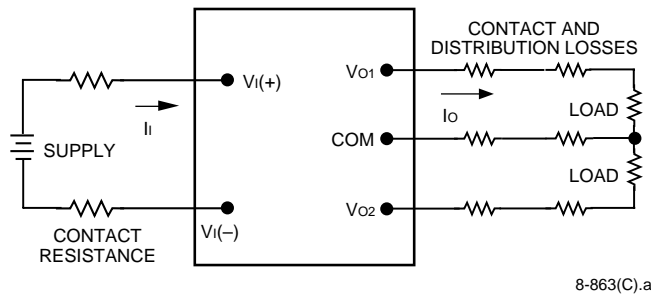

Note: All measurements are taken at the module terminals. When socketing, place Kelvin connections at module terminals to avoid measurement errors due to socket contact resistance.

$$\eta = \frac{\sum_{J=1}^2 |[VOJ - COM]IOJ|}{|VI(+)-VI(-)|I} \times 100$$

Figure 13. Output Voltage and Efficiency Measurement Test Setup

## Design Considerations

### Grounding Considerations

For modules without the isolated case ground pin option, the case is internally connected to the Vi(+) pin.

### Input Source Impedance

The power module should be connected to a low ac-impedance input source. Highly inductive source impedances can affect the stability of the power module. A 33  $\mu$ F electrolytic capacitor (ESR < 0.7  $\Omega$  at 100 kHz) mounted close to the power module helps ensure stability of the unit.

**Note:** Vi(+) is internally connected to the case for a standard module.

## Safety Considerations

For safety agency approval of the system in which the power module is used, the power module must be installed in compliance with the spacing and separation requirements of the end-use safety agency standard, i.e., *UL-1950*, *CSA 22.2-950*, *EN60950*.

For the converter output to be considered meeting the requirements of safety extra-low voltage (SELV), one of the following must be true of the dc input:

- All inputs are SELV and floating with the output also floating.
- All inputs are SELV and grounded with the output also grounded.
- Any non-SELV input must be provided with reinforced insulation from any other hazardous voltages, including the ac mains, and must have an SELV reliability test performed on it in combination with the converters.

The power module has extra-low voltage (ELV) outputs when all inputs are ELV.

The input to these units is to be provided with a maximum 5 A normal blow fuse in the ungrounded lead.

## Input/Output Voltage Reversal

**CAUTION:** Applying a reverse voltage across the module input or output forward biases an internal diode. Attempting to start the module under this condition can damage the module.

## Feature Descriptions

### Output Overvoltage Clamp

The output overvoltage clamp consists of control circuitry, independent of the primary regulation loop, that monitors the voltage on the output terminals. The control loop of the clamp has a higher voltage set point than the primary loop (see Feature Specifications table). This provides a redundant voltage control that reduces the risk of output overvoltage.

### Current Limit

To provide protection in a fault (output overload) condition, the unit is equipped with internal current-limiting circuitry and can endure current limiting for an unlimited duration. At the point of current-limit inception, the unit shifts from voltage control to current control. If the output voltage is pulled very low during a severe fault, the current-limit circuit can exhibit either foldback or tailout characteristics (output-current decrease or increase). The unit operates normally once the output current is brought back into its specified range.

## Remote On/Off

Two remote on/off options are available. Positive logic remote on/off turns the module on during a logic high voltage on the REMOTE ON/OFF pin, and off during a logic low. Negative logic remote on/off, code suffix "1," turns the module off during a logic high and on during a logic low.

To turn the power module on and off, the user must supply a switch to control the voltage between the on/off terminal and the  $V_{I(-)}$  terminal ( $V_{on/off}$ ). The switch can be an open collector or equivalent (see Figure 14). A logic low is  $V_{on/off} = 0$  V to 1.2 V. The maximum  $I_{on/off}$  during a logic low is 1 mA. The switch should maintain a logic low voltage while sinking 1 mA.

During a logic high, the maximum  $V_{on/off}$  generated by the power module is 10 V. The maximum allowable leakage current of the switch at  $V_{on/off} = 10$  V is 50  $\mu$ A.

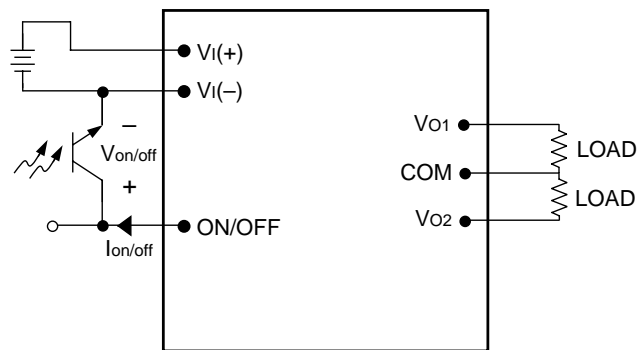

8-754(C)

Figure 14. Remote On/Off Implementation

## Thermal Considerations

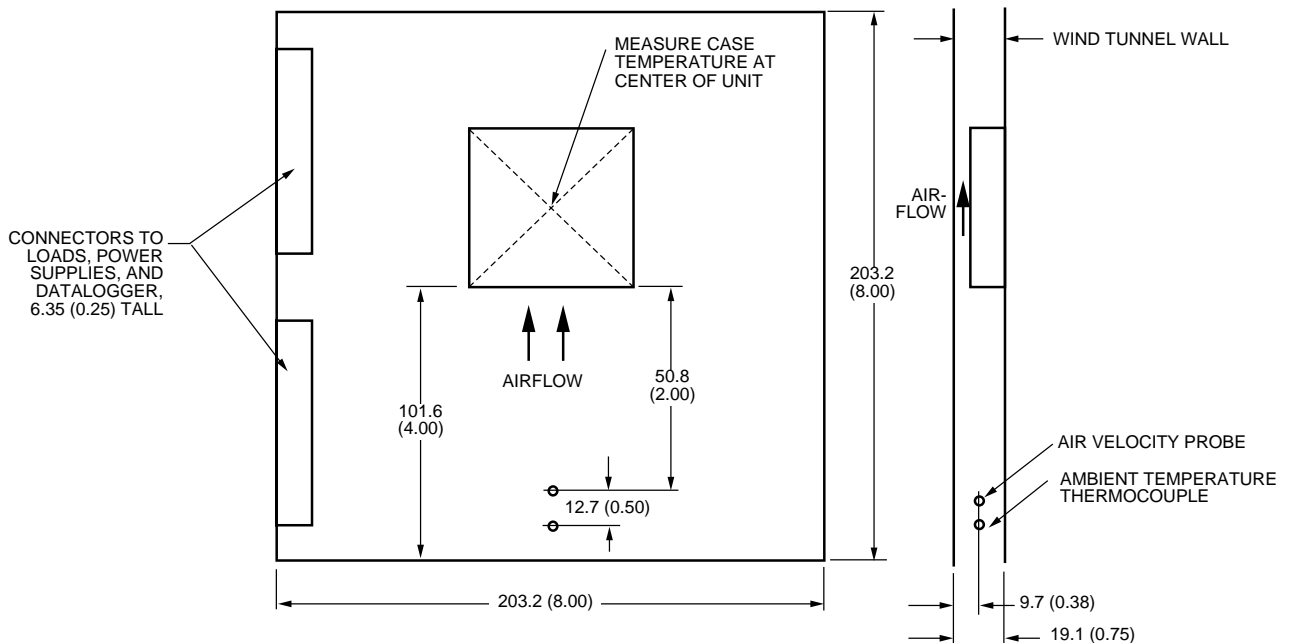

Note: Dimensions are in millimeters and (inches). Drawing is not to scale.

8-866(C).a

**Figure 15. Thermal Test Setup**

The 25 W dual output power modules are designed to operate in a variety of thermal environments. As with any electronic component, sufficient cooling must be provided to help ensure reliable operation of the unit. Heat-dissipating components inside the module are thermally coupled to the case. Heat is removed by conduction, convection, and radiation to the surrounding environment.

The thermal data presented is based on measurements taken in a wind tunnel. The test setup shown in Figure 15 was used to collect data. Actual performance can vary depending on the particular application environment.

## Basic Thermal Performance

The CW025 Dual Output-Series Power Modules have a separate power stage for each of the outputs. This means that the maximum operating temperature can be predicted quite closely by treating each output individually and then summing the results. Figures 16 through 19 are used to predict the safe operating condition for many different operating and environmental conditions.

The method used to determine the maximum ambient temperature at a given air velocity is a four-step process:

1. Find the power dissipated for output 1 by using the appropriate chart (Figures 16 through 18) for a particular output condition ( $I_{O1}$ ).
2. Repeat step 1 for output 2 using Figures 16 through 18.
3. Find the total power dissipated by summing the power dissipated on each of the outputs: ( $P_{Dout1} + P_{Dout2}$ ) =  $P_{Dtotal}$
4. Use the total power dissipated with Figure 19 to determine the maximum ambient temperature at different air velocities.

## Thermal Considerations (continued)

### Basic Thermal Performance (continued)

For example, the CW025AJ-M power module with a 54 V input and 2.5 A output on V<sub>O1</sub> and a 1.5 A output on V<sub>O2</sub> will have a power dissipated of 3.6 W (from Figure 16) plus 2.1 W (from Figure 16) or 5.7 W total. Using Figure 19, it can be determined that the maximum ambient temperature at natural convection that the CW025AJ-M can operate at is approximately 62 °C.

Keep in mind that these are approximations of the air temperature and velocity required to keep the case temperature below its maximum rating. The maximum case temperature at the point shown in Figure 15 must be kept at 100 °C or less.

### Air Velocity

The air velocity required to maintain a desired maximum case temperature for a given power dissipation and ambient temperature can be calculated by using Figure 19 and the following equation:

$$\theta_{CA} = \frac{T_{C, \max} - T_A}{P_{Dtotal}}$$

where  $\theta_{CA}$  is the thermal resistance from case-to-ambient air (°C/W),  $T_{C, \max}$  is the desired maximum case temperature (°C),  $T_A$  is the ambient inlet temperature (°C), and  $P_{Dtotal}$  is the total power dissipated from the module (W).

For example, to maintain a maximum case temperature of 85 °C with an ambient inlet temperature of 55 °C and a power dissipation of 6.7 W, the thermal resistance is:

$$\theta_{CA} \leq \frac{85^\circ\text{C} - 55^\circ\text{C}}{6.7\text{W}} = 4.5^\circ\text{C/W}$$

This corresponds to an air velocity greater than 0.46 ms<sup>-1</sup> (90 fpm) in Figure 19.

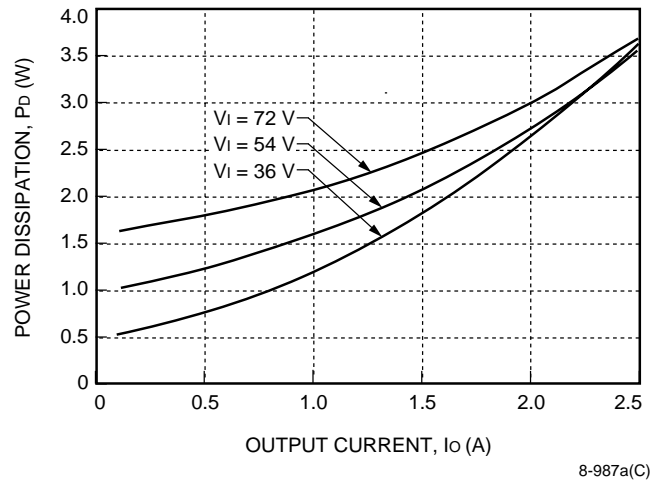

Figure 16. 5 V Output Power Dissipation vs. Output Current

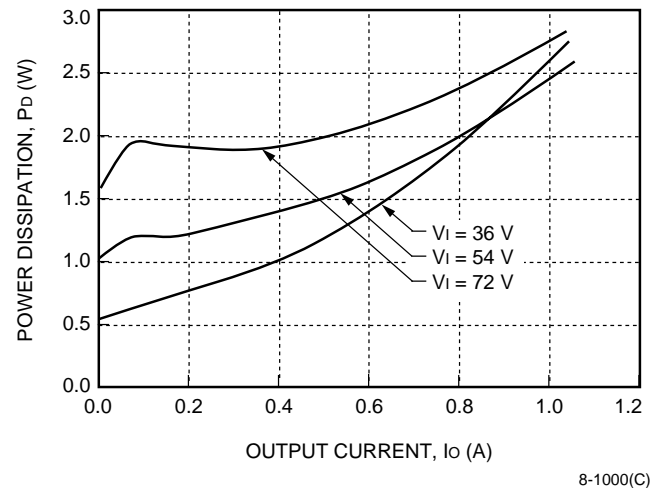
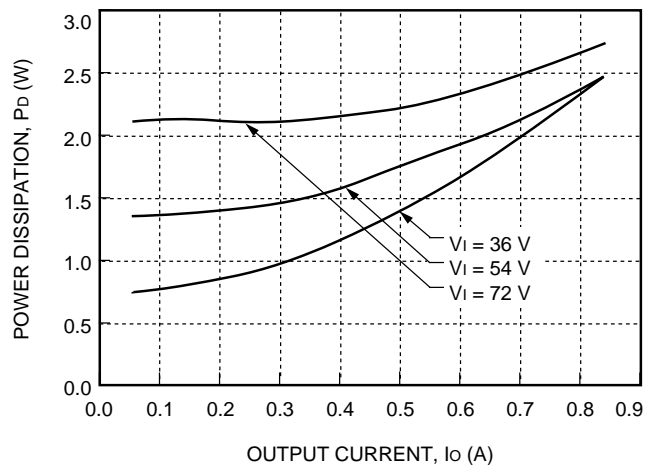

Figure 17. 12 V Output Power Dissipation vs. Output Current

Thermal Considerations (continued)

Air Velocity (continued)



8-999(C)

Figure 18. 15 V Output Power Dissipation vs. Output Current

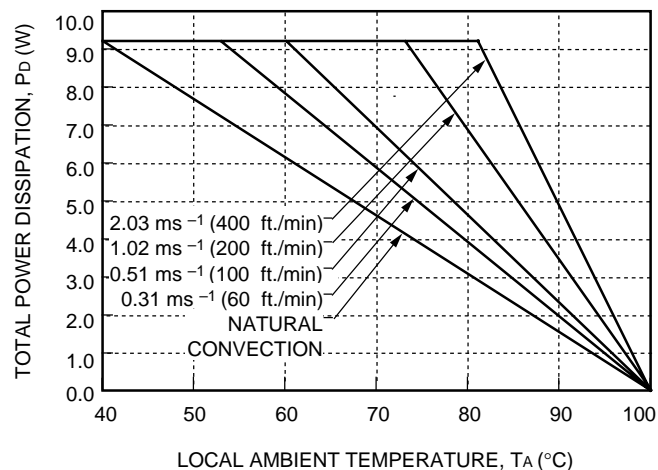

8-988(C)

Figure 19. Total Power Dissipation vs. Local Ambient Temperature and Air Velocity

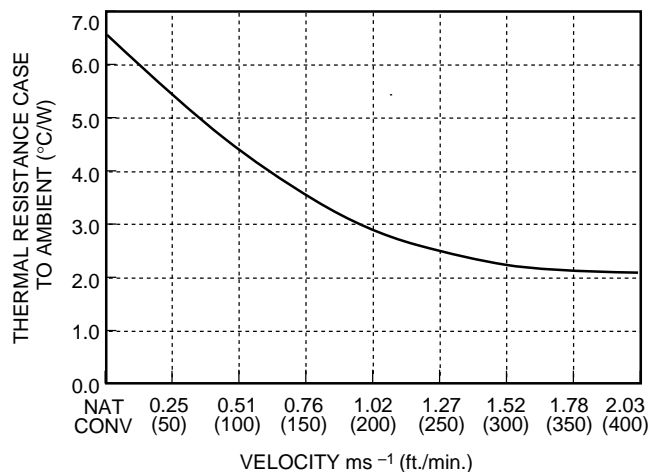

8-989(C)

Figure 20. Case-to-Ambient Thermal Resistance vs. Air Velocity

Use of Heat Sinks and Cold Plates

The CW025 Dual Output-Series case includes through-threaded M3 x 0.5 mounting holes allowing attachment of heat sinks or cold plates from either side of the module. The mounting torque must not exceed 0.56 N/m (5 in-lb.).

The following thermal model can be used to determine the required thermal resistance of the sink to provide the necessary cooling:

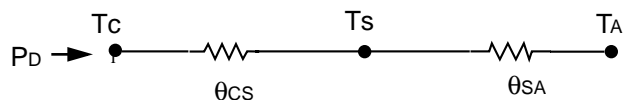

where  $P_D$  is the power dissipated by the module,  $\theta_{cs}$  represents the interfacial contact resistance between the module and the sink, and  $\theta_{SA}$  is the sink-to-ambient thermal impedance ( $^{\circ}\text{C}/\text{W}$ ). For thermal greases or foils, a value of  $\theta_{cs} = 0.1\text{ }^{\circ}\text{C}/\text{W}$  to  $0.3\text{ }^{\circ}\text{C}/\text{W}$  is typical.

The required  $\theta_{SA}$  is calculated from the following equation:

$$\theta_{SA} = \frac{T_C - T_A}{P_{Dtotal}} - \theta_{cs}$$

Note that this equation assumes that all dissipated power must be shed by the sink. Depending on the user-defined application environment, a more accurate model including heat transfer from the sides and rear of the module can be used. This equation provides a conservative estimate in such instances.

For further information, refer to the *Thermal Energy Management CC-, CW-, DC-Series 25 W to 30 W Board-Mounted Power Modules* Technical Note.

## Outline Diagrams

Dimensions are in millimeters and (inches).

Copper paths must not be routed beneath the power module standoffs.

Tolerances:  $x.x \pm 0.5$  mm (0.02 in.),  $x.xx \pm 0.25$  mm (0.010 in.).

**Note:** For standard modules,  $V_i(+)$  is internally connected to case.

### Top View

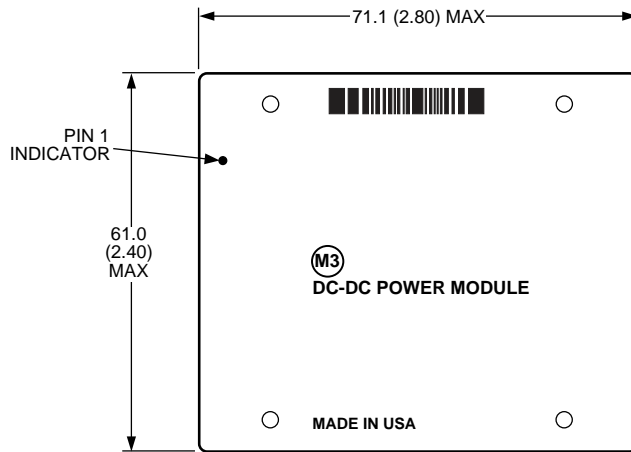

### Side View

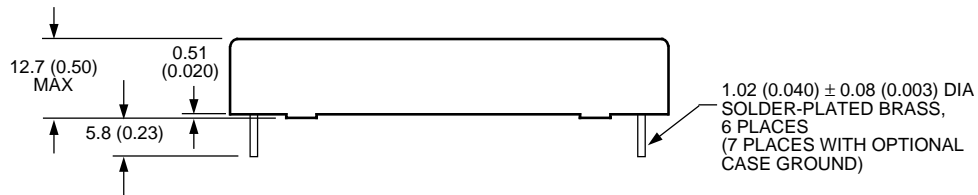

### Bottom View

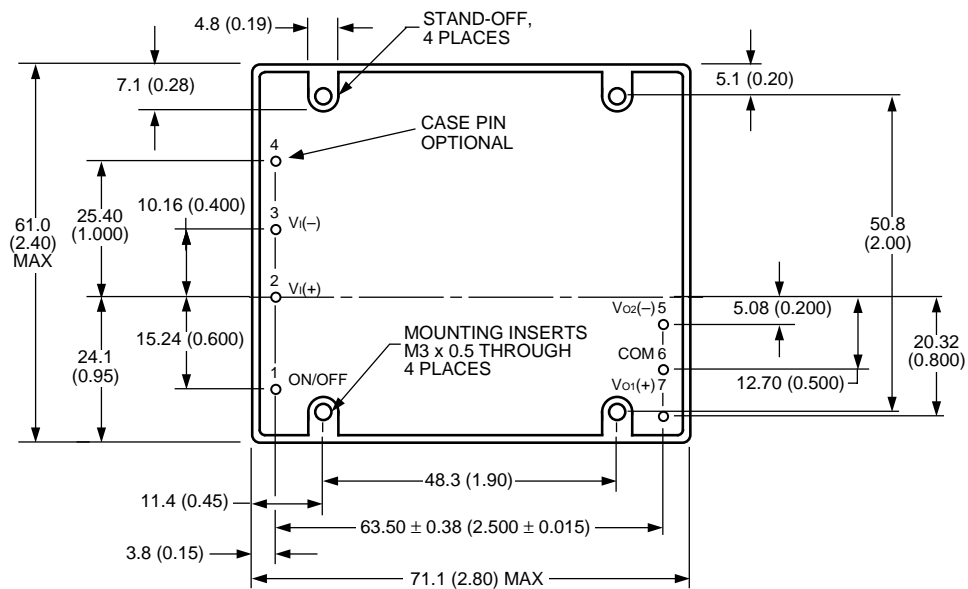

8-755(C).b

## Recommended Hole Pattern

Component-side footprint.

Dimensions are in millimeters and (inches).

Recommended hole size for pin: 1.27 mm (0.050 in.).

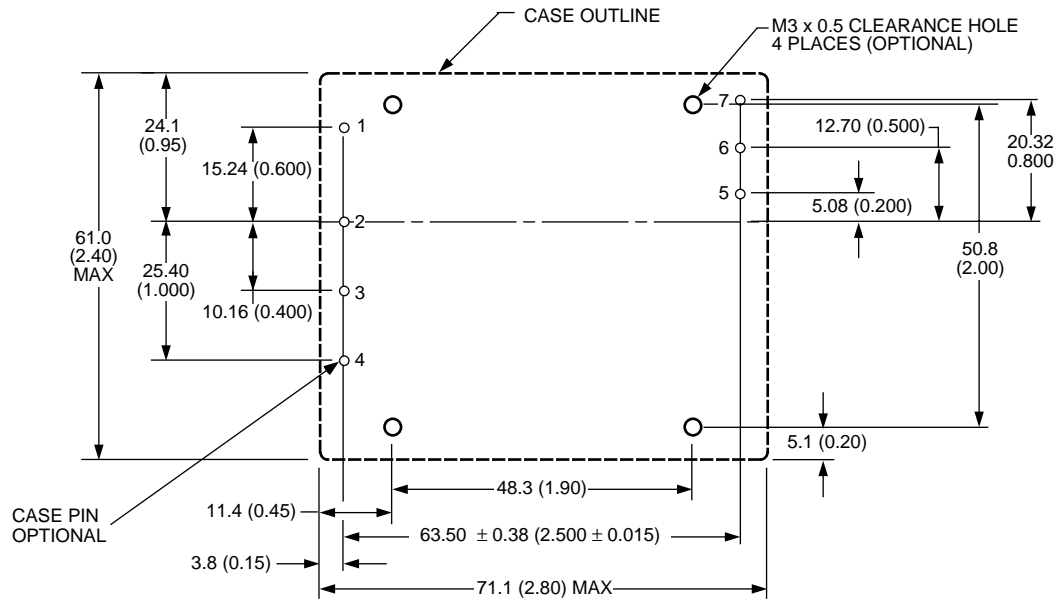

8-755(C).b

## Ordering Information

Table 4. Ordering Information Table

Input Voltage	Output Voltage	Output Power	Remote On/Off Logic	Device Code	Comcode
36 V—75 V	±5 V	25 W	positive	CW025AJ-M	107587230
36 V—75 V	±12 V	25 W	positive	CW025BK-M	107587248
36 V—75 V	±15 V	25 W	positive	CW025CL-M	107587255
36 V—75 V	±12 V	25 W	negative	CW025BK1-M	107637761

Optional features may be ordered using the device code suffixes shown below. To order more than one option, list suffixes in numerically descending order followed by the -M suffix, indicating metric (M3 x 0.5 heat sink hardware). The heat sinks designed for this package have an M prefix, i.e., MHSTxxx45 and MHSLxxx45 (see *Thermal Energy Management CC-, CW-, DC-, and DW-Series 25 W to 30 W Board-Mounted Power Modules* Technical Note).

Table 5. Options Table

Option	Device Code Suffix
Short pin: 2.79 mm ± 0.25 mm (0.110 in. ± 0.010 in.)	8
Isolated case ground pin	7
Negative logic remote on/off	1

Please contact your Lineage Power Account Manager or Field Application Engineer for pricing and availability.



**World Wide Headquarters**  
**Lineage Power Corporation**  
 3000 Skyline Drive, Mesquite, TX 75149, USA  
**+1-800-526-7819**  
 (Outside U.S.A.: +1-972-284-2626)  
**www.lineagepower.com**  
**e-mail: techsupport1@lineagepower.com**

**Asia-Pacific Headquarters**  
 Tel: +65 6 416 4283

**Europe, Middle-East and Africa Headquarters**  
 Tel: +49 89 6089 286

**India Headquarters**  
 Tel: +91 80 28411633

Lineage Power reserves the right to make changes to the product(s) or information contained herein without notice. No liability is assumed as a result of their use or application. No rights under any patent accompany the sale of any such product(s) or information.

© 2008 Lineage Power Corporation, (Mesquite, Texas) All International Rights Reserved.