

2N5194G, 2N5195G

Silicon PNP Power Transistors

These devices are designed for use in power amplifier and switching circuits; excellent safe area limits.

Features

- Complement to NPN 2N5191, 2N5192
- These Devices are Pb-Free and are RoHS Compliant*

MAXIMUM RATINGS (Note 1)

Rating	Symbol	Value	Unit
Collector-Emitter Voltage 2N5194G 2N5195G	V_{CEO}	60 80	Vdc
Collector-Base Voltage 2N5194G 2N5195G	V_{CB}	60 80	Vdc
Emitter-Base Voltage	V_{EB}	5.0	Vdc
Collector Current	I_C	4.0	Adc
Base Current	I_B	1.0	Adc
Total Device Dissipation @ $T_C = 25^\circ\text{C}$ Derate above 25°C	P_D	40 320	W W/ $^\circ\text{C}$
Operating and Storage Junction Temperature Range	T_J, T_{stg}	-65 to +150	$^\circ\text{C/W}$

Stresses exceeding those listed in the Maximum Ratings table may damage the device. If any of these limits are exceeded, device functionality should not be assumed, damage may occur and reliability may be affected.

1. Indicates JEDEC registered data.

THERMAL CHARACTERISTICS

Characteristic	Symbol	Max	Unit
Thermal Resistance, Junction-to-Case	$R_{\theta JC}$	3.12	$^\circ\text{C/W}$



ON Semiconductor®

<http://onsemi.com>

4 AMPERE POWER TRANSISTORS PNP SILICON 60 – 80 VOLTS

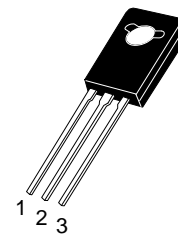
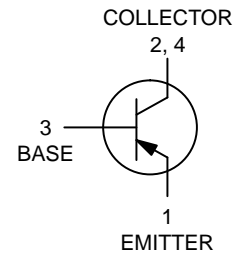

TO-225
CASE 77-09
STYLE 1

MARKING DIAGRAM

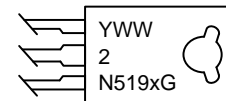

Y = Year
 WW = Work Week
 2N519x = Device Code
 x = 4 or 5
 G = Pb-Free Package

ORDERING INFORMATION

Device	Package	Shipping
2N5194G	TO-225 (Pb-Free)	500 Units / Bulk
2N5195G	TO-225 (Pb-Free)	500 Units / Bulk

*For additional information on our Pb-Free strategy and soldering details, please download the ON Semiconductor Soldering and Mounting Techniques Reference Manual, SOLDERRM/D.

2N5194G, 2N5195G

ELECTRICAL CHARACTERISTICS ($T_C = 25^\circ\text{C}$ unless otherwise noted) (Note 2)

Characteristic	Symbol	Min	Max	Unit
OFF CHARACTERISTICS				
Collector–Emitter Sustaining Voltage (Note 3) ($I_C = 0.1\text{ Adc}$, $I_B = 0$) 2N5194G 2N5195G	$V_{CE(sus)}$	60 80	– –	Vdc
Collector Cutoff Current ($V_{CE} = 60\text{ Vdc}$, $I_B = 0$) 2N5194G ($V_{CE} = 80\text{ Vdc}$, $I_B = 0$) 2N5195G	I_{CEO}	– –	1.0 1.0	mAdc
Collector Cutoff Current ($V_{CE} = 60\text{ Vdc}$, $V_{BE(off)} = 1.5\text{ Vdc}$) 2N5194G ($V_{CE} = 80\text{ Vdc}$, $V_{BE(off)} = 1.5\text{ Vdc}$) 2N5195G ($V_{CE} = 60\text{ Vdc}$, $V_{BE(off)} = 1.5\text{ Vdc}$, $T_C = 125^\circ\text{C}$) 2N5194G ($V_{CE} = 80\text{ Vdc}$, $V_{BE(off)} = 1.5\text{ Vdc}$, $T_C = 125^\circ\text{C}$) 2N5195G	I_{CEX}	– – – –	–0.1 0.1 2.0 2.0	mAdc
Collector Cutoff Current ($V_{CB} = 60\text{ Vdc}$, $I_E = 0$) 2N5194G ($V_{CB} = 80\text{ Vdc}$, $I_E = 0$) 2N5195G	I_{CBO}	– –	0.1 0.1	mAdc
Emitter Cutoff Current ($V_{BE} = 5.0\text{ Vdc}$, $I_C = 0$)	I_{EBO}	–	1.0	mAdc
ON CHARACTERISTICS				
DC Current Gain (Note 3) ($I_C = 1.5\text{ Adc}$, $V_{CE} = 2.0\text{ Vdc}$) 2N5194G 2N5195G ($I_C = 4.0\text{ Adc}$, $V_{CE} = 2.0\text{ Vdc}$) 2N5194G 2N5195G	h_{FE}	25 20 10 7.0	100 80 – –	–
Collector–Emitter Saturation Voltage (Note 3) ($I_C = 1.5\text{ Adc}$, $I_B = 0.15\text{ Adc}$) ($I_C = 4.0\text{ Adc}$, $I_B = 1.0\text{ Adc}$)	$V_{CE(sat)}$	– –	0.6 1.4	Vdc
Base–Emitter On Voltage (Note 3) ($I_C = 1.5\text{ Adc}$, $V_{CE} = 2.0\text{ Vdc}$)	$V_{BE(on)}$	–	1.2	Vdc
DYNAMIC CHARACTERISTICS				
Current–Gain – Bandwidth Product ($I_C = 1.0\text{ Adc}$, $V_{CE} = 10\text{ Vdc}$, $f = 1.0\text{ MHz}$)	f_T	2.0	–	MHz

Product parametric performance is indicated in the Electrical Characteristics for the listed test conditions, unless otherwise noted. Product performance may not be indicated by the Electrical Characteristics if operated under different conditions.

2. Indicates JEDEC registered data.

3. Pulse Test: Pulse Width $\leq 300\ \mu\text{s}$, Duty Cycle $\leq 2.0\%$.

2N5194G, 2N5195G

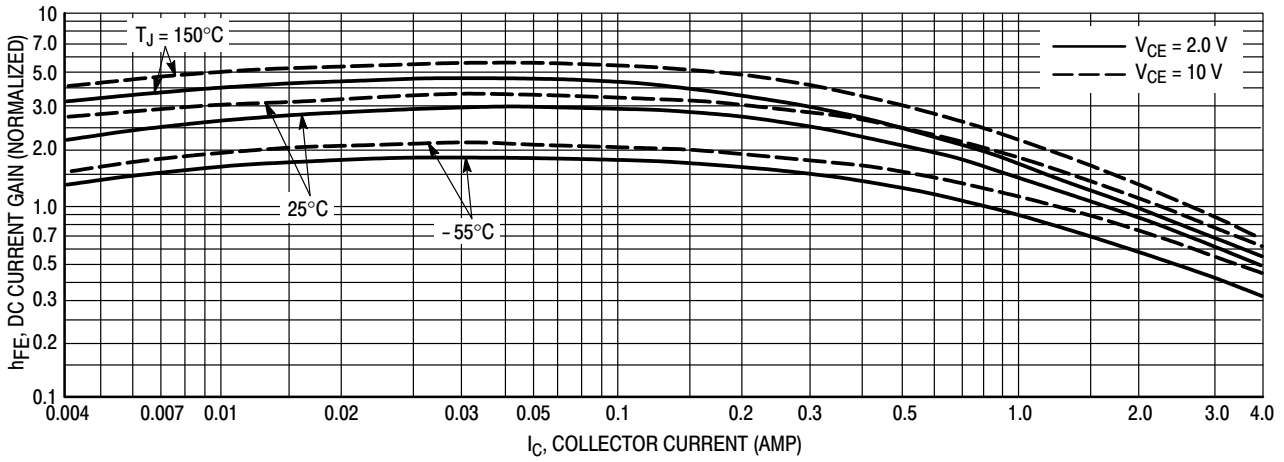

Figure 1. DC Current Gain

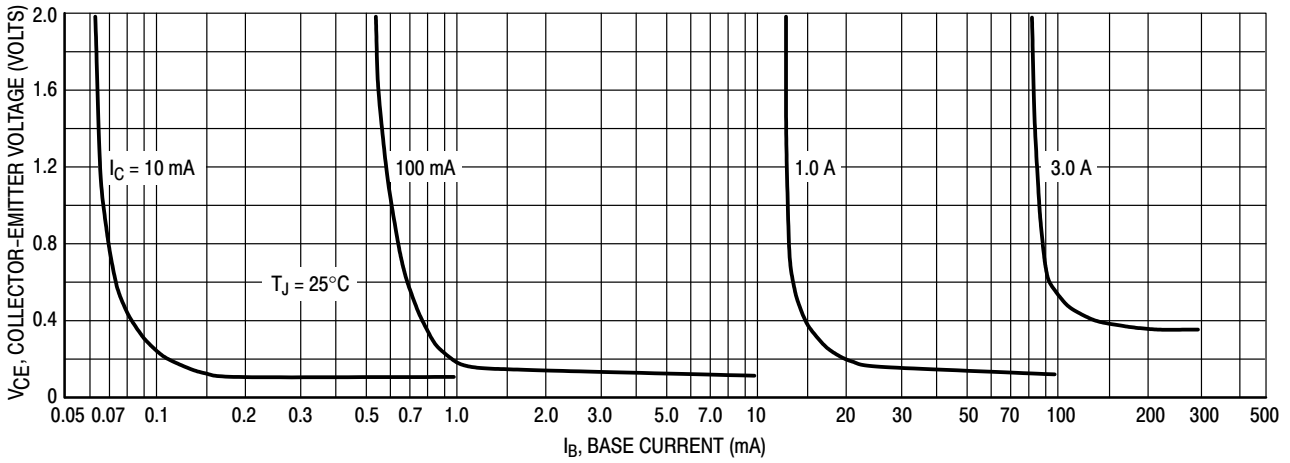

Figure 2. Collector Saturation Region

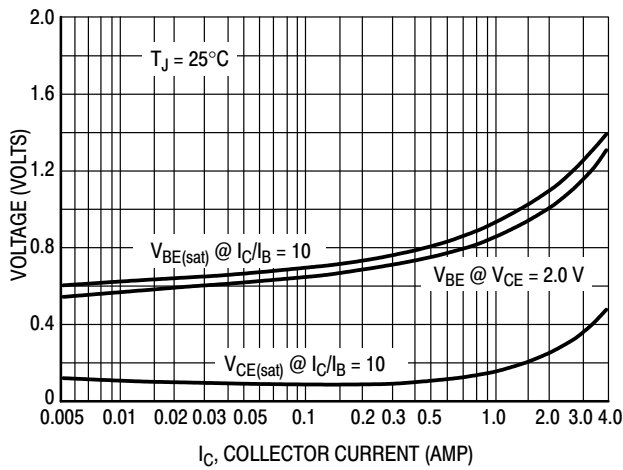

Figure 3. "On" Voltage

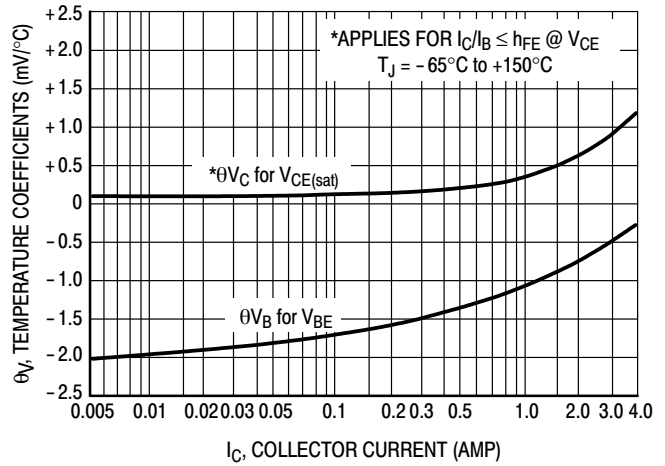

Figure 4. Temperature Coefficients

2N5194G, 2N5195G

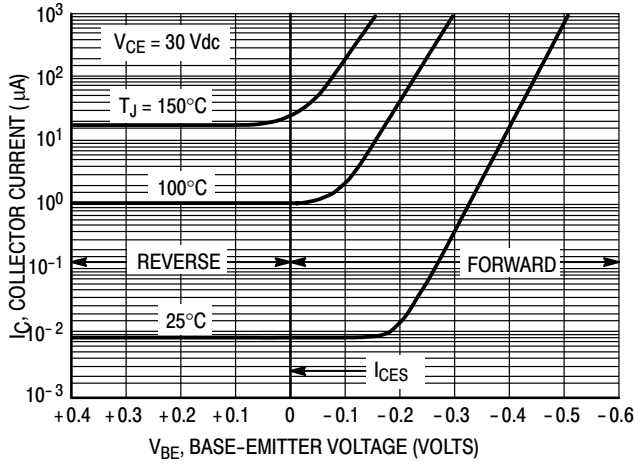

Figure 5. Collector Cut-Off Region

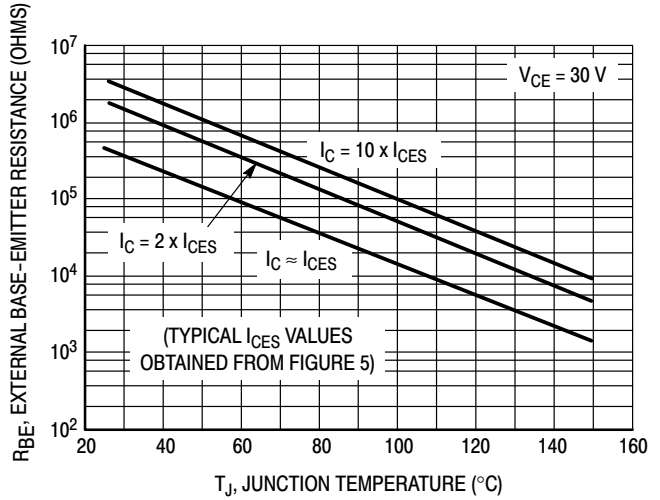

Figure 6. Effects of Base-Emitter Resistance

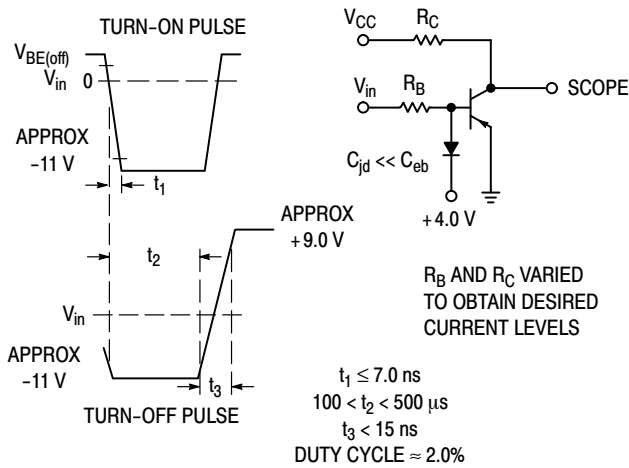

Figure 7. Switching Time Equivalent Test Circuit

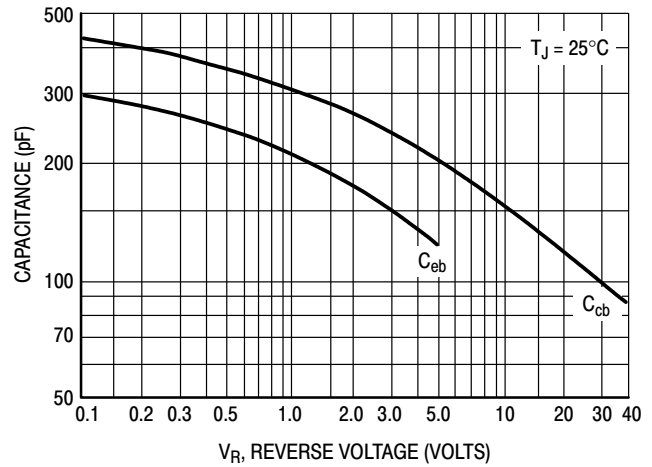

Figure 8. Capacitance

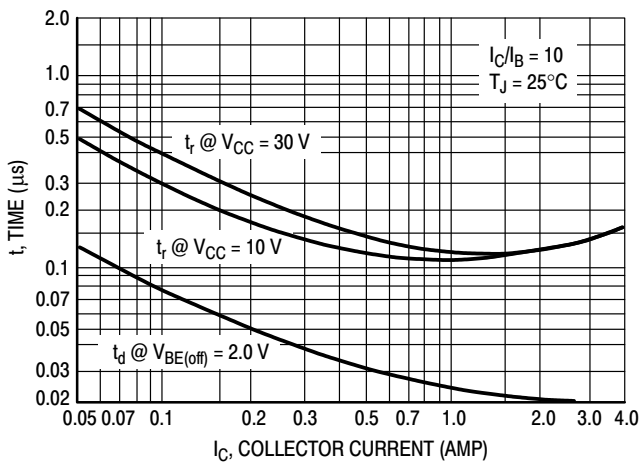

Figure 9. Turn-On Time

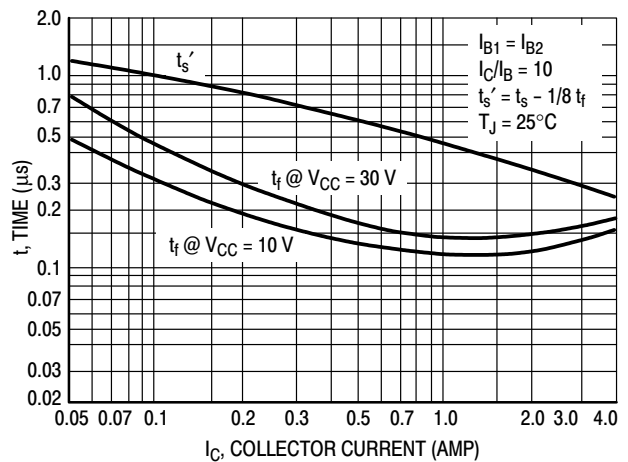
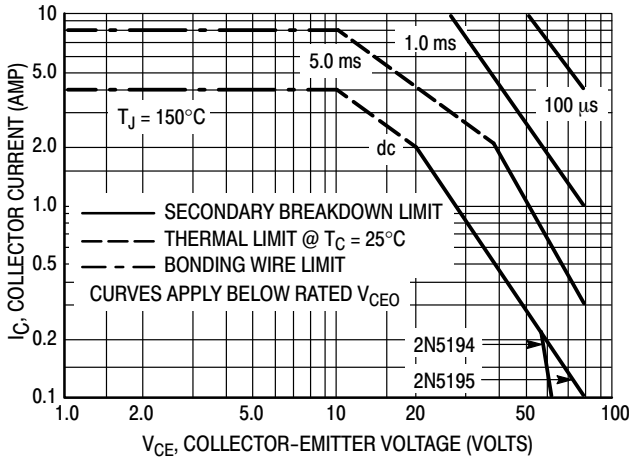

Figure 10. Turn-Off Time

2N5194G, 2N5195G



**Figure 11. Rating and Thermal Data
Active-Region Safe Operating Area**

Note 1:

There are two limitations on the power handling ability of a transistor; average junction temperature and second breakdown. Safe operating area curves indicate $I_C - V_{CE}$ limits of the transistor that must be observed for reliable operation; i.e., the transistor must not be subjected to greater dissipation than the curves indicate.

The data of Figure 11 is based on $T_{J(pk)} = 150^\circ\text{C}$. T_C is variable depending on conditions. Second breakdown pulse limits are valid for duty cycles to 10% provided $T_{J(pk)} \leq 150^\circ\text{C}$. At high-case temperatures, thermal limitations will reduce the power that can be handled to values less than the limitations imposed by second breakdown.

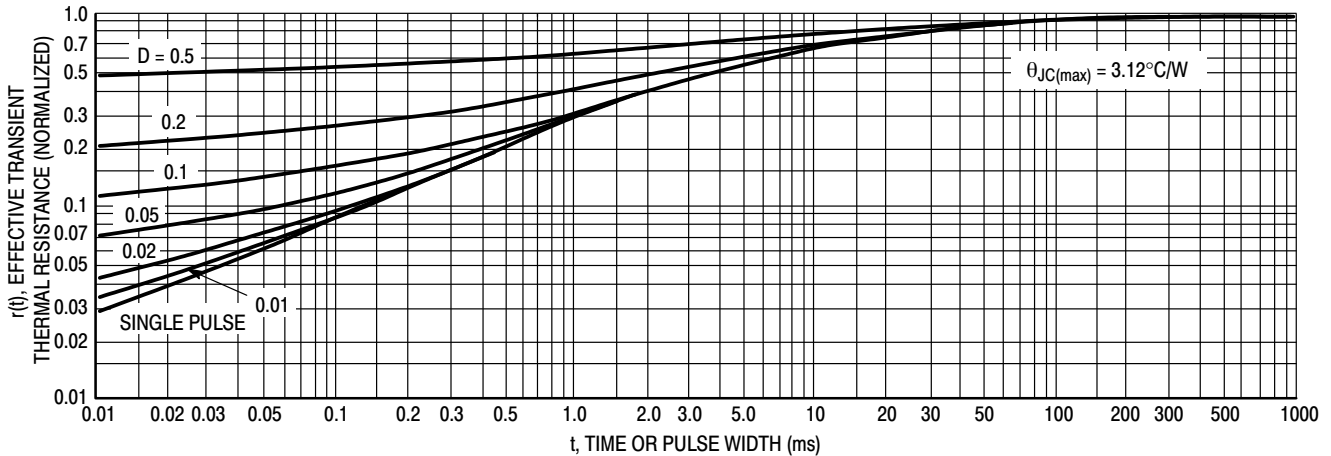

Figure 12. Thermal Response

DESIGN NOTE: USE OF TRANSIENT THERMAL RESISTANCE DATA

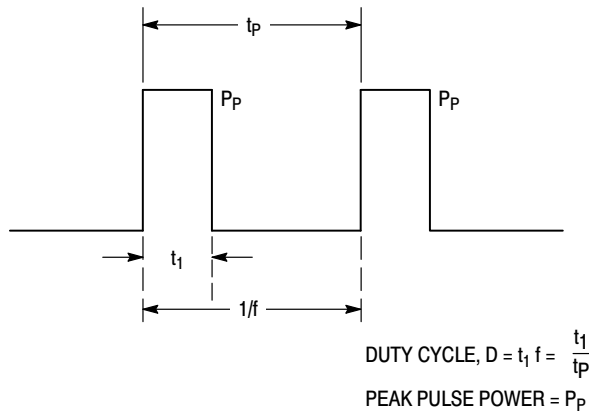

Figure 13.

A train of periodical power pulses can be represented by the model shown in Figure 13. Using the model and the device thermal response, the normalized effective transient thermal resistance of Figure 12 was calculated for various duty cycles.

To find $\theta_{JC}(t)$, multiply the value obtained from Figure 12 by the steady state value θ_{JC} .

Example:

The 2N5193 is dissipating 50 watts under the following conditions: $t_1 = 0.1$ ms, $t_p = 0.5$ ms. ($D = 0.2$).

Using Figure 12, at a pulse width of 0.1 ms and $D = 0.2$, the reading of $r(t_1, D)$ is 0.27.

The peak rise in junction temperature is therefore:

$$\Delta T = r(t) \times P_P \times \theta_{JC} = 0.27 \times 50 \times 3.12 = 42.2^\circ\text{C}$$

2N5194G, 2N5195G

PACKAGE DIMENSIONS

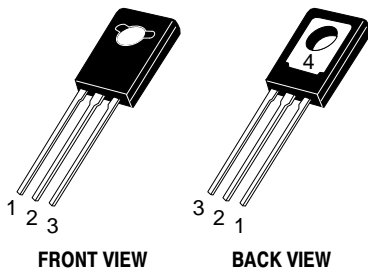

TO-225
CASE 77-09
ISSUE AC

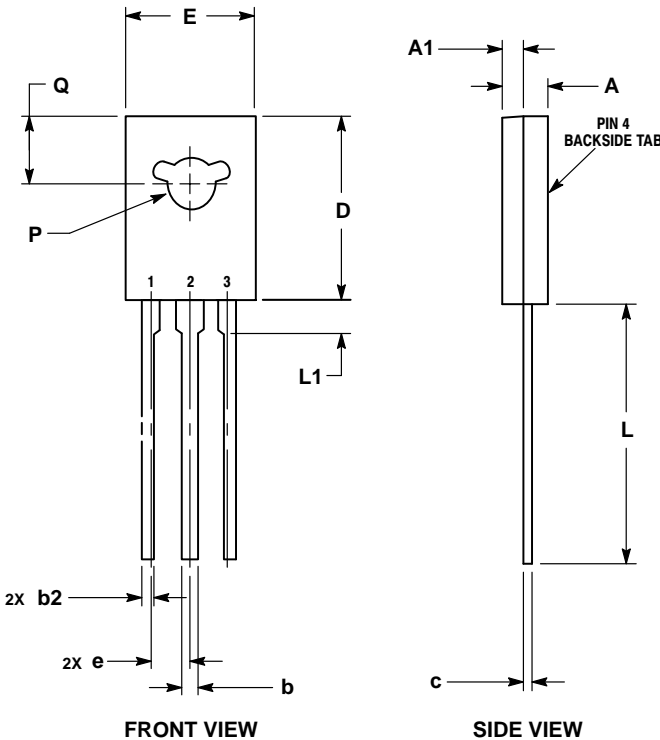

- NOTES:
1. DIMENSIONING AND TOLERANCING PER ASME Y14.5M, 1994.
 2. CONTROLLING DIMENSION: MILLIMETERS.
 3. NUMBER AND SHAPE OF LUGS OPTIONAL.

DIM	MILLIMETERS	
	MIN	MAX
A	2.40	3.00
A1	1.00	1.50
b	0.60	0.90
b2	0.51	0.88
c	0.39	0.63
D	10.60	11.10
E	7.40	7.80
e	2.04	2.54
L	14.50	16.63
L1	1.27	2.54
P	2.90	3.30
Q	3.80	4.20

- STYLE 1:
PIN 1. EMITTER
2., 4. COLLECTOR
3. BASE

ON Semiconductor and are registered trademarks of Semiconductor Components Industries, LLC (SCILLC). SCILLC owns the rights to a number of patents, trademarks, copyrights, trade secrets, and other intellectual property. A listing of SCILLC's product/patent coverage may be accessed at www.onsemi.com/site/pdf/Patent-Marking.pdf. SCILLC reserves the right to make changes without further notice to any products herein. SCILLC makes no warranty, representation or guarantee regarding the suitability of its products for any particular purpose, nor does SCILLC assume any liability arising out of the application or use of any product or circuit, and specifically disclaims any and all liability, including without limitation special, consequential or incidental damages. "Typical" parameters which may be provided in SCILLC data sheets and/or specifications can and do vary in different applications and actual performance may vary over time. All operating parameters, including "Typicals" must be validated for each customer application by customer's technical experts. SCILLC does not convey any license under its patent rights nor the rights of others. SCILLC products are not designed, intended, or authorized for use as components in systems intended for surgical implant into the body, or other applications intended to support or sustain life, or for any other application in which the failure of the SCILLC product could create a situation where personal injury or death may occur. Should Buyer purchase or use SCILLC products for any such unintended or unauthorized application, Buyer shall indemnify and hold SCILLC and its officers, employees, subsidiaries, affiliates, and distributors harmless against all claims, costs, damages, and expenses, and reasonable attorney fees arising out of, directly or indirectly, any claim of personal injury or death associated with such unintended or unauthorized use, even if such claim alleges that SCILLC was negligent regarding the design or manufacture of the part. SCILLC is an Equal Opportunity/Affirmative Action Employer. This literature is subject to all applicable copyright laws and is not for resale in any manner.

PUBLICATION ORDERING INFORMATION

LITERATURE FULFILLMENT:
Literature Distribution Center for ON Semiconductor
P.O. Box 5163, Denver, Colorado 80217 USA
Phone: 303-675-2175 or 800-344-3860 Toll Free USA/Canada
Fax: 303-675-2176 or 800-344-3867 Toll Free USA/Canada
Email: orderlit@onsemi.com

N. American Technical Support: 800-282-9855 Toll Free
USA/Canada
Europe, Middle East and Africa Technical Support:
Phone: 421 33 790 2910
Japan Customer Focus Center
Phone: 81-3-5817-1050

ON Semiconductor Website: www.onsemi.com
Order Literature: <http://www.onsemi.com/orderlit>
For additional information, please contact your local Sales Representative