

Description: 3G/GPRS/GSM + GNSS IP67

Series: Outdoor Multi Band

PART NUMBER: W4165XXX

Features:

- 3G antenna:
 - 824-960/1710-2170MHz
- Active GNSS antenna:
 - Beidou, GPS, Galileo, Glonass
 - LNA Gain 30dB
 - Pre and post LNA filtering
- RoHS Compliant
- Diameter 100mm
- IP67
- Cable and connector options shown on page 2.

Applications:

- Vehicular use
- Utility boxes
- Smart metering
- Navigation, Fleet Management, Tracking



All dimensions are in mm / inches

Issue: 1718

In the effort to improve our products, we reserve the right to make changes judged to be necessary.

CONFIDENTIAL AND PROPRIETARY INFORMATION

This document contains confidential and proprietary information of Pulse Electronics, Inc. (Pulse) and is protected by copyright, trade secret and other state and federal laws. Its receipt or possession does not convey any rights to reproduce, disclose its contents, or to manufacture, use or sell anything it may describe. Reproduction, disclosure or use without specific written authorization of Pulse is strictly forbidden.

For more information:

Pulse Worldwide Headquarters
15255 Innovation Drive #100
San Diego, CA 92128
USA
Tel: 1-858-674-8100

Pulse/Larsen Antennas
18110 SE 34th St Bldg 2 Suite 250
Vancouver, WA 98683
USA
Tel: 1-360-944-7551

Europe Headquarters
Pulse GmbH & Do, KG
Zeppelinstrasse 15
Herrenberg, Germany
Tel: 49 7032 7806 0

Pulse (Suzhou) Wireless Products Co, Inc.
99 Huo Ju Road(#29 Bldg,4th Phase
Suzhou New District
Jiangsu Province, Suzhou 215009 PR China
Tel: 86 512 6807 9998



Description: 3G/GPRS/GSM + GNSS IP67

Series: Outdoor Multi Band

PART NUMBER: W4165XXX

This document covers all product variants of the following product family

Antennas	GSM Cable			GPS Cable		
	Cable Type	Cable Length	Connector	Cable Type	Cable Length	Connector
W4165	RG-174 Black	4000mm/157.5"/13.2'	SMA Male	RG-174 Black	4000mm/157.5"/13.2'	SMA Male
W4165AI		1524mm/60"/5'	TNC Male		1524mm/60"/5'	RP-TNC Male
W4165SMA5		1524mm/60"/5'	SMA Male		1524mm/60"/5'	SMA Male
W4165RPSMA10		3048mm/120"/10'	RP-SMA Male		3048mm/120"/10'	RP-SMA Male

Issue: 1718

In the effort to improve our products, we reserve the right to make changes judged to be necessary.

CONFIDENTIAL AND PROPRIETARY INFORMATION

This document contains confidential and proprietary information of Pulse Electronics, Inc. (Pulse) and is protected by copyright, trade secret and other state and federal laws. Its receipt or possession does not convey any rights to reproduce, disclose its contents, or to manufacture, use or sell anything it may describe. Reproduction, disclosure or use without specific written authorization of Pulse is strictly forbidden.

ELECTRICAL SPECIFICATIONS

Frequency (GSM)	824-960/1710-2170 MHz
Frequency (Beidou,GPS,Galileo,Glonass)	1561.098±2.046/ 1575.42±1.023/ 1602.5625±4MHz
Nominal Impedance	50 Ω
VSWR** (GSM)	< 2:1
Average Peak Gain* (GSM antenna, Low band, typical)	4 dB
Average Peak Gain* (GSM antenna, High band, typical)	4.5 dB
GNSS antenna RHCP gain	1 dBic ± 2 dB
LNA gain	30 dB ± 2 dB
Noise Figure	2.5 (cascade) dB
Current	9 mA ± 2 mA
Vdc	3-5Vdc
LNA and filter attenuation	
	@ 824 MHz 70 dB
	@960 MHz 65 dB
	@1710 MHz 60 dB
	@2170 MHz 65 dB

*Measured on diameter 500mm GND plane and with 5 inch cables

** Measured on diameter 500mm GND plane and with 10 feet cables

Description: 3G/GPRS/GSM + GNSS IP67

Series: Outdoor Multi Band

PART NUMBER: W4165XXX

MECHANICAL SPECIFICATIONS

Antenna Color / Material	Black
Connector type	As requested
Cable type	RG-174, Black
Cable length	As requested
Fixing system	Direct Mount
	P.S. requires a 3/4" (19mm) hole in the mounting surface.
Connector retention	30 N
Strain relief	30 N, applied to cable along axis and perpendicular to cable entry

ENVIRONMENTAL SPECIFICATIONS

Operating Temperature	-40 ~ 85° C
Storage Temperature	-40 ~ 85° C
Ingress Protection	IP67
Wind-loading	160 km/h
RoHS Compliant	Yes

Issue: 1718

In the effort to improve our products, we reserve the right to make changes judged to be necessary.

CONFIDENTIAL AND PROPRIETARY INFORMATION

This document contains confidential and proprietary information of Pulse Electronics, Inc. (Pulse) and is protected by copyright, trade secret and other state and federal laws. Its receipt or possession does not convey any rights to reproduce, disclose its contents, or to manufacture, use or sell anything it may describe. Reproduction, disclosure or use without specific written authorization of Pulse is strictly forbidden.

Description: 3G/GPRS/GSM + GNSS IP67

Series: Outdoor Multi Band

PART NUMBER: W4165XXX

MECHANICAL DRAWING

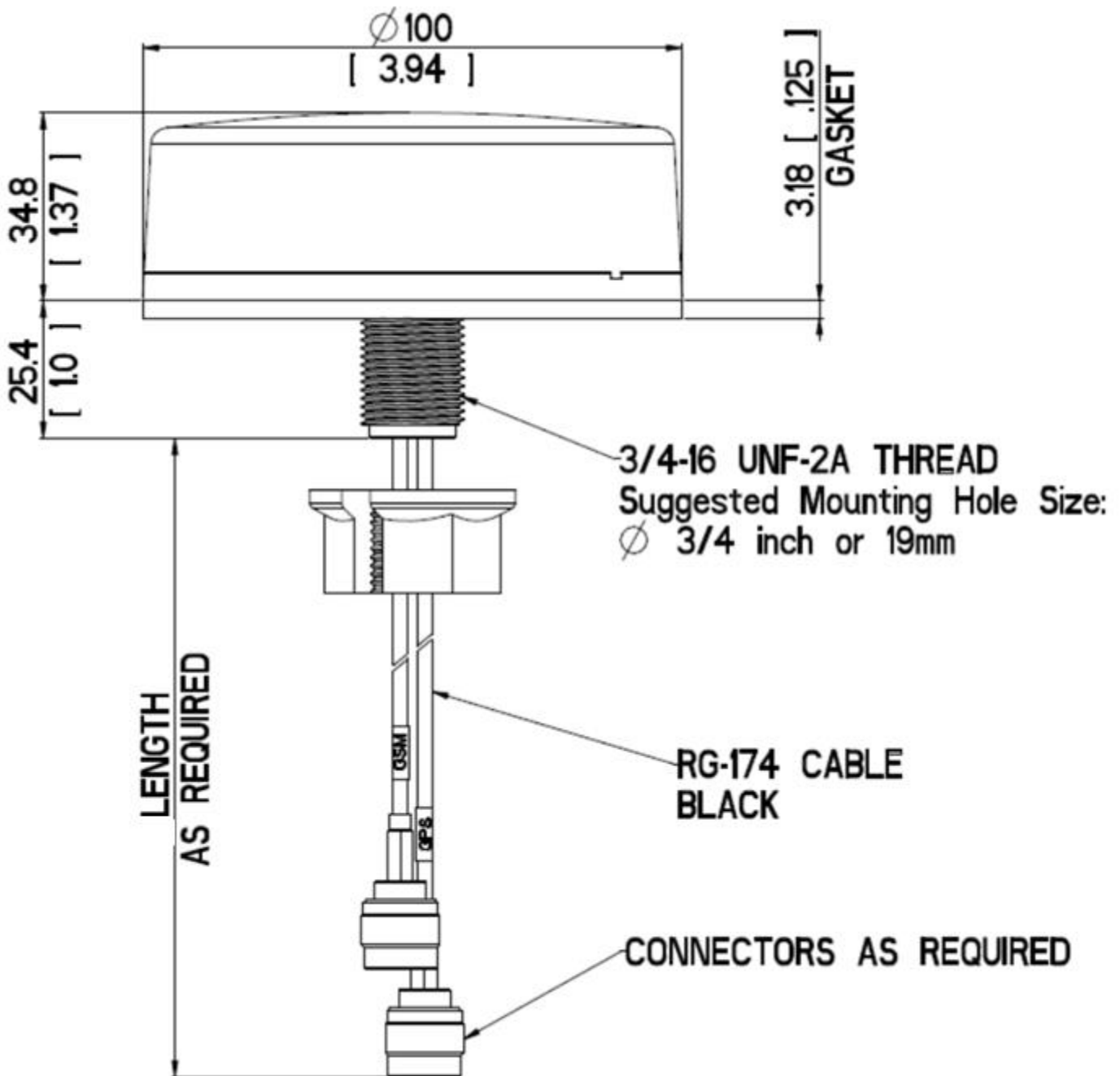

Issue: 1718

In the effort to improve our products, we reserve the right to make changes judged to be necessary.

CONFIDENTIAL AND PROPRIETARY INFORMATION

This document contains confidential and proprietary information of Pulse Electronics, Inc. (Pulse) and is protected by copyright, trade secret and other state and federal laws. Its receipt or possession does not convey any rights to reproduce, disclose its contents, or to manufacture, use or sell anything it may describe. Reproduction, disclosure or use without specific written authorization of Pulse is strictly forbidden.

Description: 3G/GPRS/GSM + GNSS IP67

Series: Outdoor Multi Band

PART NUMBER: W4165XXX

TEST SETUP

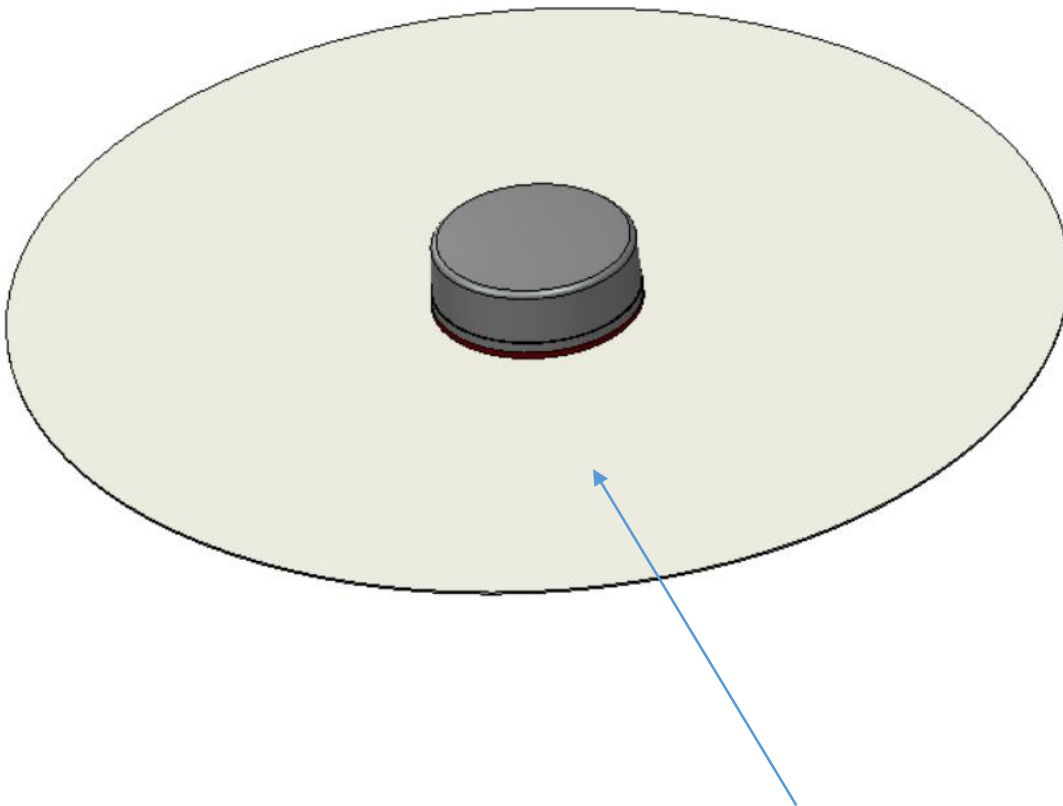

Diameter: 500 mm ground pane

CHARTS

VSWR*

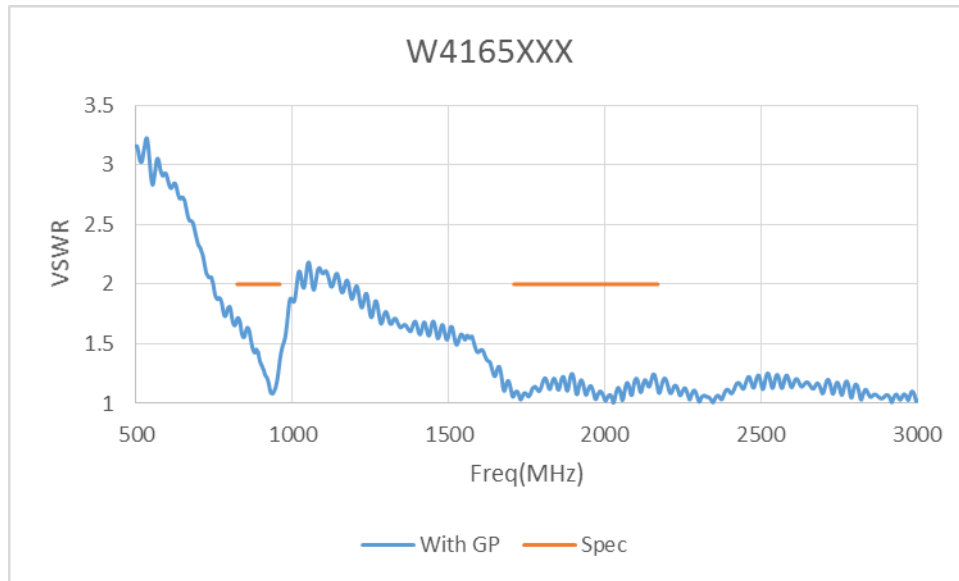

GNSS LNA performance

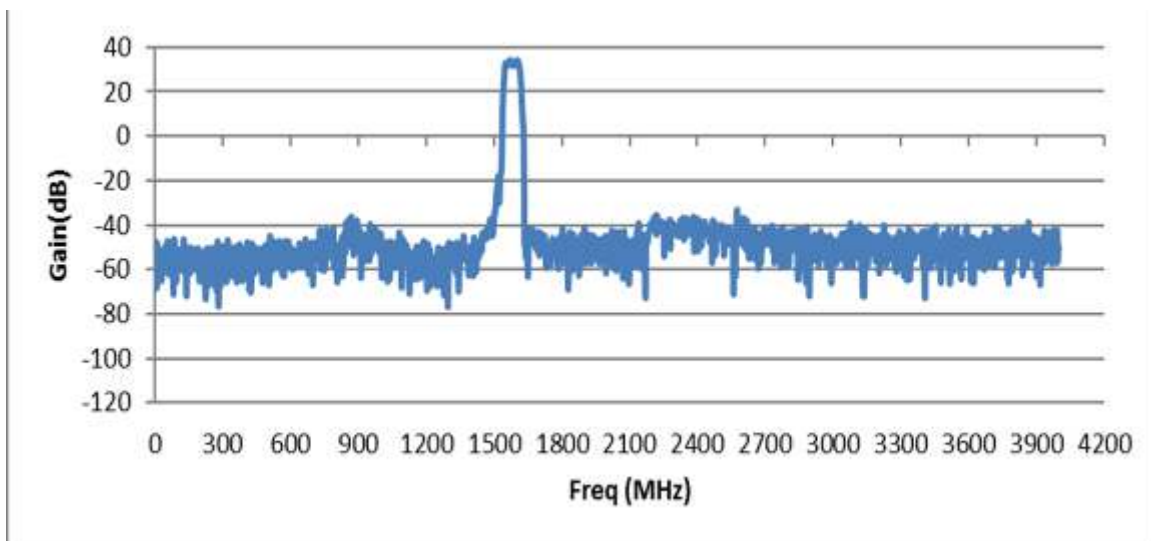

CHARTS

GSM antenna total efficiency*

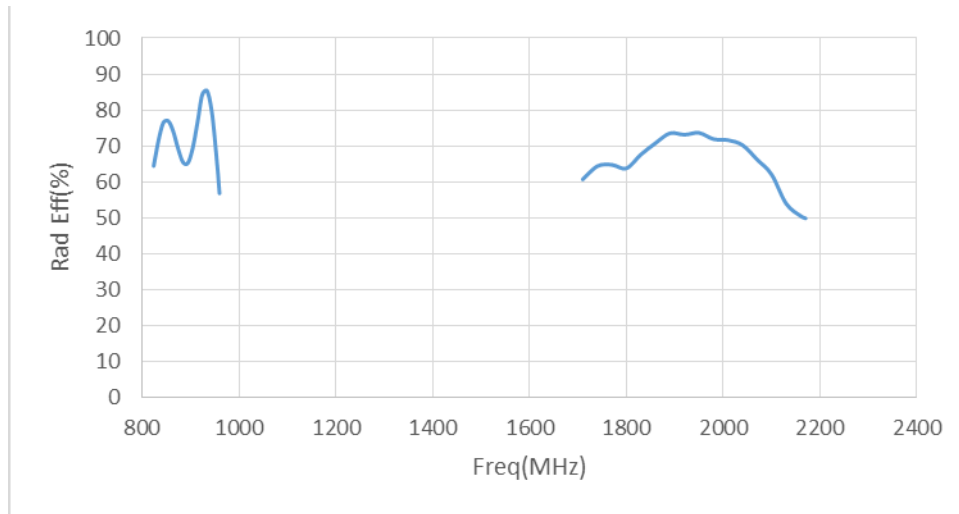

Maximum 3D gain, GSM antenna*

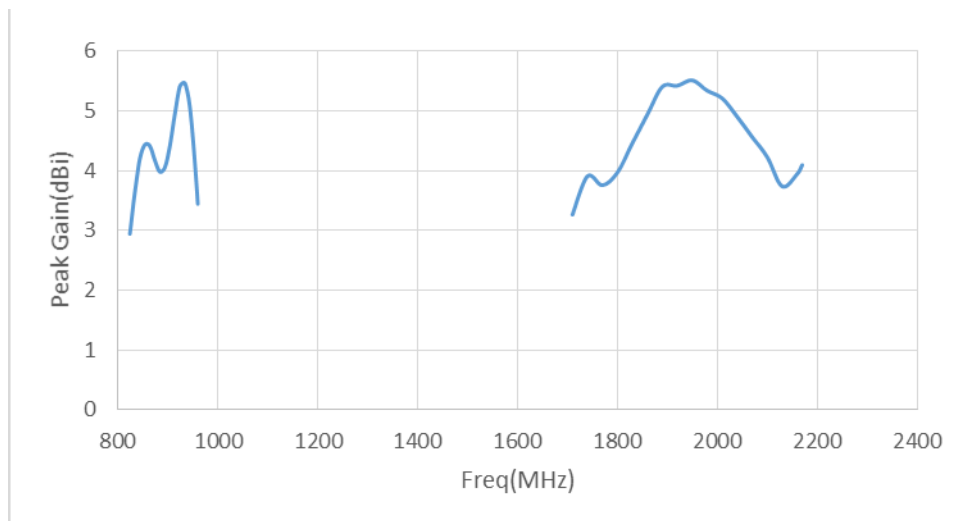

Issue: 1718

In the effort to improve our products, we reserve the right to make changes judged to be necessary.

CONFIDENTIAL AND PROPRIETARY INFORMATION

This document contains confidential and proprietary information of Pulse Electronics, Inc. (Pulse) and is protected by copyright, trade secret and other state and federal laws. Its receipt or possession does not convey any rights to reproduce, disclose its contents, or to manufacture, use or sell anything it may describe. Reproduction, disclosure or use without specific written authorization of Pulse is strictly forbidden.

CHARTS

GSM antenna Low band Radiation Pattern X-Y Plane*

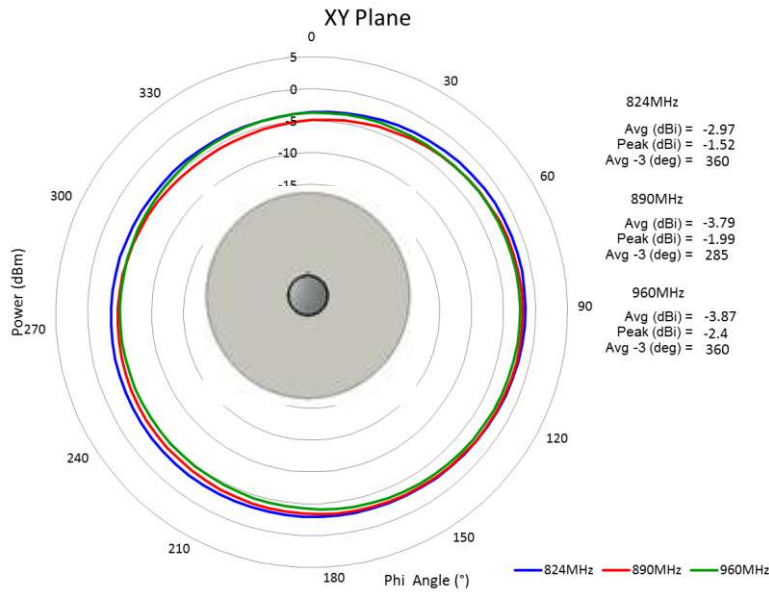

GSM antenna Low band Radiation Pattern Z-X Plane*

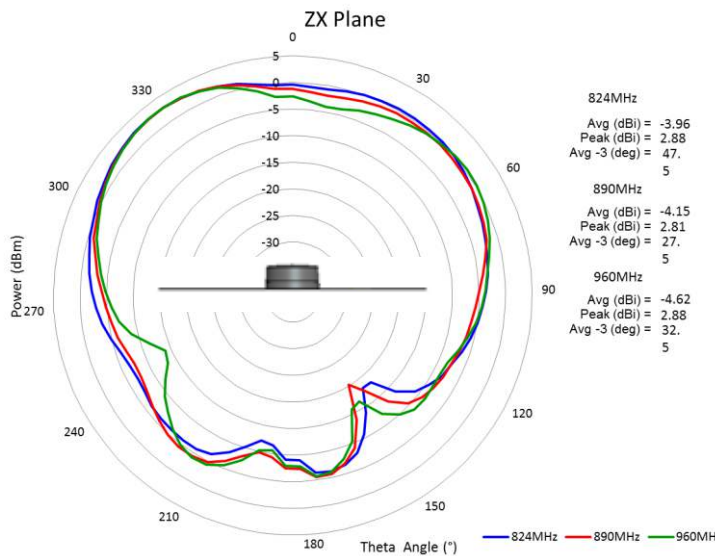

Issue: 1718

In the effort to improve our products, we reserve the right to make changes judged to be necessary.

CONFIDENTIAL AND PROPRIETARY INFORMATION

This document contains confidential and proprietary information of Pulse Electronics, Inc. (Pulse) and is protected by copyright, trade secret and other state and federal laws. Its receipt or possession does not convey any rights to reproduce, disclose its contents, or to manufacture, use or sell anything it may describe. Reproduction, disclosure or use without specific written authorization of Pulse is strictly forbidden.

CHARTS

GSM antenna Low band Radiation Pattern Y-Z Plane*

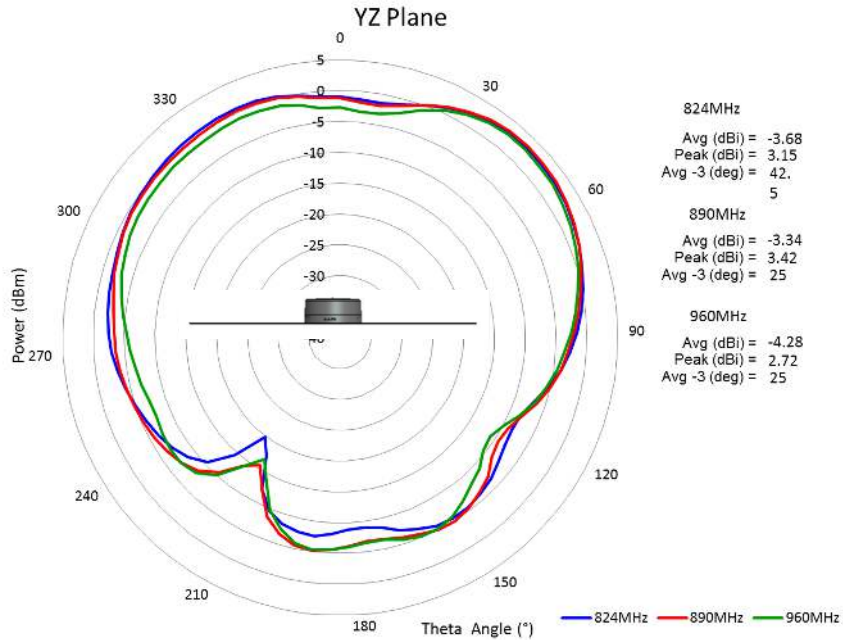

GSM antenna High band Radiation Pattern X-Y Plane*

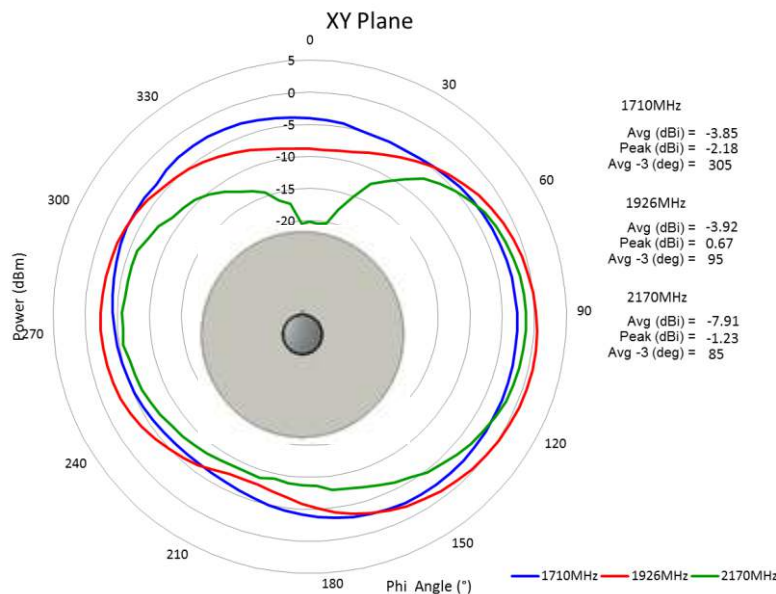

Issue: 1718

In the effort to improve our products, we reserve the right to make changes judged to be necessary.

CONFIDENTIAL AND PROPRIETARY INFORMATION

This document contains confidential and proprietary information of Pulse Electronics, Inc. (Pulse) and is protected by copyright, trade secret and other state and federal laws. Its receipt or possession does not convey any rights to reproduce, disclose its contents, or to manufacture, use or sell anything it may describe. Reproduction, disclosure or use without specific written authorization of Pulse is strictly forbidden.

CHARTS

GSM antenna High band Radiation Pattern Z-X Plane*

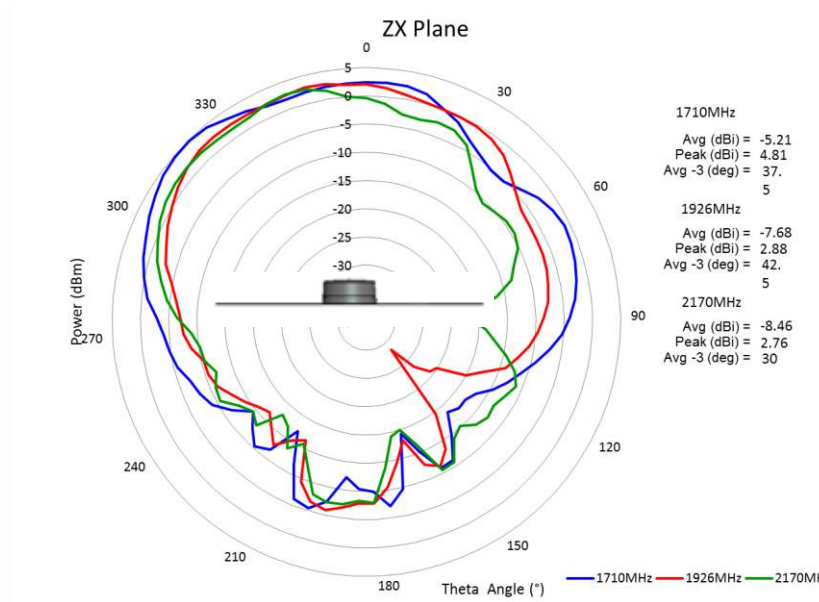

GSM antenna High band Radiation Pattern Y-Z Plane*

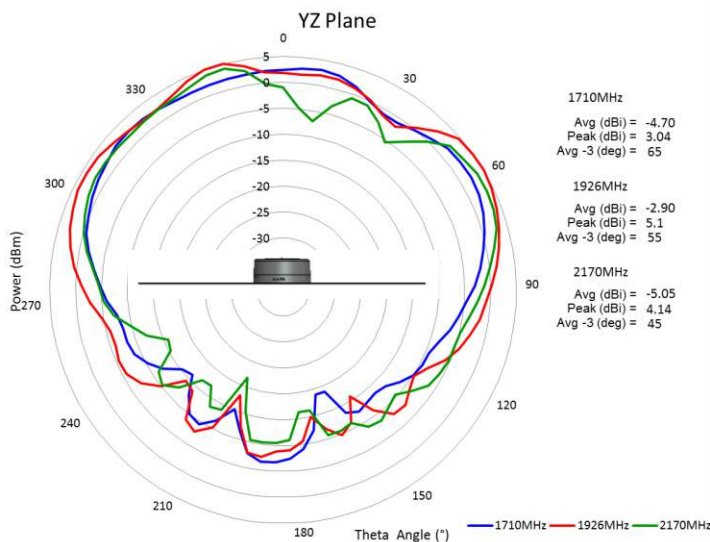

Issue: 1718

In the effort to improve our products, we reserve the right to make changes judged to be necessary.

CONFIDENTIAL AND PROPRIETARY INFORMATION

This document contains confidential and proprietary information of Pulse Electronics, Inc. (Pulse) and is protected by copyright, trade secret and other state and federal laws. Its receipt or possession does not convey any rights to reproduce, disclose its contents, or to manufacture, use or sell anything it may describe. Reproduction, disclosure or use without specific written authorization of Pulse is strictly forbidden.

Description: 3G/GPRS/GSM + GNSS IP67

Series: Outdoor Multi Band

PART NUMBER: W4165XXX

CHARTS

RHCP Radiation Pattern (70mm x 70mm ground plane) GPS & Galileo

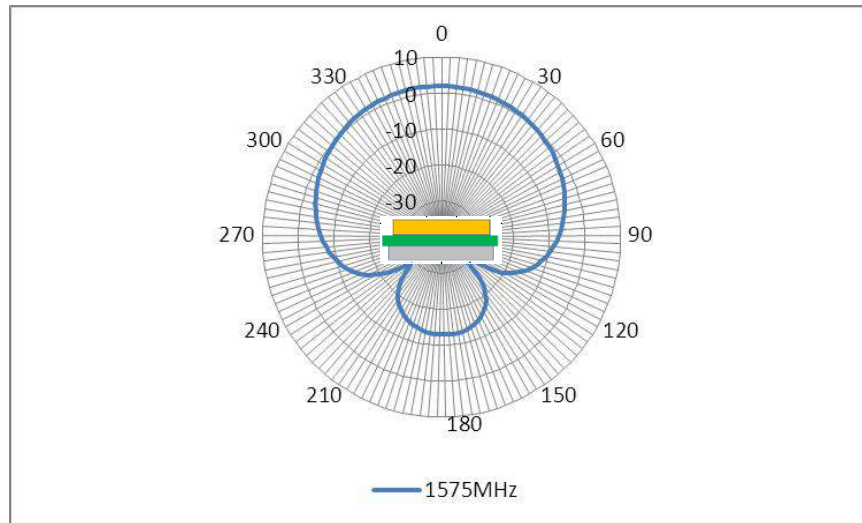

RHCP Radiation Pattern (70mm x 70mm ground plane) GLONASS

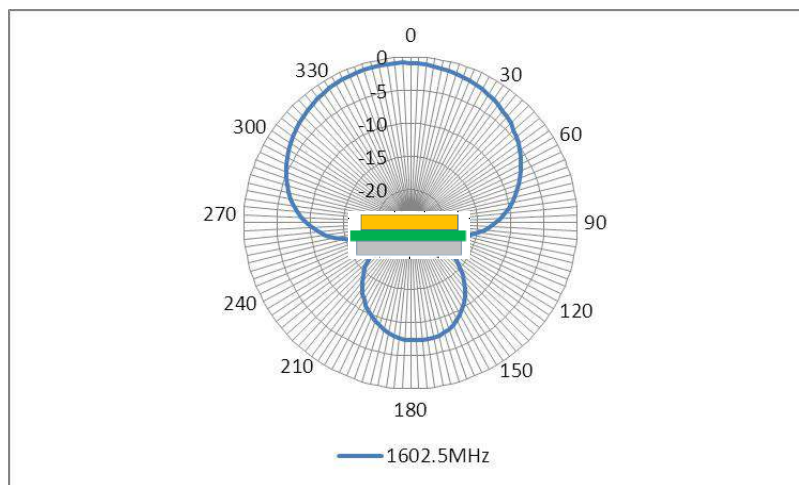

Issue: 1718

In the effort to improve our products, we reserve the right to make changes judged to be necessary.

CONFIDENTIAL AND PROPRIETARY INFORMATION

This document contains confidential and proprietary information of Pulse Electronics, Inc. (Pulse) and is protected by copyright, trade secret and other state and federal laws. Its receipt or possession does not convey any rights to reproduce, disclose its contents, or to manufacture, use or sell anything it may describe. Reproduction, disclosure or use without specific written authorization of Pulse is strictly forbidden.

Description: 3G/GPRS/GSM + GNSS IP67

Series: Outdoor Multi Band

PART NUMBER: W4165XXX

CHARTS

RHCP Radiation Pattern (70mm x 70mm ground plane) BD2

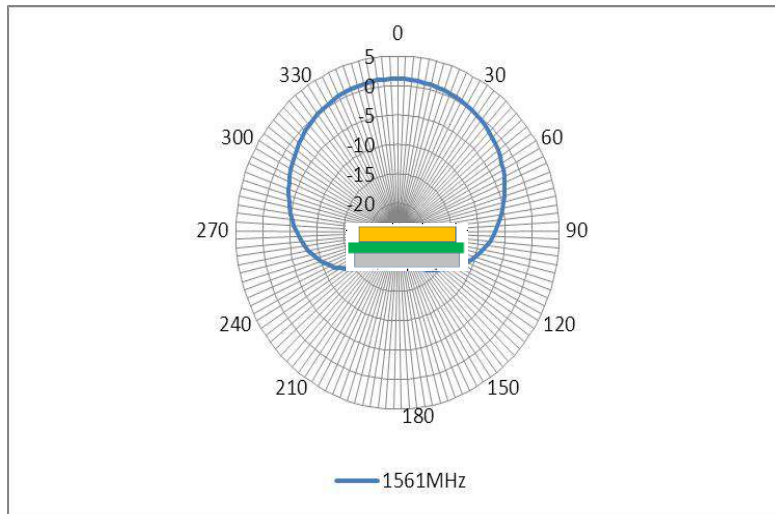

Description: 3G/GPRS/GSM + GNSS IP67

Series: Outdoor Multi Band

PART NUMBER: W4165XXX

PACKAGING

1 antenna packed in a plastic bag

12 plastic bags of antennas packed in a carton

1 label on each carton with part number, description, date code.