

PCB VIEWING HOLES  
 DETAIL A  
 SCALE 5:1

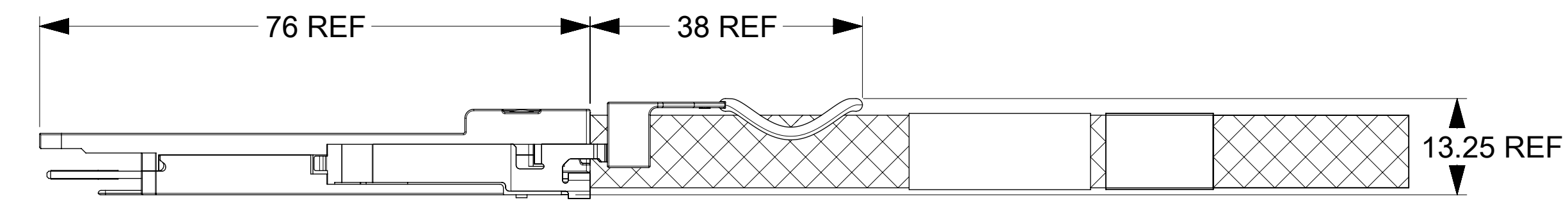
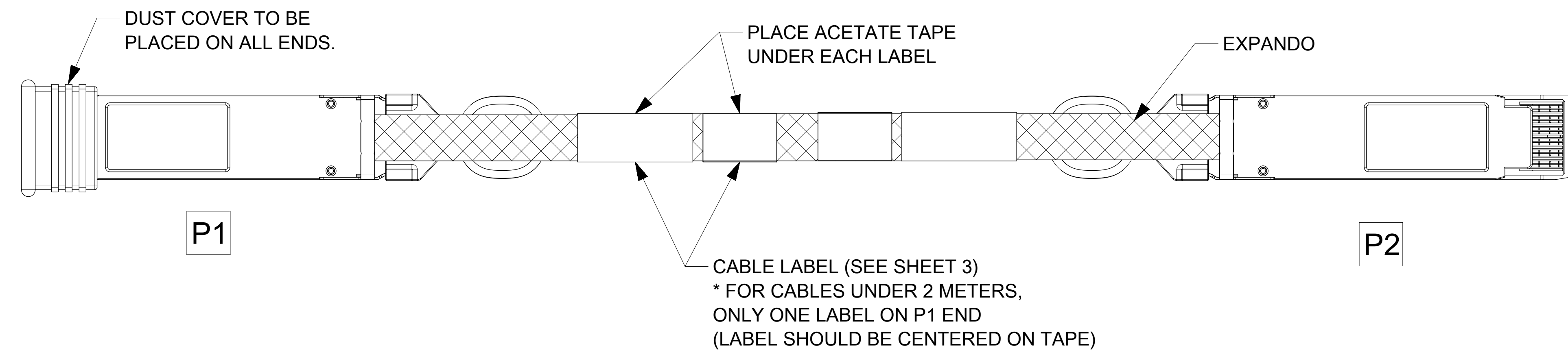

- NOTES:**
- CABLE LENGTH DEPENDS ON WIRE GAUGE, DATA RATE, AND HOST BOARD DRIVER CAPABILITIES
  - MATERIALS:**
    - BACKSHELLS - ZINC DIE CAST WITH BRIGHT NICKEL PLATING
    - DELATCH - STAINLESS STEEL WITH OVERMOLDED NYLON
    - RIVETS - STAINLESS STEEL
  - IMPEDANCE - 100 OHMS DIFFERENTIAL
  - BUNDLED CABLE RATED UL VW-1 FLAME PER UL STYLE 21479
  - EEPROM MAP AVAILABLE UPON REQUEST
  - RoHS COMPLIANT, NO EXEMPTIONS

FUNCTIONAL SYMBOLS $F_A = 0$ $F_C = 0$ $F_P = 0$ DIVISIONAL SYMBOLS	DIMENSION UNITS: <b>mm</b> SCALE: <b>2:1</b>		CURRENT REV DESC: SHEET4 : ADDED LENGTH 2M 30AWG IN P/N TABLE							
	GENERAL TOLERANCES (UNLESS SPECIFIED)		EC NO: 677116 DRWN: ADITHK 2021/05/24 CHK'D: VITTAD 2021/09/09 APPR: MGARRISON 2021/09/10					QSF-P-DD TO QSF-P-DD 56G PASSIVE CABLE ASY		
	ANGULAR TOL $\pm 5.0^\circ$		INITIAL REVISION: DRWN: TPRATT 2016/11/08 APPR: CHIRSCHY 2016/11/10		PRODUCT CUSTOMER DRAWING					
	4 PLACES $\pm$ 3 PLACES $\pm$ 2 PLACES $\pm 0.13$ 1 PLACE $\pm 0.25$ 0 PLACES $\pm$		DRAFT WHERE APPLICABLE MUST REMAIN WITHIN DIMENSIONS		THIRD ANGLE PROJECTION		DRAWING: <b>D-SIZE</b>	SERIES: <b>201591</b>	MATERIAL NUMBER: <b>SEE P/N TABLE</b>	CUSTOMER: <b>GENERAL MARKET</b>

# CABLE BEND RADIUS

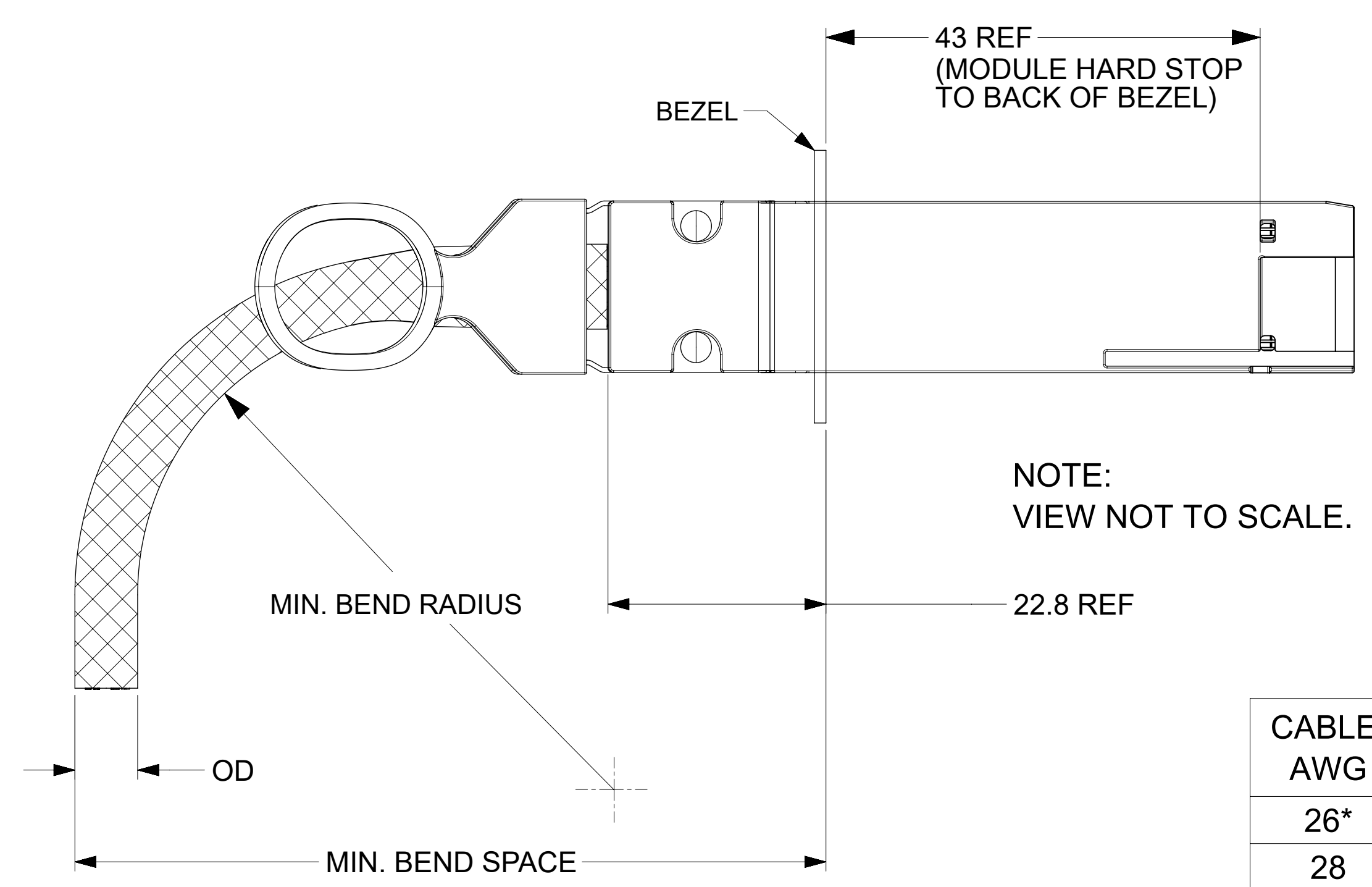

NOTE:  
VIEW NOT TO SCALE.

CABLE AWG	OD (mm)	MIN BEND RADIUS (mm)	MIN BEND SPACE (mm)
26*	(13)	(65)	(101)
28	(11)	(55)	(89)
30	(9.4)	(45)	(77)

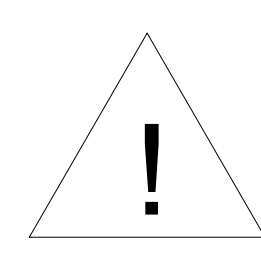

\*MINIMUM BEND RADIUS PENDING QUALIFICATION. NUMBERS ABOVE ARE ESTIMATES AND SUBJECT TO CHANGE.

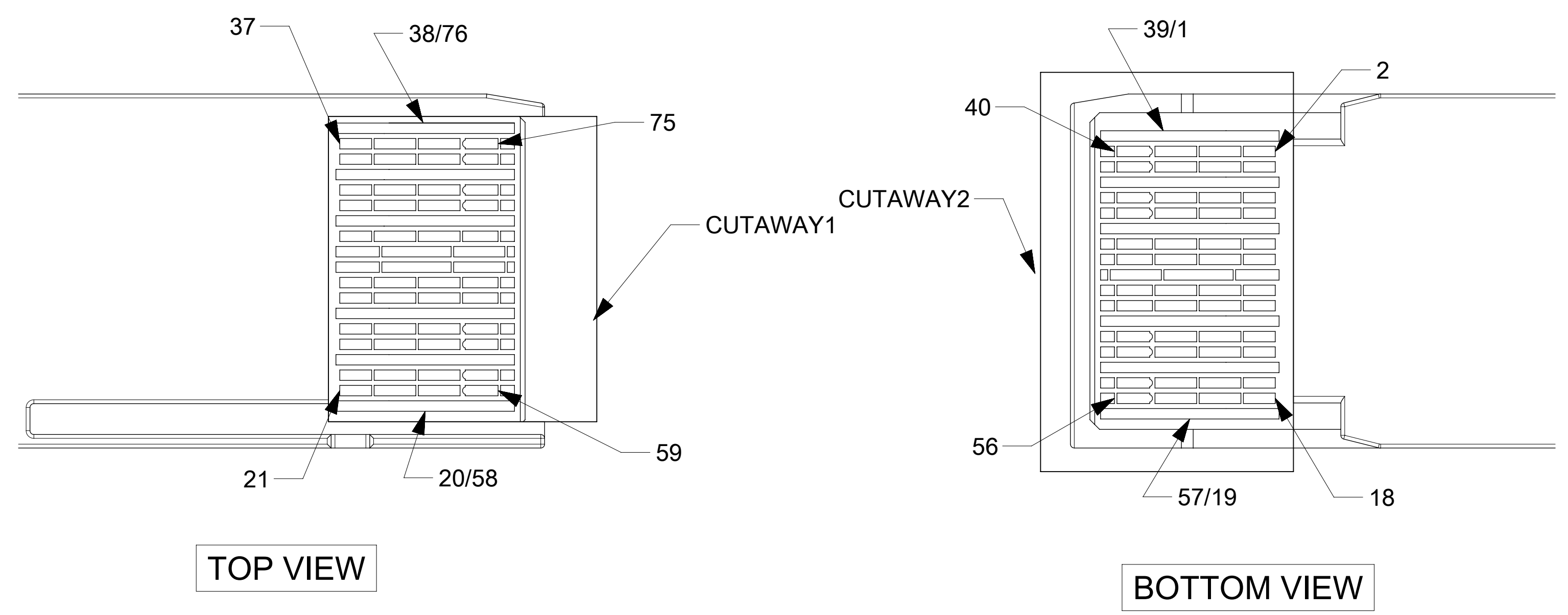

- NOTES:
- DC BLOCKING CAPS ON RECEIVE SIDE ONLY
  - CABLE COILED AND PACKAGED IN BEST FIT ESD BAG AND SEALED WITH ESD LABEL FOR SHIPPING

<b>FUNCTIONAL SYMBOLS</b> $F_A = 0$ $F_C = 0$ $F_P = 0$	DIMENSION UNITS: <b>mm</b> SCALE: <b>20:1</b>		CURRENT REV DESC: SHEET4 : ADDED LENGTH 2M 30AWG IN P/N TABLE			
	GENERAL TOLERANCES (UNLESS SPECIFIED)		EC NO: 677116 DRWN: ADITHK 2021/05/24 CHK'D: VITTAD 2021/09/09 APPR: MGARRISON 2021/09/10			PRODUCT CUSTOMER DRAWING
	ANGULAR TOL $\pm 5.0^\circ$		INITIAL REVISION: DRWN: TPRATT 2016/11/08 APPR: CHIRSCHY 2016/11/10			DOCUMENT NUMBER: <b>2015911005</b> DOC TYPE: PSD DOC PART: 000 REVISION: U
	DRAFT WHERE APPLICABLE MUST REMAIN WITHIN DIMENSIONS		THIRD ANGLE PROJECTION	DRAWING: <b>D-SIZE</b> SERIES: <b>201591</b>		MATERIAL NUMBER: SEE P/N TABLE CUSTOMER: GENERAL MARKET SHEET NUMBER: 2 OF 4

# WIRING DIAGRAM

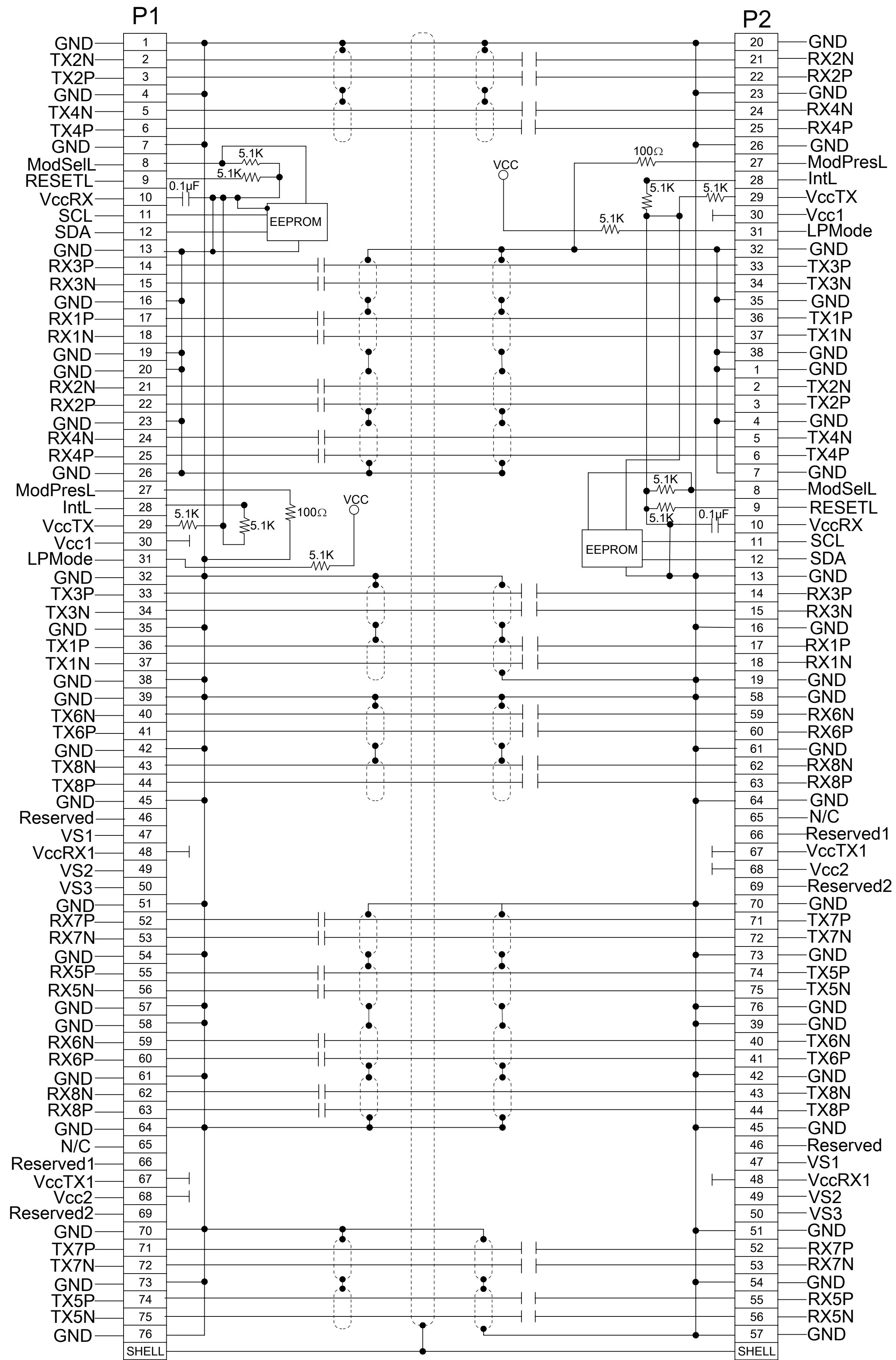

FUNCTIONAL SYMBOLS $\nabla_A = 0$ $\nabla_C = 0$ $\nabla_P = 0$	DIMENSION UNITS <b>mm</b>	SCALE <b>1:1</b>	CURRENT REV DESC: SHEET4 : ADDED LENGTH 2M 30AWG IN P/N TABLE					
	GENERAL TOLERANCES (UNLESS SPECIFIED)			<div style="font-size: 24px; font-weight: bold; margin-bottom: 10px;">molex</div> QSFP-DD TO QSFP-DD 56G PASSIVE CABLE ASY				
ANGULAR TOL $\pm 5.0^\circ$			EC NO: 677116 DRWN: ADITHK 2021/05/24 CHK'D: VITTAD 2021/09/09 APPR: MGARRISON 2021/09/10					
4 PLACES $\pm$								
3 PLACES $\pm$								
2 PLACES $\pm 0.13$								
1 PLACE $\pm 0.25$			INITIAL REVISION: DRWN: TPRATT 2016/11/08 APPR: CHIRSCHY 2016/11/10					
0 PLACES $\pm$			DOCUMENT NUMBER <div style="font-size: 18px; font-weight: bold;">2015911005</div>					
DRAFT WHERE APPLICABLE MUST REMAIN WITHIN DIMENSIONS			THIRD ANGLE PROJECTION 	DRAWING <div style="font-size: 14px; font-weight: bold;">D-SIZE</div>	SERIES <div style="font-size: 14px; font-weight: bold;">201591</div>	MATERIAL NUMBER SEE P/N TABLE	CUSTOMER GENERAL MARKET	SHEET NUMBER 3 OF 4

**LABEL DETAILS**

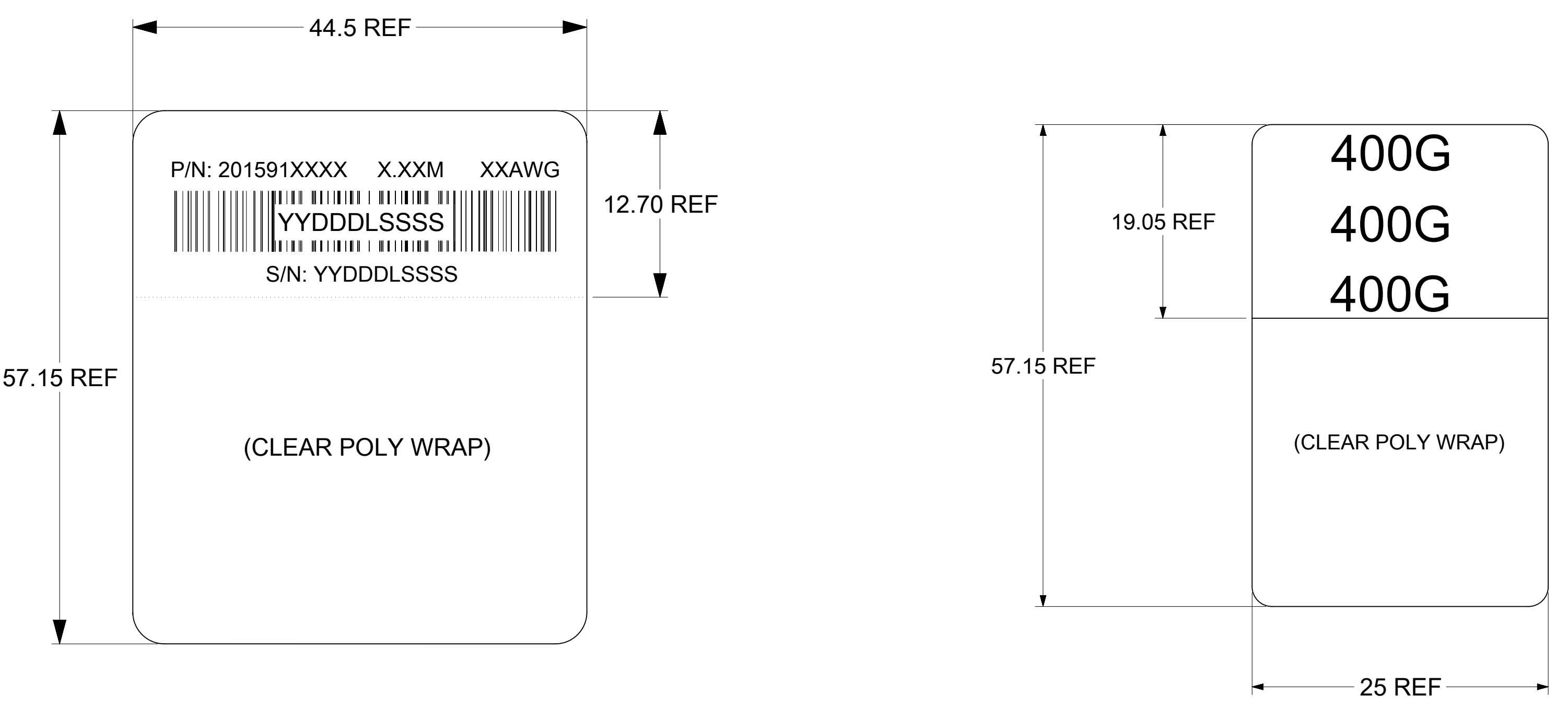

P/N: 201591XXXX - MOLEX PART NUMBER (SEE P/N TABLE)

X.XXM - CABLE LENGTH IN METERS (EXAMPLES - 0.5M, 1.0M, 1.5M)  
SEE P/N TABLE FOR THE NUMBER OF DIGITS

XXAWG - CABLE SIZE IN AWG

S/N: YYDDLSSSS - SERIAL NUMBER  
 YY = YEAR, THE LAST 2 DIGITS OF YEAR  
 DDD = DAY OF THE YEAR  
 L = LOCATION  
 1 - USA  
 2 - MEXICO  
 3 - CHINA  
 4 - PHILIPPINES  
 SSSS = SERIAL NUMBER (0001-9999)

MOLEX P/N	LENGTH (M)	AWG
2015911005*	0.5M +/- 0.05M	30
2015911007	0.75M +/- 0.05M	30
2015911010	1.0M +/- 0.05M	30
2015911012	1.25M +/- 0.05M	30
2015911015	1.5M +/- 0.08M	30
2015911020	2.0M +/- 0.08M	30
2015913005*	0.5M +/- 0.05M	28
2015913010	1.0M +/- 0.05M	28
2015913012	1.25M +/- 0.05M	28
2015913015	1.5M +/- 0.08M	28
2015913017	1.75M +/- 0.08M	28
2015913020	2.0M +/- 0.08M	28
2015913025	2.5M +/- 0.08M	28
2015913252	2.5M +/- 0.08M	26
2015913027	2.75M +/- 0.08M	26
2015913030	3.0M +/- 0.08M	26

\*CABLES MAY NOT MEET ALL IEEE 802.3cd 56G PAM4 PARAMETERS

FUNCTIONAL SYMBOLS FA = 0 FE = 0 FP = 0 DIVISIONAL SYMBOLS	THIS DRAWING CONTAINS INFORMATION THAT IS PROPRIETARY TO MOLEX ELECTRONIC TECHNOLOGIES, LLC AND SHOULD NOT BE USED WITHOUT WRITTEN PERMISSION		DIMENSION UNITS: <b>mm</b> SCALE: <b>1:1</b>		CURRENT REV DESC: SHEET4 : ADDED LENGTH 2M 30AWG IN P/N TABLE					
	GENERAL TOLERANCES (UNLESS SPECIFIED) ANGULAR TOL ± 5.0°		4 PLACES ± 3 PLACES ± 2 PLACES ± 0.13 1 PLACE ± 0.25 0 PLACES ±		EC NO: 677116 DRWN: ADITHK 2021/05/24 CHK'D: VITTAD 2021/09/09 APPR: MGARRISON 2021/09/10					
	DRAFT WHERE APPLICABLE MUST REMAIN WITHIN DIMENSIONS		THIRD ANGLE PROJECTION		DRWING: TPRATT 2016/11/08 APPR: CHIRSCHY 2016/11/10		PRODUCT CUSTOMER DRAWING			
	DOCUMENT STATUS: P1 RELEASE DATE: 2021/09/10 01:01:00		D-D-SIZE SERIES: 201591		MATERIAL NUMBER: SEE P/N TABLE CUSTOMER: GENERAL MARKET		DOCUMENT NUMBER: 2015911005 DOC TYPE: PSD DOC PART: 000 REVISION: U SHEET NUMBER: 4 OF 4			