

NOTES

- ① 材料及び仕上げ(めっき仕様) : TABLE1参照
MATERIAL AND FINISH : SEE TABLE 1
- 2.製品仕様書 : 2122090000-PS PS 000
PRODUCTS SPECIFICATION : 2122090000-PS PS 000
- 3.梱包仕様書 : 2122109200-SPK PS 200
PACKAGING SPECIFICATION : 2122109200-SPK PS 200
- ④ 嵌合相手 : 212209シリーズ
MATE WITH : 212209SERIES
- 5.アプリケーション仕様書(コネクタ取扱い説明書) : 2166940000-AS PS 000
APPLICATION SPECIFICATION(CONNECTOR MANUAL) : 2166940000-AS PS 000
- ⑥ 発注番号 : SHEET 2参照
ORDER No.:PLEASE REFER TO SHEET 2 FOR PRODUCT LIST

212210

0***

極数
CIRCUIT SIZE

ハウジングカラー HOUSING COLOR
0:ナチュラル NATURAL
1:黒 BLACK
2:赤 RED
3:黄 YELLOW

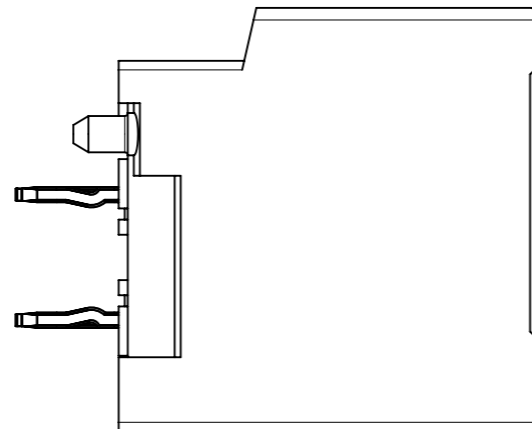
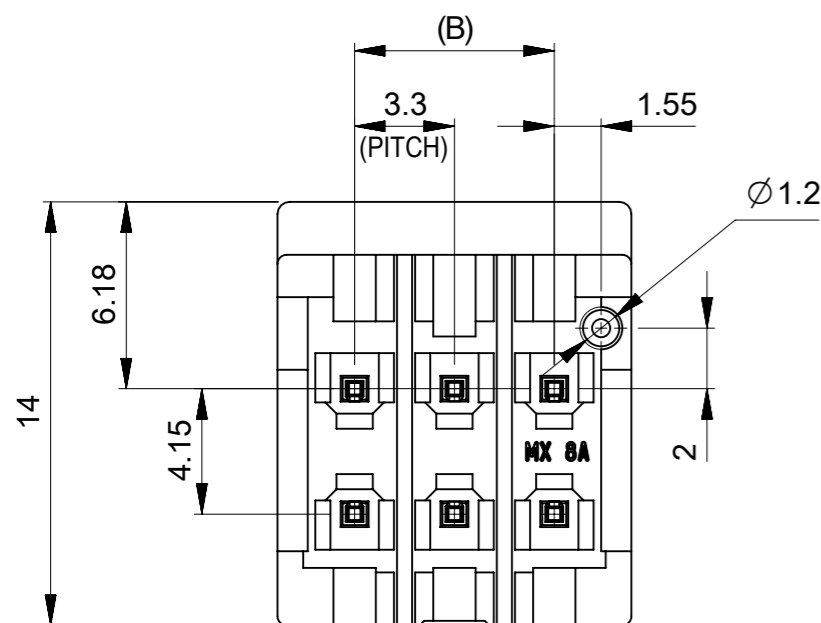

CIRCUIT 1

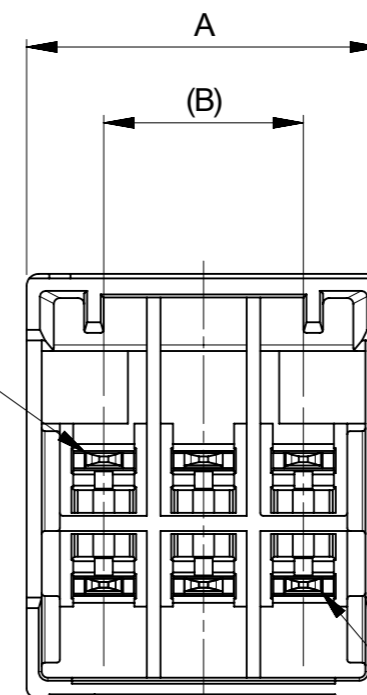

CIRCUIT N

① TABLE1

6.6	11.7	6
3.3	8.4	4
-	6.6	2
B	A	極数 CIRCUIT SIZE

番号 No.	部品 PART	材質 MATERIAL
①	ハウジング HOUSING	ポリアミド(PA), UL94 V-0, ガラス含有, 色:SEE CHART POLYAMIDE(PA), UL94 V-0, GLASS FILED, COLOR : SEE CHART
②	ピン PIN	MATERIAL 銅合金 COPPER ALLOY
		下地めっき UNDER PLATING ニッケルめっき(下地):1.0 micro-metter MIN. NICKEL (UNDER PLATING)
		接点部 CONTACT 錫めっき : 1.0 micro-meter MIN. MATTE TIN PLATING
		テール TAIL 錫めっき : 1.0 micro-meter MIN. MATTE TIN PLATING

THIS DRAWING CONTAINS INFORMATION THAT IS PROPRIETARY TO MOLEX ELECTRONIC TECHNOLOGIES, LLC AND SHOULD NOT BE USED WITHOUT WRITTEN PERMISSION		CURRENT REV DESC:		molex	
DIMENSION UNITS mm	SCALE NTS	EC NO: 649906			
GENERAL TOLERANCES (UNLESS SPECIFIED)		DRWN: HKOBAYASHI 2020/07/02		CP-3.3 W/B HEADER ASSEMBLY DR ST DIP	
ANGULAR TOL ± 3.0°		CHK'D: AIDA 2020/11/25		PRODUCT CUSTOMER DRAWING	
4 PLACES ± 0.2		APPR: KOMURAKAMI 2020/11/25		DOCUMENT NUMBER	
3 PLACES ± 0.2		INITIAL REVISION:		2122100000-SD	
2 PLACES ± 0.2		DRWN: HKOBAYASHI 2020/07/02		DOC TYPE DOC PART REVISION	
1 PLACE ± 0.2		APPR: KOMURAKAMI 2020/11/25		PSD 000 A	
0 PLACES ± 0.2		DRAFT WHERE APPLICABLE MUST REMAIN WITHIN DIMENSIONS		MATERIAL NUMBER CUSTOMER SHEET NUMBER	
THIRD ANGLE PROJECTION		DRAWING SERIES		SEE CHART GENERAL 1 OF 2	

10

9

8

7

6

5

4

3

2

1

嵌合相手適合リテーナー:212213シリーズ
APPLICABLE RETAINER FOR HOUSING
212213SERIES

嵌合相手 : 212209 シリーズ
MATE WITH :212209SERIES

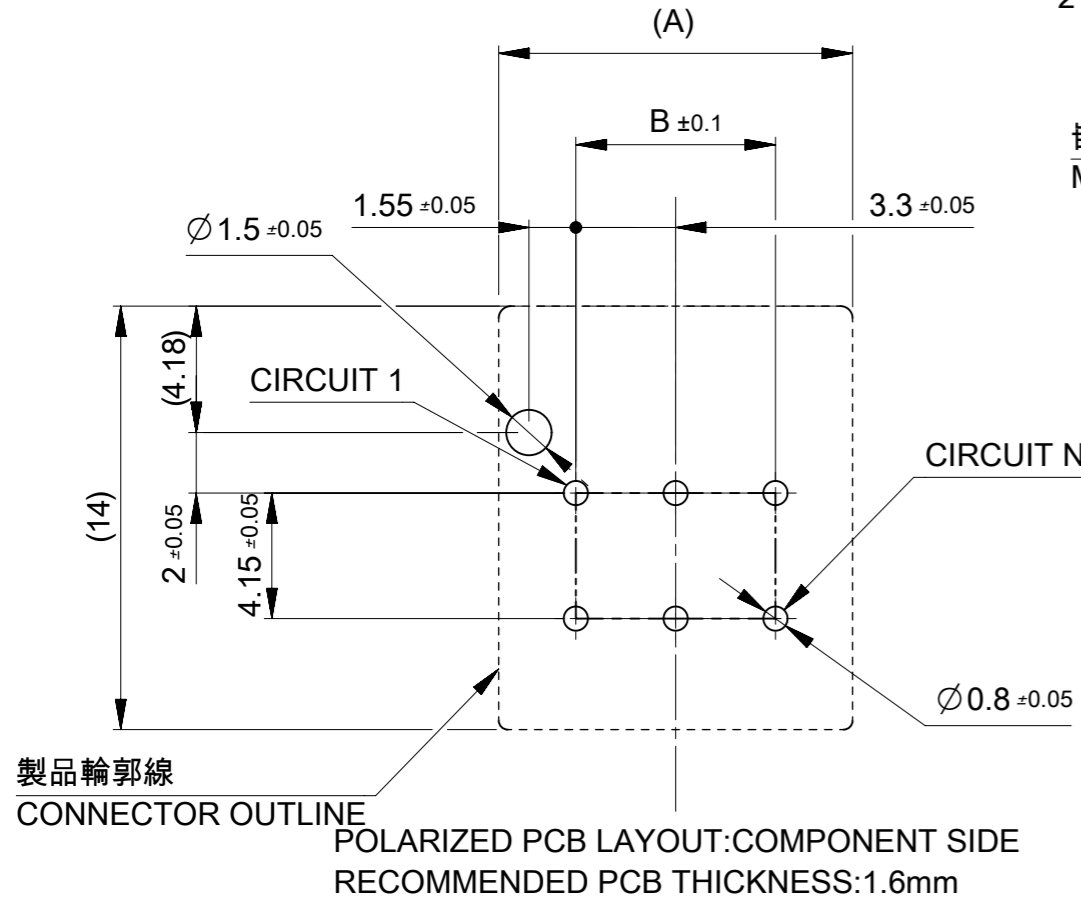

製品レイアウト
PRODUCT LAYOUT

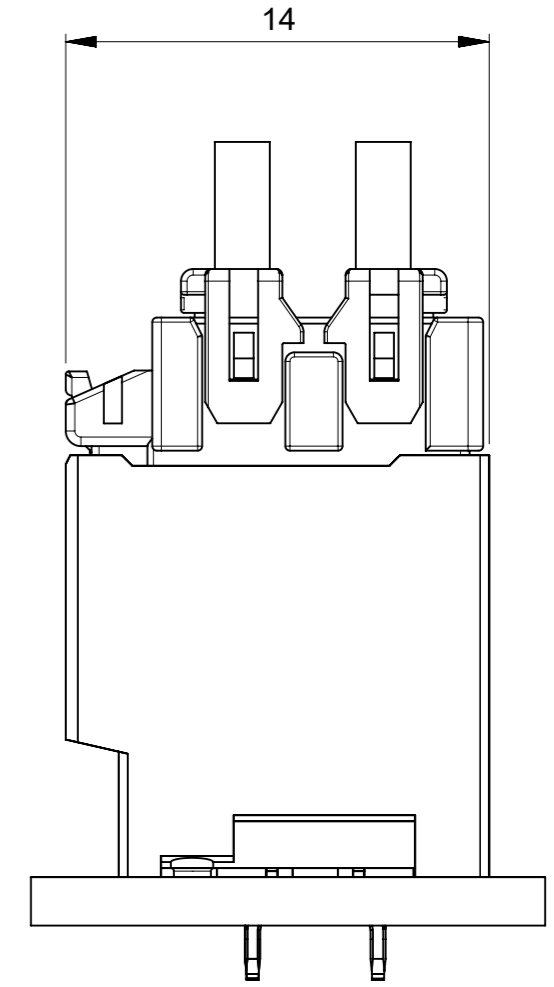
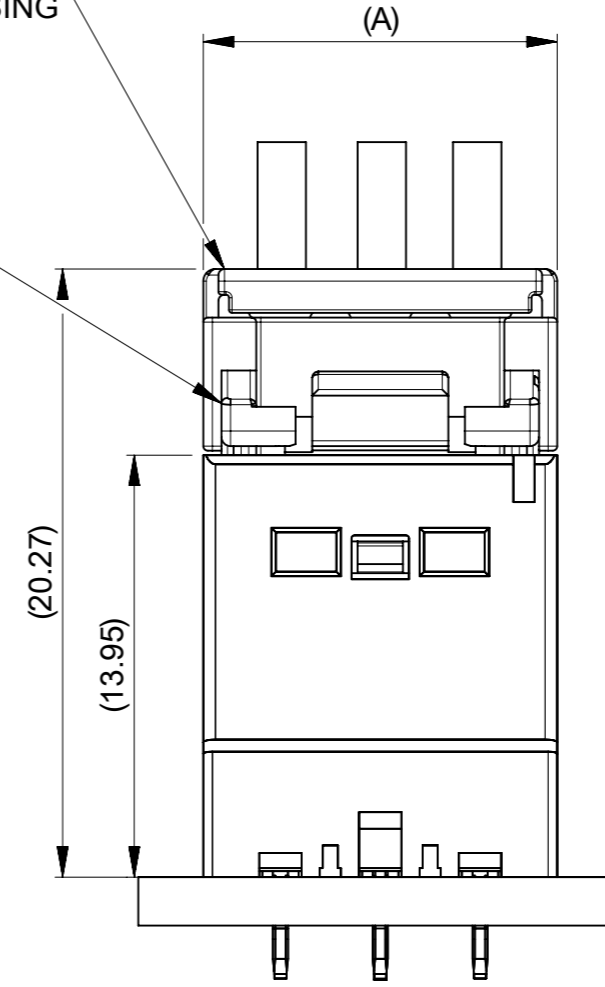

△ 4 嵌合図
MATED CONNECTOR

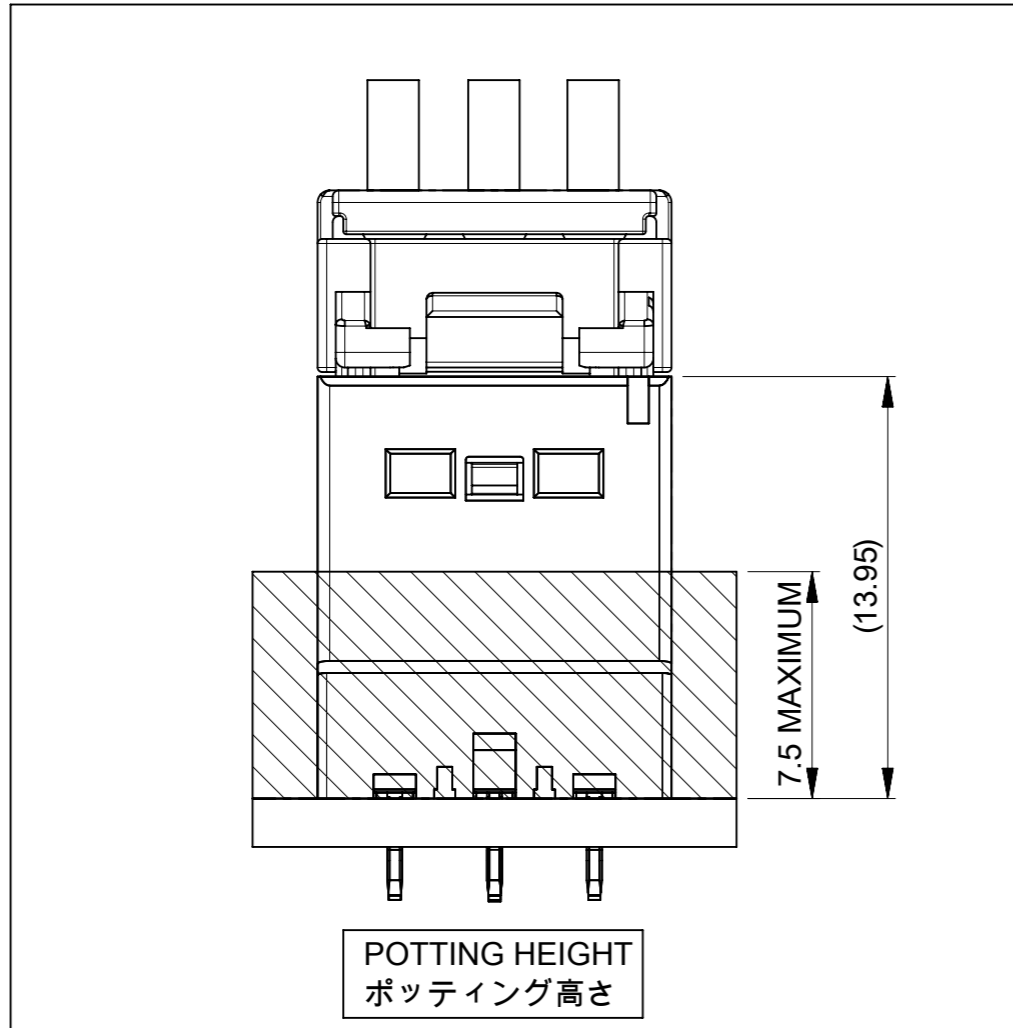

△ 6 PRODUCT LIST

YELLOW	RED	BLACK	NATURAL (WHITE)	HOUSING COLOR
2122100063	2122100062	2122100061	2122100060	6
2122100043	2122100042	2122100041	2122100040	4
2122100023	2122100022	2122100021	2122100020	2
発注番号 ORDER No.				極数 CIRCUIT SIZE
梱包形態 : トレイ PACKAGE : TRAY				

THIS DRAWING CONTAINS INFORMATION THAT IS PROPRIETARY TO MOLEX ELECTRONIC TECHNOLOGIES, LLC AND SHOULD NOT BE USED WITHOUT WRITTEN PERMISSION									
DIMENSION UNITS mm		SCALE NTS		CURRENT REV DESC:					
GENERAL TOLERANCES (UNLESS SPECIFIED)				<p>molex</p> <p>CP-3.3 W/B HEADER ASSEMBLY DR ST DIP</p> <p>PRODUCT CUSTOMER DRAWING</p>					
ANGULAR TOL ± 3.0 °		4 PLACES ± 0.2							
3 PLACES ± 0.2		2 PLACES ± 0.2		DRWN: HKOBAYASHI		2020/11/25		DOC TYPE	
1 PLACE ± 0.2		0 PLACES ± 0.2		CHK'D: AIDA		2020/11/25		DOC PART	
DRAFT WHERE APPLICABLE MUST REMAIN WITHIN DIMENSIONS		THIRD ANGLE PROJECTION		APPR: KOMURAKAMI		2020/11/25		REVISION	
DRAWING		SERIES		MATERIAL NUMBER		CUSTOMER		SHEET NUMBER	
A3-SIZE		212210		SEE CHART		GENERAL		2 OF 2	

9

8

7

6

5

4

3

2

1