

2CCT RECEPTACLE CONNECTOR

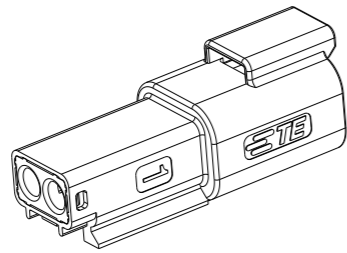

DATE CODE: X XX XX
 X- DAY: 1- 7
 XX- WEEK: 01 - 52
 XX- YEAR: 00 - 99

#- MACHINE NO. 1

EXAMPLE: 11315 = DAY 1, WEEK 13, YEAR 15
 i.e. 23rd OF MARCH 2015

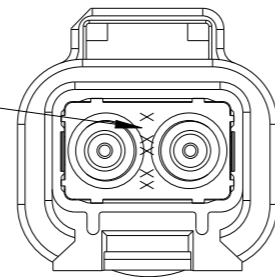

DETAIL B
 SCALE 2:1

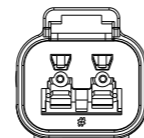
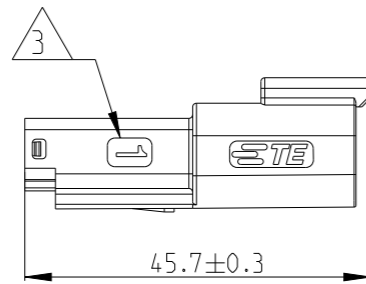
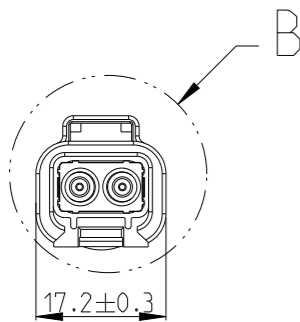

1. THIS RECEPT MATES WITH PLUG ASSEMBLY PN X-2600023-X, WEDGE LOCK PN W2PX.

2. MATERIAL
 RECEPT HOUSING: NYLON GF30
 BACK SEAL: SILICONE RUBBER
 BACK COVER: NYLON GF30, BLACK
 HEATSHRINK HOUSING: NYLON GF30, BLACK

3 CIRCUIT IDENTIFICATION

4. JACKET RANGE LARGE = 2.23mm - 3.68mm (SEAL COLOUR: GREEN)
 JACKET RANGE SMALL = 1.20mm - 3.05mm (SEAL COLOUR: BURNT ORANGE)

DIMENSIONS:
 mm

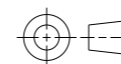

TOLERANCES UNLESS OTHERWISE SPECIFIED:

0 PLC	±
1 PLC	±
2 PLC	±
3 PLC	±
4 PLC	±
ANGLES	±

MATERIAL

FINISH

-
 -

-
 -

THIS DRAWING IS A CONTROLLED DOCUMENT.

DWN J.SHANG 16 JUN 2020

CHK E.JIANG 16 JUN 2020

APVD L.YIN 16 JUN 2020

PRODUCT SPEC 108-160026

APPLICATION SPEC 114-160017

WEIGHT -

CUSTOMER DRAWING

REVISIONS

P	LTR	DESCRIPTION	DATE	DWN	APVD
	A	INITIAL RELEASE	16 JUN 2020	J.S	I.Y
	A1	ECR-20-010349	24 JUL 2020	J.G	I.Y
	A2	ECN-21-113425	17 AUG 2021	J.G	Z.Z

2CCT RECEPTACLE CONNECTOR WITH HEATSHRINK HOUSING ULTRASONICALLY WELDED IN PLACE

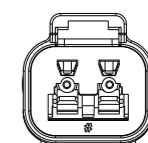
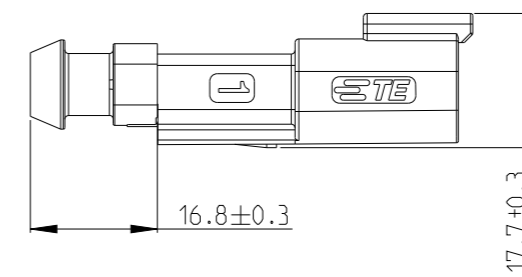
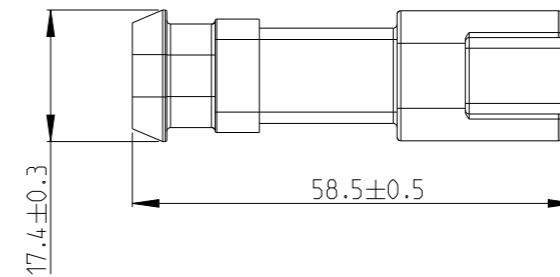
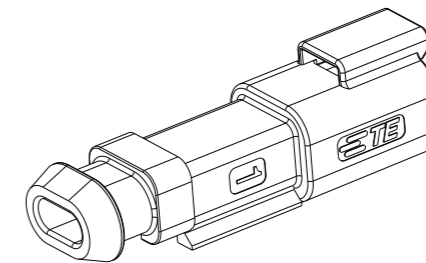

NAME 2CCT DT-XT RECEPTACLE CONNECTOR

SIZE A3 CAGE CODE 00779 DRAWING NO C-2600022 RESTRICTED TO

SCALE 1:1 SHEET 1 OF 2 REV A2

