

Power management (dual transistors)

EMF22 / UMF22N

2SC5585 and DTC114E are housed independently in a EMT6 or UMT6 package.

●Application

Power management circuit

●Features

- 1) Power switching circuit in a single package.
- 2) Mounting cost and area can be cut in half.

●Structure

Silicon epitaxial planar transistor

●Equivalent circuits

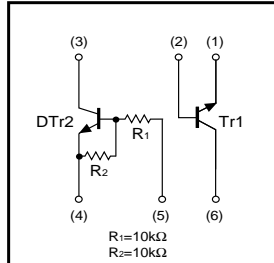

●External dimensions (Units : mm)

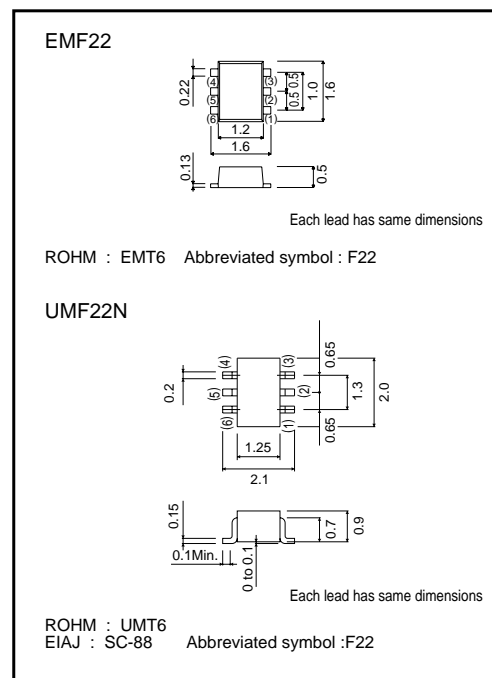

●Packaging specifications

Type	EMF22	UMF22N
Package	EMT6	UMT6
Marking	F22	F22
Code	T2R	TR
Basic ordering unit(pieces)	8000	3000

Transistors

●Absolute maximum ratings (Ta=25°C)

Tr1

Parameter	Symbol	Limits	Unit
Collector-base voltage	V _{CB0}	15	V
Collector-emitter voltage	V _{CE0}	12	V
Emitter-base voltage	V _{EB0}	6	V
Collector current	I _c	500	mA
	I _{cP}	1.0	A *1
Power dissipation	P _c	150(TOTAL)	mW *2
Junction temperature	T _j	150	°C
Range of storage temperature	T _{stg}	-55~+150	°C

*1 Single pulse P_w=1ms

*2 120mW per element must not be exceeded.

Each terminal mounted on a recommended land.

DTr2

Parameter	Symbol	Limits	Unit
Supply voltage	V _{CC}	50	V
Input voltage	V _{IN}	-10~+40	V
Collector current	I _c	100	mA *1
Output current	I _o	50	mA
Power dissipation	P _c	150(TOTAL)	mW *2
Junction temperature	T _j	150	°C
Range of storage temperature	T _{stg}	-55~+150	°C

*1 Characteristics of built-in transistor.

*2 120mW per element must not be exceeded.

Each terminal mounted on a recommended land.

●Electrical characteristics (Ta=25°C)

Tr1

Parameter	Symbol	Min.	Typ.	Max.	Unit	Conditions
Collector-emitter breakdown voltage	BV _{CE0}	12	-	-	V	I _c =1mA
Collector-base breakdown voltage	BV _{CB0}	15	-	-	V	I _c =10μA
Emitter-base breakdown voltage	BV _{EB0}	6	-	-	V	I _E =10μA
Collector cut-off current	I _{cBO}	-	-	100	nA	V _{CB} =15V
Emitter cut-off current	I _{EBO}	-	-	100	nA	V _{EB} =6V
Collector-emitter saturation voltage	V _{CE(sat)}	-	90	250	mV	I _c =200mA, I _B =10mA
DC current gain	h _{FE}	270	-	680	-	V _{CE} =2V, I _c =10mA
Transition frequency	f _T	-	320	-	MHz	V _{CE} =2V, I _E =-10mA, f=100MHz
Collector output capacitance	C _{ob}	-	7.5	-	pF	V _{CB} =10V, I _E =0mA, f=1MHz

DTr2

Parameter	Symbol	Min.	Typ.	Max.	Unit	Conditions
Input voltage	V _{I(off)}	-	-	0.5	V	V _{CC} =5V, I _o =100μA
	V _{I(on)}	3	-	-		V _o =0.3V, I _o =10mA
Output voltage	V _{O(on)}	-	0.1	0.3	V	I _o /I _I =10mA/0.5mA
Input current	I _I	-	-	0.88	mA	V _I =5V
Output current	I _{O(off)}	-	-	0.5	μA	V _{CC} =50V, V _I =0V
DC current gain	G _I	30	-	-	-	V _o =5V, I _o =5mA
Input resistance	R ₁	7	10	13	kΩ	-
Resistance ratio	R ₂ /R ₁	0.8	1	1.2	-	-
Transition frequency	f _T	-	250	-	MHz	V _{CE} =10V, I _E =-5mA, f=100MHz *

*Transition frequency of the device

Transistors

●Electrical characteristic curves

Tr1

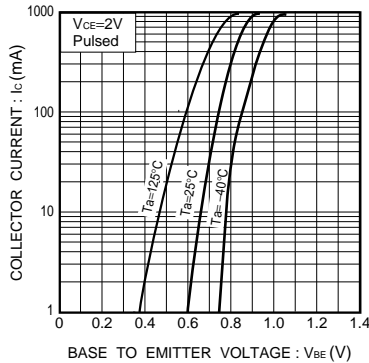

Fig.1 Grounded emitter propagation characteristics

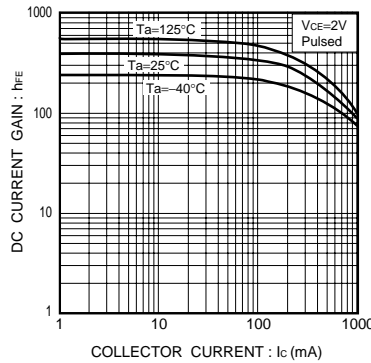

Fig.2 DC current gain vs. collector current

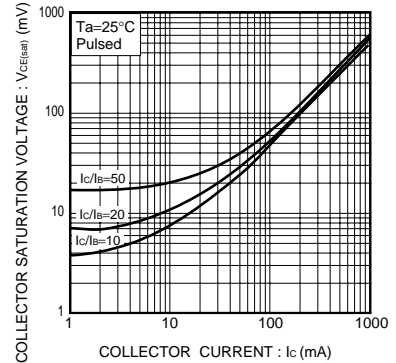

Fig.3 Collector-emitter saturation voltage vs. collector current (I)

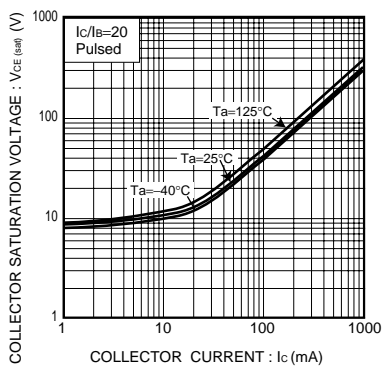

Fig.4 Collector-emitter saturation voltage vs. collector current (II)

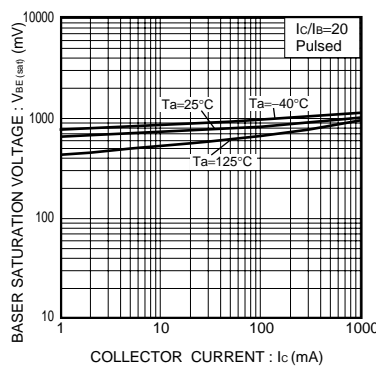

Fig.5 Base-emitter saturation voltage vs. collector current

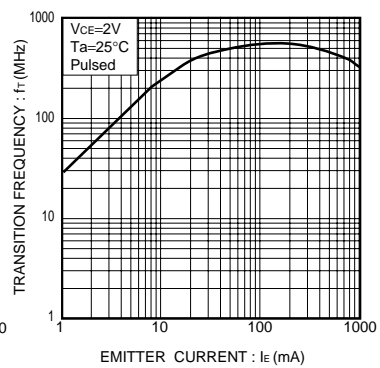

Fig.6 Gain bandwidth product vs. emitter current

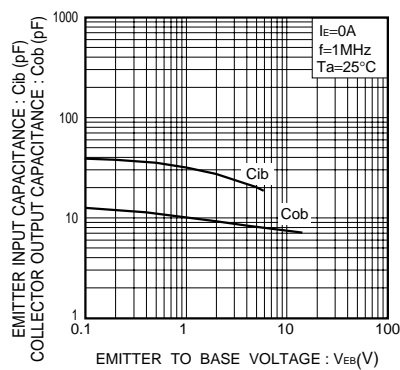

Fig.7 Collector output capacitance vs. collector-base voltage
Emitter input capacitance vs. emitter-base voltage

Transistors

DTr2

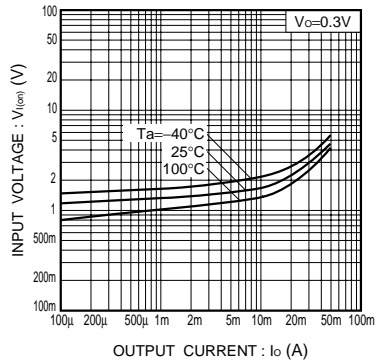

Fig.1 Input voltage vs. output current (ON characteristics)

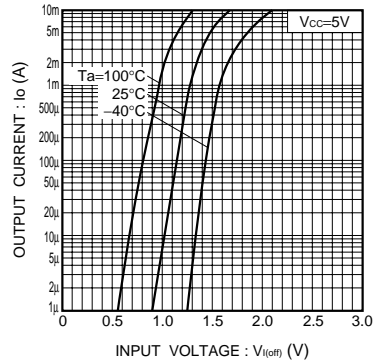

Fig.2 Output current vs. input voltage (OFF characteristics)

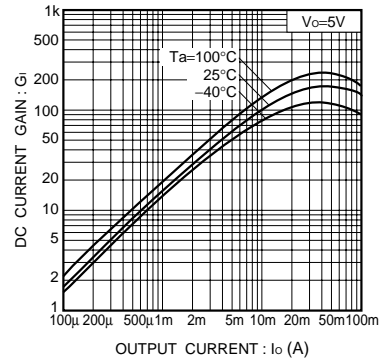

Fig.3 DC current gain vs. output current

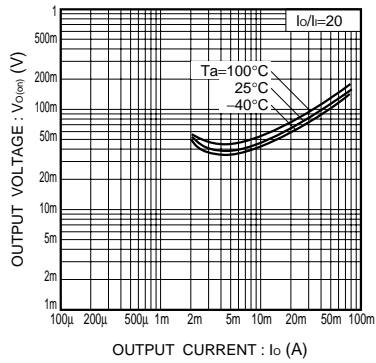

Fig.4 Output voltage vs. output current