

NU SERIES

1W~2W UNREGULATED

DANUBE

FEATURES

- UP TO 1W~2W UNREGULATED OUTPUT POWER
- 100% BURN IN
- HIGH EFFICIENCY
- SMD TECHNOLOGY
- LOW COST
- UL 94V-0 PACKAGE MATERIAL
- CUSTOM SOLUTIONS AVAILABLE
- MTBF>2,000,000 HOURS
- RoHS COMPLIANT
- 2 YEARS WARRANTY

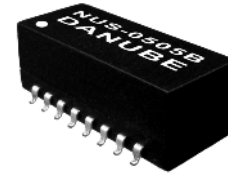

OUTPUT SPECIFICATIONS

Voltage Set-point Accuracy	+/-2% max
Temperature Coefficient	+/-0.03%/°C
Ripple & Noise(20MHz BW) ¹	100mVp-p max
Line Regulation ²	+/-1.2% max
Line Regulation ³	+/-1.5% max
Load Regulation ⁴	+/-8% max
Load Regulation ⁵	+/-12% max
Minimum Load	10% of Full Load
Short Circuit Protection	Momentary

ENVIRONMENTAL SPECIFICATIONS

Operating Temperature	-40 °C to +71 °C
Storage Temperature	-55 °C to +125 °C
Humidity	95% max
Cooling	Free-Air Convection

INPUT SPECIFICATIONS

Input Voltage Range	+/-10% max
Input Filter	Capacitor Type
Protection	Fuse Recommended

GENERAL SPECIFICATIONS

Efficiency	70%-79%
Isolation Voltage ⁶	1000 VDC min
Isolation Resistance	10 ⁹ ohms min
Isolation Capacitance	80pF max
Switching Frequency	100KHz Typ
MTBF ⁷	>2,000,000 Hours
Weight	3g Typ
Case Material	Non-Conductive Plastic
Case Size A	13.8mm*12.8mm*9.3mm
B	25.4mm*12.8mm*9.3mm
Conducted Emissions	EN55022 Class A
Radiated Emissions	EN55022 Class A

ALL SPECIFICATIONS TYPICAL AT NOMINAL LINE, FULL LOAD, AND 25 °C UNLESS OTHERWISE NOTED.

¹ Measured with 1uF ceramic capacitor connect to the output pins.

² Line Regulation is for a 1% change in input voltage.

³ Line Regulation is for a 1% change in input voltage when input voltage is 3V and 3.3V.

⁴ Load Regulation is for output load current change from 20% to 100%.

⁵ Load Regulation is for output load current change from 20% to 100% when input voltage is 3V and 3.3V.

⁶ For 10 seconds.

⁷ MIL-HDBK-217F@25 °C, Ground Benign.

● **SELECTION GUIDE(1)**
0.25W~0.5W 1000VDC ISOLATION

MODEL NUMBER	INPUT VOLTAGE (VDC)	OUTPUT VOLTAGE (VDC)	OUTPUT CURRENT (mA)	INPUT ⁸ CURRENT(mA)		EFF (%) ⁹	ISOLATION (VDC)	PACKAGE
				FULL LOAD	NO LOAD			
				NUS-03.305A-0.25W	3.3			

Note: Other input to output voltages may be available. Please contact factory.

● **SELECTION GUIDE(2)**
1W 1000VDC ISOLATION

MODEL NUMBER	INPUT VOLTAGE (VDC)	OUTPUT VOLTAGE (VDC)	OUTPUT CURRENT (mA)	INPUT ¹⁰ CURRENT(mA)		EFF (%) ¹¹	ISOLATION (VDC)	PACKAGE
				FULL LOAD	NO LOAD			
				NUS-03.303.3A	3.3			
NUS-0505A	5	5	200	283	35	71	1000	A
NUS-0509A	5	9	111	257	25	78	1000	A
NUS-0512A	5	12	84	257	25	78	1000	A
NUS-0515A	5	15	67	253	28	79	1000	A
NUS-1205A	12	5	200	112	14	74	1000	A
NUS-1209A	12	9	111	107	11	78	1000	A
NUS-1212A	12	12	84	102	10	82	1000	A
NUS-1215A	12	15	67	102	12	82	1000	A
NUS-2405A-0.75W	24	5	150	41	11	76	1000	A
NUS-2405A	24	5	200	54	11	76	1000	A

Note: Other input to output voltages may be available. Please contact factory.

⁸ NOMINAL INPUT VOLTAGE.

⁹ NOMINAL INPUT VOLTAGE, FULL LOAD.

¹⁰ NOMINAL INPUT VOLTAGE.

¹¹ NOMINAL INPUT VOLTAGE, FULL LOAD.

● **SELECTION GUIDE(3)**
1.8W 1000VDC ISOLATION

MODEL NUMBER	INPUT VOLTAGE (VDC)	OUTPUT VOLTAGE (VDC)	OUTPUT CURRENT (mA)	INPUT ¹² CURRENT(mA)		EFF (%) ¹³	ISOLATION (VDC)	PACKAGE
				FULL LOAD	NO LOAD			
				NUS-0505B	5			
NUS-0509B	5	9	200	480	70	75	1000	B
NUS-0512B	5	12	150	467	70	77	1000	B
NUS-0515B	5	15	120	467	70	77	1000	B
NUS-1205B	12	5	360	206	40	73	1000	B
NUS-1209B	12	9	200	197	40	76	1000	B
NUS-1212B	12	12	150	192	40	78	1000	B
NUS-1215B	12	15	120	192	40	78	1000	B

Note: Other input to output voltages may be available. Please contact factory.

● **SELECTION GUIDE(4)**
2W 1000VDC ISOLATION

MODEL NUMBER	INPUT VOLTAGE (VDC)	OUTPUT VOLTAGE (VDC)	OUTPUT CURRENT (mA)	INPUT ¹⁴ CURRENT(mA)		EFF (%) ¹⁵	ISOLATION (VDC)	PACKAGE
				FULL LOAD	NO LOAD			
				NUS-0505B2	5			
NUS-0509B2	5	9	222	506	50	79	1000	B
NUS-0512B2	5	12	167	500	50	80	1000	B
NUS-0515B2	5	15	133	488	50	82	1000	B
NUS-1205B2	12	5	400	214	20	78	1000	B
NUS-1209B2	12	9	222	214	20	78	1000	B
NUS-1212B2	12	12	167	200	20	83	1000	B
NUS-1215B2	12	15	133	196	20	85	1000	B
NUS-2405B2	24	5	400	107	15	78	1000	B
NUS-2409B2	24	9	222	107	15	78	1000	B
NUS-2412B2	24	12	167	104	15	80	1000	B
NUS-2415B2	24	15	133	104	15	80	1000	B

Note: Other input to output voltages may be available. Please contact factory.

¹² NOMINAL INPUT VOLTAGE.

¹³ NOMINAL INPUT VOLTAGE, FULL LOAD.

¹⁴ NOMINAL INPUT VOLTAGE.

¹⁵ NOMINAL INPUT VOLTAGE, FULL LOAD.

MECHANICAL DIMENSIONS & RECOMMENDED FOOTPRINT DETAILS (1)

PACKAGE "A"

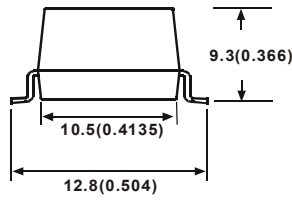
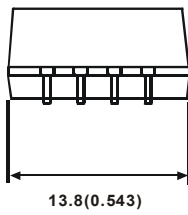
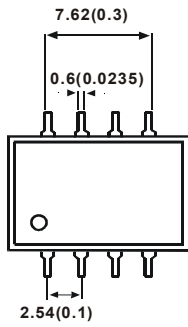

PIN	SINGLE
1	-Vin
2	+Vin
4	-Vout
5	+Vout

NOTE : All Dimensions In mm(Inches)

1. Pin Size is 0.55mx0.30mm[0.022x0.01"]
2. Pin is Tolerance .XX= ±0.07mm
3. Tolerance .X or .XX= ±0.5mm

Unit:mm(inch)+/-0.25(0.010)

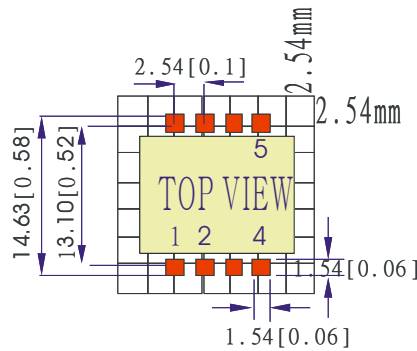

● MECHANICAL DIMENSIONS & RECOMMENDED FOOTPRINT DETAILS (2)

PACKAGE "B"

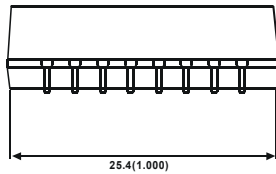
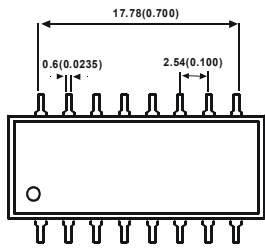

Unit: mm(inch)+/-0.25(0.010)

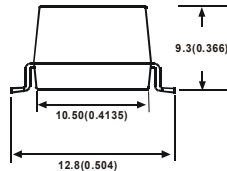

PIN	SINGLE
1	-Vin
3	+Vin
7	+Vout
8	-Vout

NOTE : All Dimensions In mm(Inches)

1. Pin Size is 0.55x0.30mm[0.022x0.01"]

2. Pin is Tolerance .XX= ±0.07mm

3. Tolerance .X or .XX= ±0.5mm

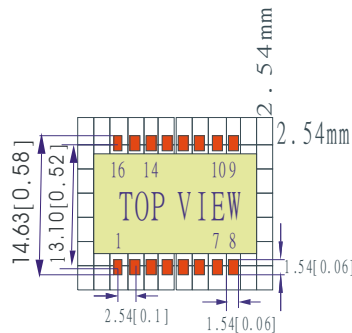

● REFLOW SOLDERING CURVE

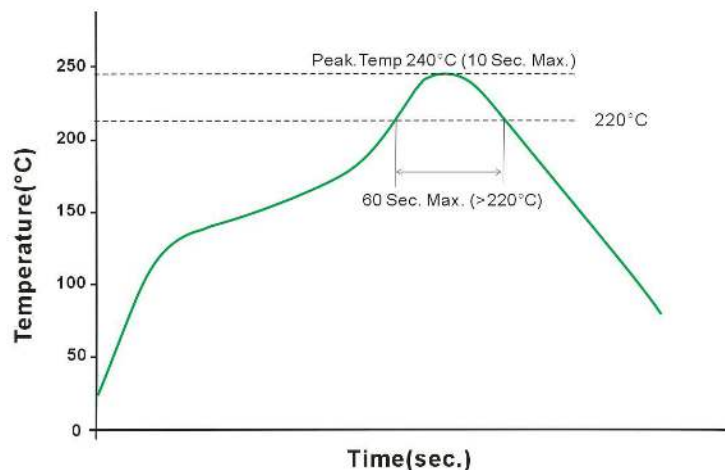

Remark: The curve applies only to the hot air reflow soldering.

● SIMPLIFIED SCHEMATIC

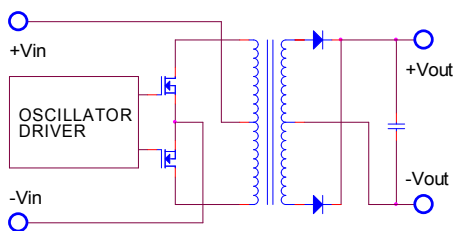

● TYPICAL APPLICATIONS

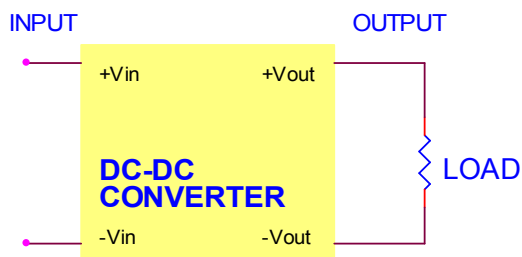

DERATING CURVES

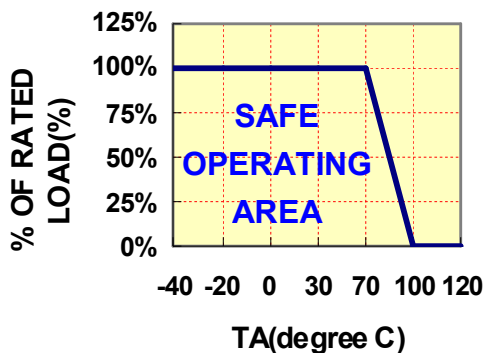

EFFICIENCY VS LOAD

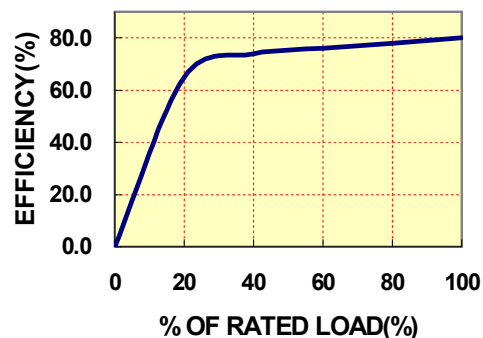

● INPUT FUSE SELECTION GUIDE(1) 1W 1000VDC ISOLATION

4.5-5.5V INPUT VOLTAGE(VDC)	10.8-13.2V INPUT VOLTAGE(VDC)	21.6-26.4V INPUT VOLTAGE(VDC)
750mA Slow-Blow Type	300mA Slow-Blow Type	150mA Slow-Blow Type

Note: Certain applications may require the installation of external fuse in front of the input.

● INPUT FUSE SELECTION GUIDE(2) 1.8W~2W 1000VDC ISOLATION

4.5-5.5V INPUT VOLTAGE(VDC)	10.8-13.2V INPUT VOLTAGE(VDC)	21.6-26.4V INPUT VOLTAGE(VDC)
1500mA Slow-Blow Type	600mA Slow-Blow Type	300mA Slow-Blow Type

Note: Certain applications may require the installation of external fuse in front of the input.

NU SERIES APPLICATION NOTES:

EXTERNAL CAPACITANCE REQUIREMENTS:

Output filtering is required for operation. A minimum of 10uF is needed. Output capacitance may be increased for additional filtering, not to exceed 220uF.

To meet the reflected ripple requirements of the converter, an input impedance of less than 0.5 ohm from DC to 250KHz is required.

We Can Offer EMC-Filter According To EN55011/22 Class B.

Negative Outputs:

A negative output voltage may be obtained by connecting the +OUT to circuit ground and connecting -OUT as the negative output.

FOR MORE INFORMATION CALL:

Danube Enterprise Co., Ltd.

Tel: 886-7-3755165

Fax: 886-7-3755330

E-mail: danube@ms10.hinet.net

Home Page

<http://www.danube.com.tw>

Additional Information :

한국 총판점 : (주)디웰전자 (Diwell Electronics Co., Ltd.)

경기도 군포시 당정동 358 군포창업보육센터 202호

202, Kunpo Business Incubator Center, 358,

Dangjung-Dong, Gunpo-City, Gyeonggi-Do, South Korea

Phone : 070-8235-0820 (+82-70-8235-0820)

Fax : 031-429-0821 (+82-31-429-0821)

Homepage: [http:// www.diwell.com](http://www.diwell.com)

기술 및 구매 문의 email : expoeb2@diwell.com,

dsjeong@diwell.com