



# Evaluation Board for the AD7718, 8/10-Channel, 24-Bit, Sigma Delta ADC

## EVAL-AD7718-EB

### FEATURES

- Full-Featured Evaluation Board for the AD7718
- On-Board Reference and Digital Buffers
- Various Linking Options
- PC Software for Control of AD7718

### INTRODUCTION

This Technical Note describes the evaluation board for the AD7718, 8/10-Channel, Low Voltage, Low Power, 24-Bit, Sigma Delta ADC. The AD7718 is a complete analog front end for low frequency measurement applications. The AD7718 is factory calibrated and therefore does not require field calibration. The device can accept low level input signals directly from a transducer and produce a serial digital output. It employs a sigma-delta conversion technique to realize up to 24 bits of no missing codes performance. The selected input signal is applied to a proprietary programmable gain front end based around an analog modulator. The modulator output is processed by an on-chip digital filter. The first notch of this digital filter can be programmed via an on-chip control register allowing adjustment of the filter cutoff and output update rate. Full data on the AD7718 is available in the AD7718 datasheet available from Analog Devices and should be consulted in conjunction with this Technical Note when using the evaluation board.

The evaluation board interfaces to the parallel port of an IBM compatible PC. Software is available with the

evaluation board which allows the user to easily program the AD7718.

Other components on the AD7718 Evaluation Board include two AD780s (precision 2.5V references), a 32.7680 kHz crystal and digital buffers to buffer signals to and from the PC.

### OPERATING THE AD7718 EVAL BOARD

#### Power Supplies

This evaluation board has two analog power supply inputs:  $AV_{DD}$  and  $AGND$ . An external +5V must be applied between these inputs which is used to provide the  $V_{DD}$  for the AD7718 and the reference. Digital Power connections are also required through  $DGND$  &  $DV_{DD}$ . The  $DV_{DD}$  is used to provide the  $DV_{DD}$  for the digital circuitry.  $DGND$  and  $AGND$  are connected together at the AD7718 GND pin. Therefore, it is recommended not to connect  $AGND$  and  $DGND$  elsewhere in the system.

All power supplies are decoupled to their respective grounds.  $DV_{DD}$  is decoupled using a 10 $\mu$ F tantalum capacitor and 0.1 $\mu$ F ceramic capacitor at the input to the evaluation board. It is again decoupled using 0.1 $\mu$ F capacitors as close as possible to each logic device.  $AV_{DD}$  is decoupled using a 10 $\mu$ F tantalum capacitor and 0.1 $\mu$ F ceramic capacitor as close as possible to the AD7718 and also at the reference.

Fig. 1. Evaluation Board Set-up

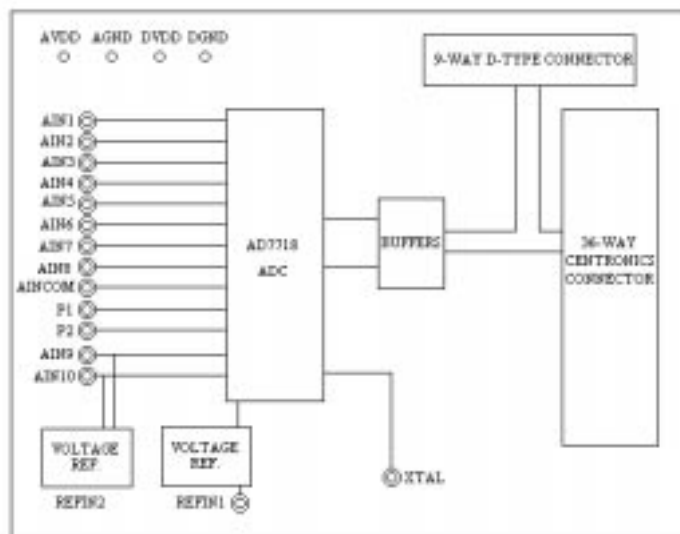

### REV. B

Information furnished by Analog Devices is believed to be accurate and reliable. However, no responsibility is assumed by Analog Devices for its use, nor for any infringements of patents or other rights of third parties which may result from its use. No license is granted by implication or otherwise under any patent or patent rights of Analog Devices.

One Technology Way, P.O. Box 9106, Norwood, MA 02062-9106, U.S.A.

Tel: 617/329-4700

Fax: 617/326-8703

# EVAL-AD7718-EB

## LINK AND SWITCH OPTIONS

There are fifteen link options which must be set for the required operating setup before using the evaluation board. The functions of these link options are outlined below.

### Link No. Function

- LK1-LK8 These links are in series with the AIN1 through AIN8 analog inputs respectively.  
With these links in place, the analog inputs on the relevant SKT input is connected directly to the respective AIN input on the part. For example, with LK1 in place, the analog input applied to SKT1 is connected directly to AIN1 of the AD7718.
- LK9 This link is in series with the AINCOM analog input.  
With this link in place, the analog input on SKT9 is connected directly to the AINCOM input on the part.
- LK10 This link is used to select the reference source for the REFIN2(+)/AIN9 input of the AD7718.  
With this link in position "A", REFIN2(+)/AIN9 is connected to the output of the on-board reference (AD780 - U2).  
With this link in position "B", REFIN2(+)/AIN9 is connected to SKT10. An external voltage applied to SKT10 can now be used as the REFIN2(+) for the AD7718 or as analog input AIN9, depending on how the AD7718 is configured.
- LK11 This link is used to select the reference source for the REFIN2(-)/AIN10 input of the AD7718.  
With this link in position "A", REFIN2(-)/AIN10 is connected directly to AGND.  
With this link in position "B", the REFIN2(-)/AIN10 is connected to SKT11. An external voltage applied to SKT11 can now be used as the REFIN2(-) for the AD7718 or as analog input AIN10, depending on how the AD7718 has been configured.
- LK12 This link is used to select the reference source for the REFIN1(+) input of the AD7718.  
With this link in position "A", REFIN1(+) is connected to the output of the on-board reference (AD780 - U6).  
With this link in position "B", REFIN1(+) is connected to SKT12. An external voltage applied to SKT12 can now be used as the REFIN1(+) for the AD7718.
- LK13 This link is used to select the reference source for the REFIN1(-) input of the AD7718.  
With this link in position "A", REFIN1(-) is connected directly to AGND.  
With this link in position "B", the REFIN1(-) is connected to SKT13. An external voltage applied to SKT11 can now be used as the REFIN1(-) for the AD7718.
- LK14&15 This option selects the master clock source for the AD7718. The master clock is generated by the on-board crystal or from an external source via SKT7. This is a double link and both links must be moved together for the correct operation of the evaluation board.  
With both links in position "A", the external clock option is selected and an external clock applied to SKT7 is routed to the XTAL1 pin of the AD7718.  
With both links in position "B", the on-board crystal is selected to provide the master clock to the AD7718.

## SET-UP CONDITIONS

Care should be taken before applying power and signals to the evaluation board to ensure that all link positions are as per the required operating mode. Table 1 shows the position in which all the links are set when the evaluation board is sent out.

**Table 1: Initial Link and Switch Positions**

Link No.	Position	Function
LK1-LK9	IN	Connects analog inputs from SKT1-SKT9 to the input pins AIN1-AIN8 & AINCOM of the AD7718.
LK10	A	The on-board reference (U2) provides the reference voltage for the REFIN2(+)/AIN9 input of the AD7718.
LK11	A	This connects the REFIN2(-)/AIN10 input of the AD7718 to AGND.

LK12	A	The on-board reference (U6) provides the reference voltage for the REFIN1(+) input of the AD7718.
LK13	A	This connects the REFIN1(-) input of the AD7718 to AGND.
LK14&15	B	Both links in position B to select the on-board crystal as the master clock for the AD7718.

## EVALUATION BOARD INTERFACING

Interfacing to the evaluation board is via either a 9-way d-type connector, J4 or a 36-way centronics connector, J1. The pin-out for the J4 connector is shown in Fig. 2 and its pin designations are given in Table 2. The pin-out for the J1 connector is shown in Fig. 3 and its pin designations are given in Table 3.

J1 is used to connect the evaluation board to the parallel (printer) port of a PC. Connection is via a standard printer cable. J4 is used to connect the evaluation to any other system. The evaluation board should be powered up before a cable is connected to either of these connectors.

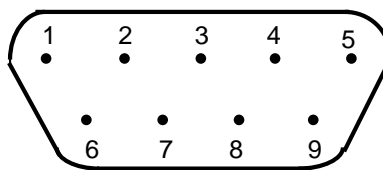

Fig. 2: Pin Configuration for the 9-Way D-Type Connector, J4.

**Table 2.: J4 Pin Description <sup>1</sup>**

1	SCLK	Serial Clock. The signal on this pin is buffered before being applied to the SCLK pin of the AD7718.
2	$\overline{\text{RDY}}$	Logic output. This is a buffered version of the signal on the AD7718 $\overline{\text{RDY}}$ pin
3	$\overline{\text{CS}}$	Chip Select. The signal on this pin is buffered before being applied to the $\overline{\text{CS}}$ pin on the AD7718.
4	$\overline{\text{RESET}}$	Reset Input. Data applied to this pin is buffered before being applied to the AD7718 $\overline{\text{RESET}}$ pin.
5	DIN	Serial Data Input. Data applied to this pin is buffered before being applied to the AD7718 DIN pin.
6	DGND	Ground reference point for the digital circuitry. Connects to the DGND plane on the Evaluation board.
7	DO UT	Serial Data Output. This is a buffered version of the signal on the AD7718 DO UT pin.
8	DV <sub>DD</sub>	Digital Supply Voltage. If no voltage is applied to the board's DV <sub>DD</sub> input terminal then the voltage applied to this pin will supply the DV <sub>DD</sub> for the digital buffers.
9	NC	Not Connected.

Note

<sup>1</sup> An explanation of the AD7718 functions mentioned here is given in Table 3 below as part of the J1 pin descriptions.

**Table 3: 36-Way Connector Pin Description**

1	NC	No Connect. This pin is not connected on the evaluation board.
2	DIN	Serial Data Input. Data applied to this pin is buffered before being applied to the AD7718 DIN pin. Serial Data Input with serial data being written to the input shift register on the part. Data from this input shift register is transferred to the calibration or control registers, depending on the register selection bits of the Communications Register.
3	$\overline{\text{RESET}}$	Reset Input. The signal on this pin is buffered before being applied to the $\overline{\text{RESET}}$ pin of the AD7718. $\overline{\text{RESET}}$ is an active low input which resets the control logic, interface logic, calibration coefficients, digital filter and analog modulator of the part to power-on status.

# EVAL-AD7718-EB

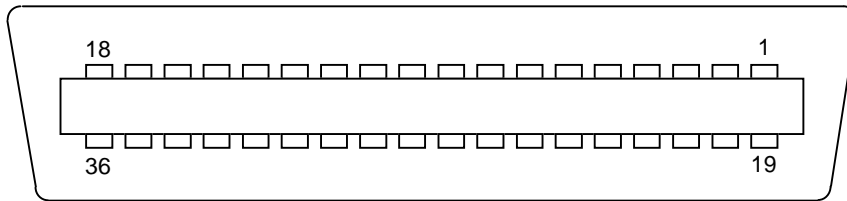

Fig. 3: 36-way Centronics (SKT2) Pin Configuration

4	$\overline{CS}$	Chip Select. The signal on this pin is buffered before being applied to the $\overline{CS}$ pin of the AD7718. $\overline{CS}$ is an active low Logic Input used to select the AD7718. With this input hard-wired low, the AD7718 can operate in its three-wire interface mode with SCLK, DIN and DOUT used to interface to the device. $\overline{CS}$ can be used to select the device in systems with more than one device on the serial bus or as a frame synchronization signal in communicating with the AD7718.
5	SCLK	Serial Clock. The signal on this pin is buffered before being applied to the SCLK pin of the AD7718. An external serial clock is applied to this input to read/write serial data from/to the AD7718. This serial clock can be continuous with all data transmitted in a continuous train of pulses. Alternatively, it can be non-continuous with the information being transmitted to the AD7718 in smaller batches of data.
6	$\overline{SYNC}$	Logic Input. The signal on this pin is buffered before being applied to the $\overline{SYNC}$ pin of the AD7718. The $\overline{SYNC}$ input allows for synchronisation of the digital filters and modulators across a number of AD7718s. While $\overline{SYNC}$ is low, the nodes of the digital filter, the filter control logic and the calibration control logic are held in a reset state.
7-8	N C	No Connect. These pins are not connected on the evaluation board.
9	$DV_{DD}$	Digital Supply Voltage. This provides the supply voltage for the buffer chips, U3-U5, which buffer the signals between the AD7718 and J1/J4.
10	$\overline{RDY}$	Logic output. This is a buffered version of the signal on the AD7718 $\overline{RDY}$ pin. A logic low on this output indicates that either the Main ADC or Auxiliary ADC has valid data in their data register. The $\overline{RDY}$ pin will return high upon completion of a read operation of a full output word. If data is not read $\overline{RDY}$ will return high prior to the next update indicating to the user that a read operation should not be initiated. The $\overline{RDY}$ pin also returns low after the completion of a calibration cycle. The $\overline{RDY}$ pin is effectively the NOR of the RDY0 and RDY1 bits in the Status register. If one of the ADCs is disabled the $\overline{RDY}$ pin reflects the active ADC. $\overline{RDY}$ does not return high after a calibration until the mode bits are written to enabling a new conversion or calibration.
11-12	N C	No Connect. These pins are not connected on the evaluation board.
13	D O U T	Serial Data Output. This is a buffered version of the signal on the AD7718 DOUT pin. Serial Data Output with serial data obtained from the output shift register on the AD7718. The output shift register can contain information from of the on-chip registers depending on the register selection bits of the Communications Register.
14-18	N C	No Connect. These pins are not connected on the evaluation board.
19-30	D G N D	Ground reference point for digital circuitry. Connects to the DGND plane on the evaluation board.
31-36	N C	No Connect. These pins are not connected on the evaluation board.

## SOCKETS

There are eighteen sockets relevant to the operation of the AD7718 on this evaluation board. The functions of these sockets are outlined in Table 4.

**Table 4. Socket Functions**

Socket	Function
J4	9-way D-Type connector used to interface to other systems.
J1	36-way centronics connector used to interface to PC via parallel printer port.

- SKT1 Sub-Miniature BNC (SMB) Connector. The analog input signal for the AIN1 input of the AD7718 is applied to this socket.
- SKT2 Sub-Miniature BNC (SMB) Connector. The analog input signal for the AIN2 input of the AD7718 is applied to this socket.
- SKT3 Sub-Miniature BNC (SMB) Connector. The analog input signal for the AIN3 input of the AD7718 is applied to this socket.
- SKT4 Sub-Miniature BNC (SMB) Connector. The analog input signal for the AIN4 input of the AD7718 is applied to this socket.
- SKT5 Sub-Miniature BNC (SMB) Connector. The analog input signal for the AIN5 input of the AD7718 is applied to this socket.
- SKT6 Sub-Miniature BNC (SMB) Connector. The analog input signal for the AIN6 input of the AD7718 is applied to this socket.
- SKT7 Sub-Miniature BNC (SMB) Connector. The analog input signal for the AIN7 input of the AD7718 is applied to this socket.
- SKT8 Sub-Miniature BNC (SMB) Connector. The analog input signal for the AIN8 input of the AD7718 is applied to this socket.
- SKT9 Sub-Miniature BNC (SMB) Connector. The analog input signal for the AINCOM input of the AD7718 is applied to this socket.
- SKT10 Sub-Miniature BNC (SMB) Connector. The voltage for the REFIN2(+)/AIN9 input of the AD7718 is applied to this socket - reference voltage when the input is configured as REFIN2(+) and an analog input when the input is configured as AIN9.
- SKT11 Sub-Miniature BNC (SMB) Connector. The voltage for the REFIN2(-)/AIN10 input of the AD7718 is applied to this socket - reference voltage when the input is configured as REFIN2(-) and an analog input when the input is configured as AIN10.
- SKT12 Sub-Miniature BNC (SMB) Connector. The reference voltage for the REFIN1(+) input of the AD7718 is applied to this socket when the board is configured for an externally applied reference voltage.
- SKT13 Sub-Miniature BNC (SMB) Connector. The reference voltage for the REFIN1(-) input of the AD7718 is applied to this socket when the board is configured for an externally applied reference voltage.
- SKT14 Sub-Miniature BNC (SMB) Connector. The output value from AD7718 I/O pin P1

is available from this socket when P1 is configured as an output. The input signal for AD7718 I/O pin P1 is applied to this input when P1 is configured as an input.

- SKT15 Sub-Miniature BNC (SMB) Connector. The output value from AD7718 I/O pin P2 is available from this socket when P2 is configured as an output. The input signal for AD7718 I/O pin P2 is applied to this input when P2 is configured as an input.

- SKT16 Sub-Miniature BNC (SMB) Connector. The master clock signal for the XTAL1 input of the AD7718 is applied to this socket when the board is configured for an externally applied master clock. The AD7718 can be operated with internal clock frequencies in the range 32.768 kHz +/- 10%.

## CONNECTORS

There are two connectors on the AD7718 evaluation board as outlined in Table 5.

**Table 5. Connector Functions**

Connector	Functions
J3	PCB Mounting Terminal Block. The Digital Power Supply to the Evaluation Board is provided via this Connector if it is not being supplied via SKT1 or SKT2.
J2	PCB Mounting Terminal Block. The Analog Power Supply to the Evaluation Board must be provided via this Connector.

# EVAL-AD7718-EB

## **SWITCHES**

There is one switch on the AD7718 Evaluation board. SW1 is a push-button reset switch. Pushing this switch activates the active low  $\overline{\text{RESET}}$  input on the AD7718 which resets the control logic, interface logic, calibration coefficients, digital filter and analog modulator of the part to power-on status.

## **AD7718 SOFTWARE DESCRIPTION**

The AD7718 evaluation board is shipped with a CD-ROM containing software that can be installed onto a standard PC to control the AD7718.

The software uses the printer port of the PC to communicate with the AD7718, so a Centronics printer cable is used to connect the PC to the evaluation board.

## **Software Requirements and Installation**

The software runs under Windows ME 2000 NT™ and typically requires 8Mb of RAM.

To install the software the user should start Windows and insert the CD-ROM disc. The installation software should launch automatically. If not, use Windows Explorer to locate the file 'setup.exe' on the CD-ROM. Double clicking on this file will start the installation procedure. The user is prompted for a destination directory which is "C:\Program Files\Analog Devices\AD7718" by default. Once the directory has been selected the installation procedure will copy the files into the relevant directories on the hard drive. The installation program will create a Program Group called "Analog Devices" with sub-group 'AD7718' in the "Start" taskbar. Once the installation procedure is complete the user can double click on the AD7718 icon to start the program.

## **Features of the Software**

1. The software will allow the user to write to and read from all the registers of the AD7718.
2. Data can be read from the AD7718 and displayed or stored for later analysis.
3. The data that has been read can be exported to other packages such as Mathcad or Excel for further analysis.

What follows is a description of the various windows that appear while the software is being used. Fig. 4. shows the main screen that appears once the program has started. The printer port that will be used by the software is determined automatically. There are three possible printer ports that can be handled by the software, LPT1 (standard), LPT2 and PRN. The user can change to another printer port by clicking on the 'Printer Port' dropdown menu. A brief description of each of the buttons on the main screen follows:

- ProgramAD7718** Allows the user to program or read the on-chip registers of the AD7718.
- ReadData** Allows the user to read a number of samples from the AD7718. These samples can be stored for further analysis or just displayed for reference.
- NoiseAnalysis** Allows the user to perform noise analysis on the data that has been read in from the ADC.
- ResetAD7718** Allows the user to perform a software or hardware reset on the AD7718.
- Read From File** Allows the user to read in previously stored data for display or analysis.
- Write To File** Allows the user to write the current set of data to a file for later use - user needs to specify single or multi-channel data.
- About** Provides information about the version of software being used.
- Multi-Channel Test** Allows the user to display samples from selected channels at different update rates, polarities and ranges.
- Quit** Ends the program

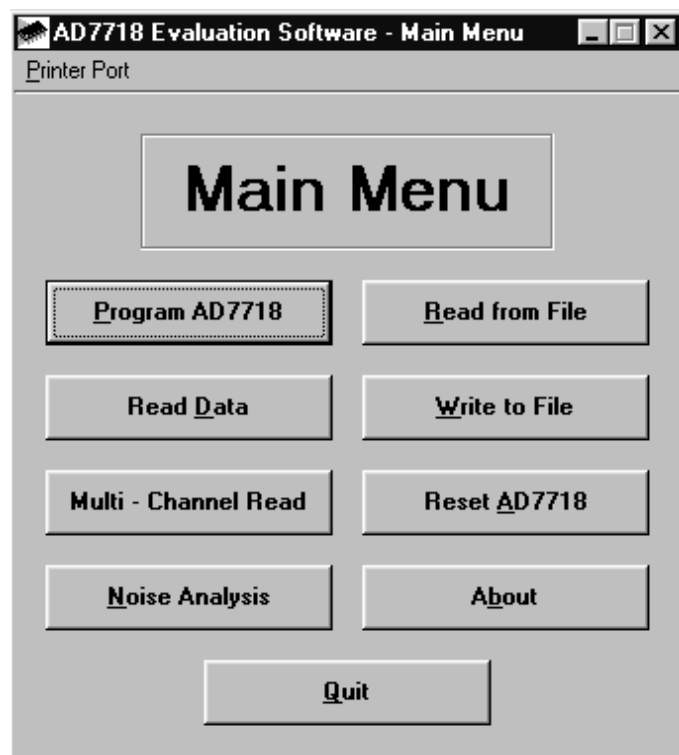

Fig. 4. The Main Screen

# EVAL-AD7718-EB

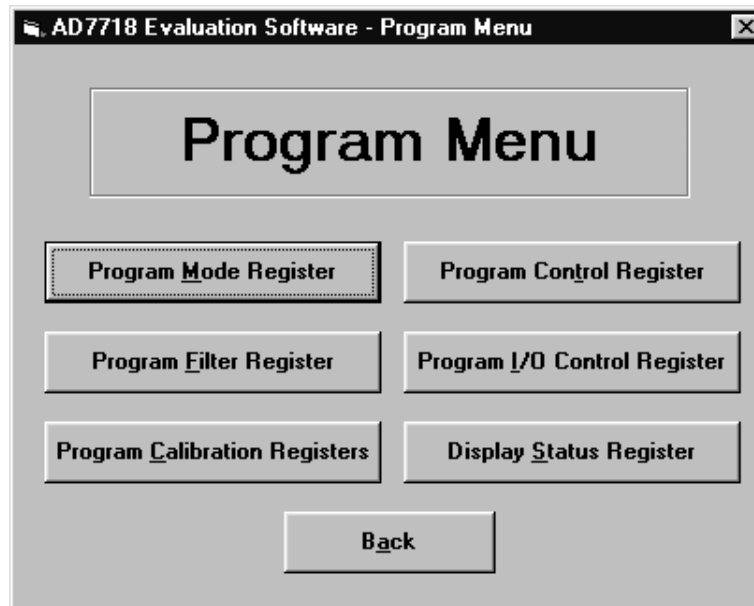

Fig. 5. The Program AD7718 Screen

## The Program AD7718 Screen

Fig. 5. shows the screen that appears when the Program AD7718 button is selected. This screen allows the user to select which register is to be programmed.

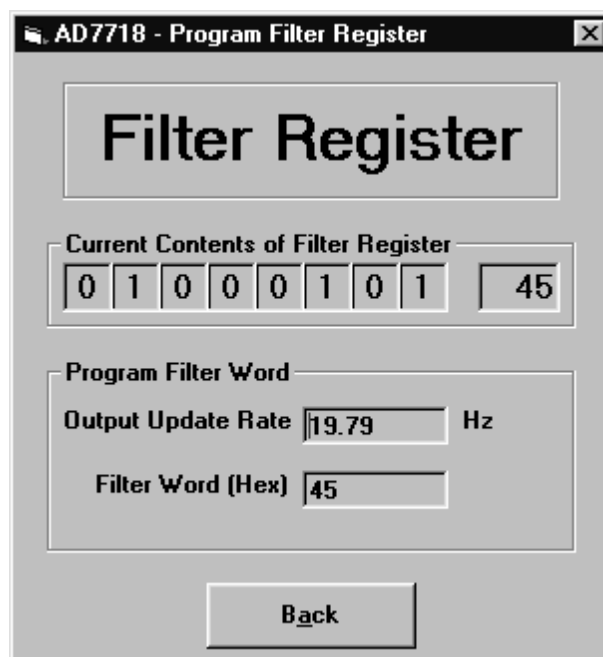

Fig. 6. The Filter Register Screen

## The Filter Register Screen

Fig. 6. shows the Filter Register screen. When the screen is loaded the software will read the current contents from the Filter Register of the AD7718 and change the display accordingly. The Filter register is used to change the update rate of the AD7718, the allowable range for the word written to the Filter Register is 13(dec) to 255(dec) or 0D(Hex) to FF(Hex). The user can enter the filter word in Hex values in the text boxes provided. The user should consult the datasheets for more information on the use of the Filter Register.



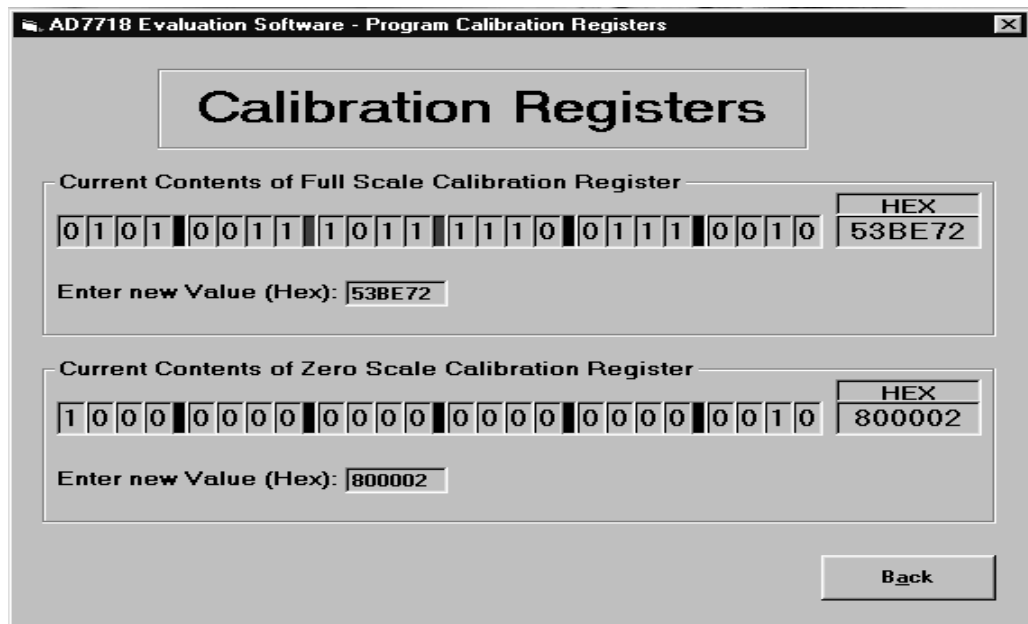

Fig. 7. The Calibration Registers Screen

#### The ADC Calibration Registers Screen

Fig. 7. shows the ADC Calibration Registers screen. When this screen is displayed the values of the Gain and Offset Registers are read from the AD7718 and displayed. The user has the ability to change the values of either register if required. the default value for the Fullscale Cal Register is 535xx5 hex and the default value for the Zero Scale Cal Register is 800000 hex.

# EVAL-AD7718-EB

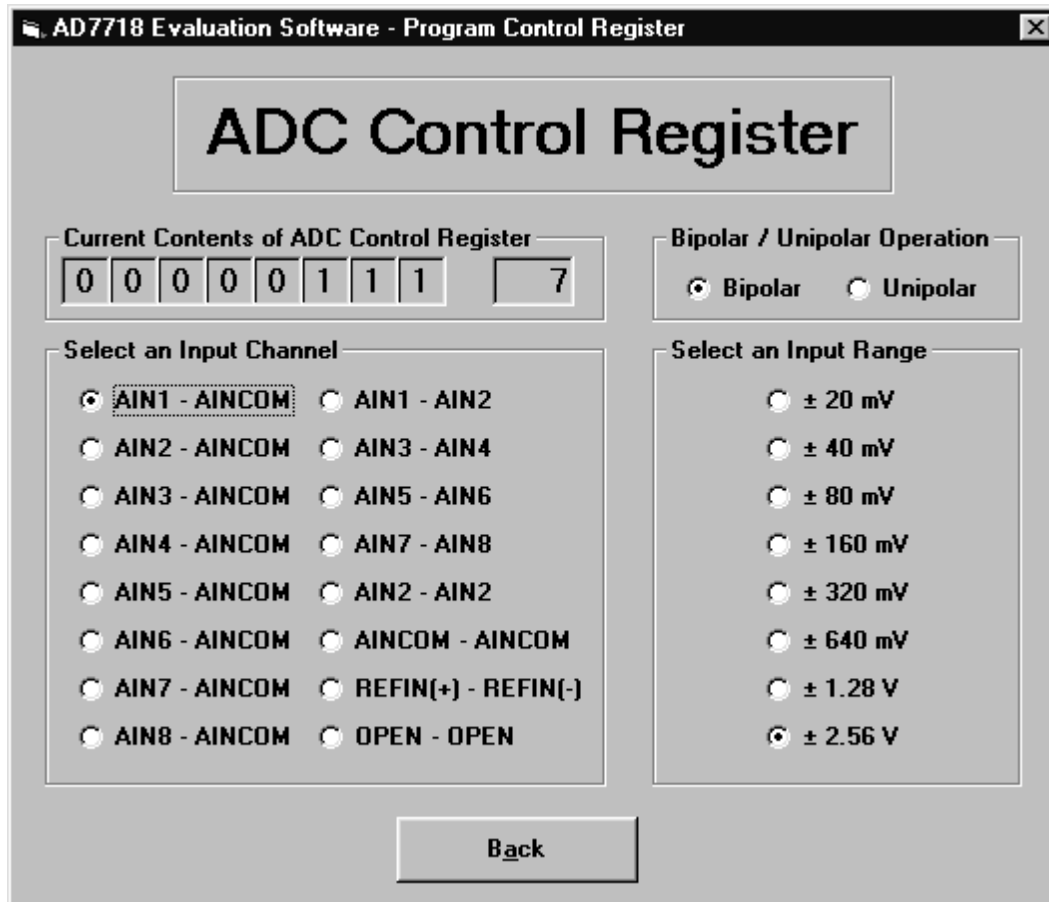

Fig. 8. The ADC Control Register Screen

## The ADC Control Register Screen

Fig. 8. shows the ADC Control Register Screen. This register controls Bipolar/Unipolar operation, Channel selection and Range selection for the Main ADC. When the screen is loaded the software reads the current contents from the ADC Control Register of the AD7718 and sets the buttons accordingly. Note if the Channel Configure bit is set in the Mode Register, the AD7718 channel configuration is changed - see AD7718 datasheets for more information. Everytime a change is made, the software writes the new conditions to the AD7718 and then reads back from the ADC Control Register for conformation.

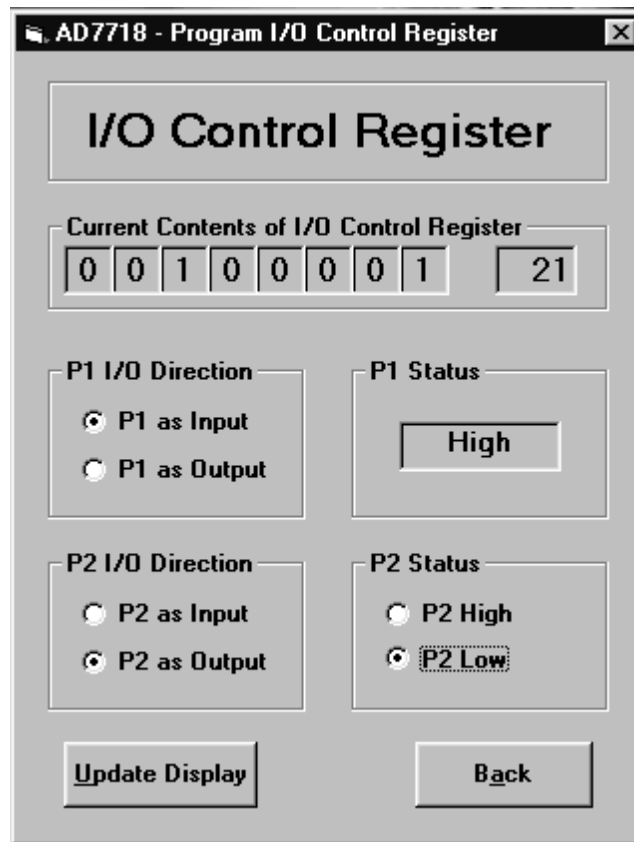

Fig. 9. The I/O and Current Source Control Register Screen

#### The I/O Control Register Screen

Fig.9. shows the I/O Control Register Screen. This screen allows the user to control the I/O ports P1 & P2. When the screen is loaded, the software reads the current contents of the I/O Control Register of the AD7718 and sets the buttons accordingly.

The two I/O ports P1 & P2 can be selected as inputs or outputs, the user can set the outputs as required - note a 'high' represents a 5V output on the pin, 'low' represents AGND. The user can also read in the value at the inputs P1 & P2 if configured as inputs. Note pressing Update Display button will read the current contents of the I/O Control Register and update the screen.

Everytime a change is made, the software writes the new conditions to the AD7718 and then reads back from the I/O Control Register for conformation - ignoring databits P1DAT - P2DAT. Refer to AD7718 datasheets for more information.

# EVAL-AD7718-EB

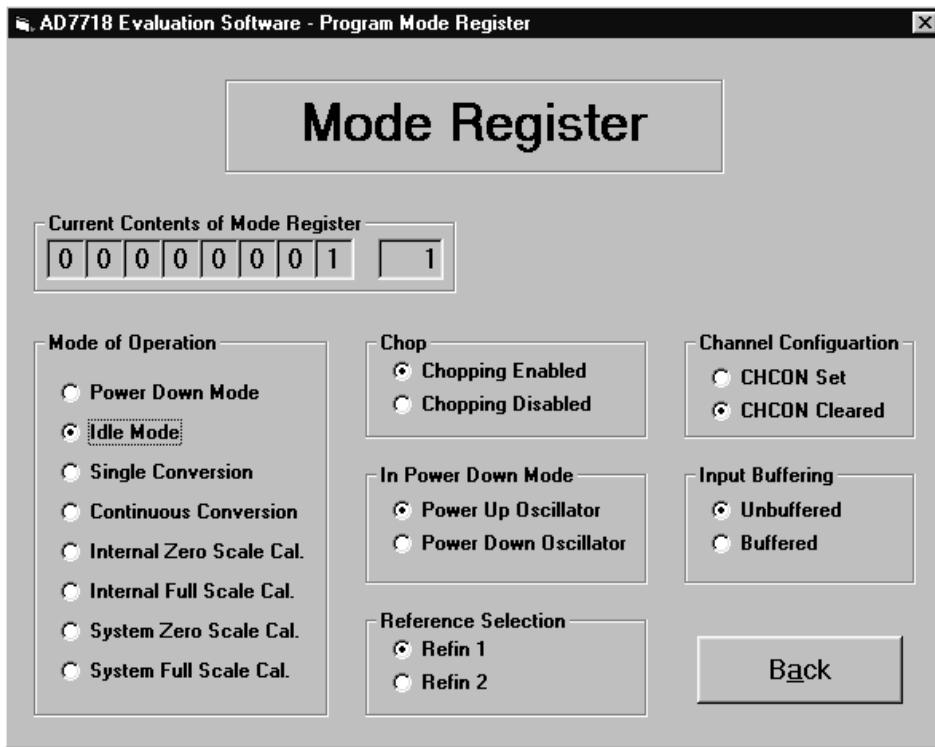

Fig. 10. The Mode Register Screen

## The Mode Register Screen

The Mode Register Screen is shown in Fig. 10. When the screen is loaded the software reads the current contents from the Mode Register of the AD7718 and sets the buttons accordingly. This screen allows the user to change the operating mode of the AD7718, change the channel configuration, turn chopping on/off, select the reference voltage and power down the crystal oscillator. When the user selects a calibration the software will start a calibration by writing to the AD7718 (prompt user for input if system calibration) and then monitor the RDY pin. A falling edge of the RDY pin will indicate that the calibration has been completed. After a calibration the AD7718 is placed in the idle mode and the screen is updated to indicate this. Everytime a change is made, the software writes the new conditions to the AD7718 and then reads back from the Mode Register for conformation. The AD7718 should be powered-down or placed in Idle Mode before writing to Filter, ADC Control or Calibration registers. The default status for the Mode register is 0 hex - refer to AD7718 datasheets for more information.

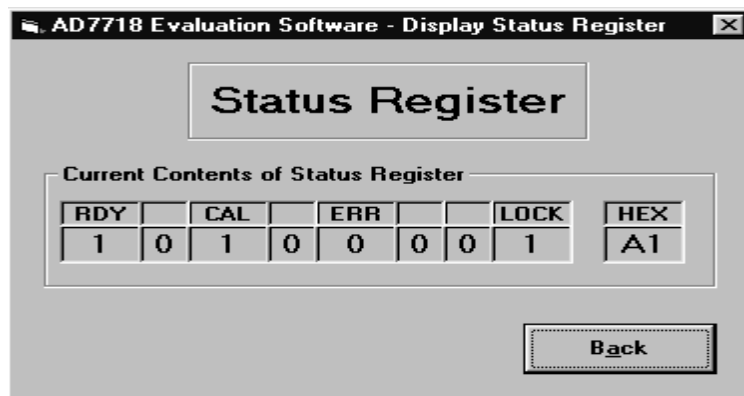

Fig. 11. The Status Register Screen

## The Status Register Screen

Fig. 11. shows the Status Register Screen. When the screen is loaded the software reads the current contents from the Status Register of the AD7718 and sets the buttons accordingly. This is a read-only register and flags the operating conditions of the AD7718 such as data ready or ADC Error. Refer to AD7718 datasheets for more information.

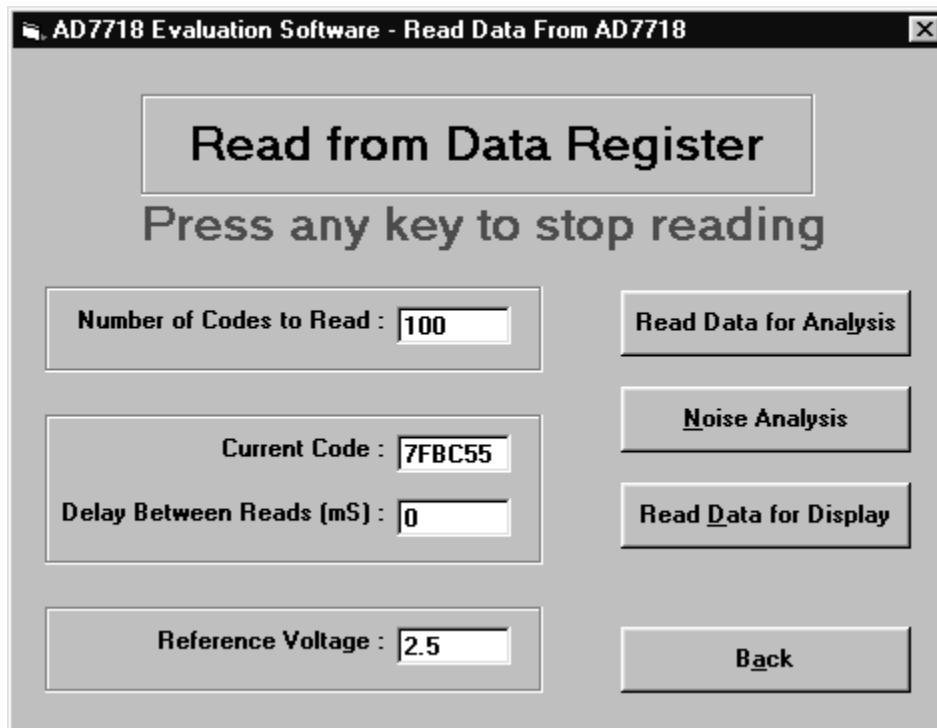

Fig. 12. The Read Data from Main ADC Screen

#### The Read Data from ADC Screen

Fig. 12. shows the ADC Read Data screen. This is where the user can read a number of samples from the AD7718 ADC. The user has the option of either reading data for analysis or display.

When the Read For Analysis button is selected the software will read the required number of samples from the AD7718 ADC and store them in an array so that they can be graphed or analysed later. It is possible to read and graph up to 5000 samples at any one time. The read can be interrupted with a user key press.

When the Read for Display button is selected the software will read one sample from the AD7718 and display its value in the Current Code text box. The software will continue to read and display the samples until a key has been pressed. It is possible to add a delay to the read cycle by entering the required number of milliseconds between reading samples. It should be noted however that the accuracy of the time delay can be affected by other programs running under Windows, therefore this method is not suitable where equidistant sampling is required.

# EVAL-AD7718-EB

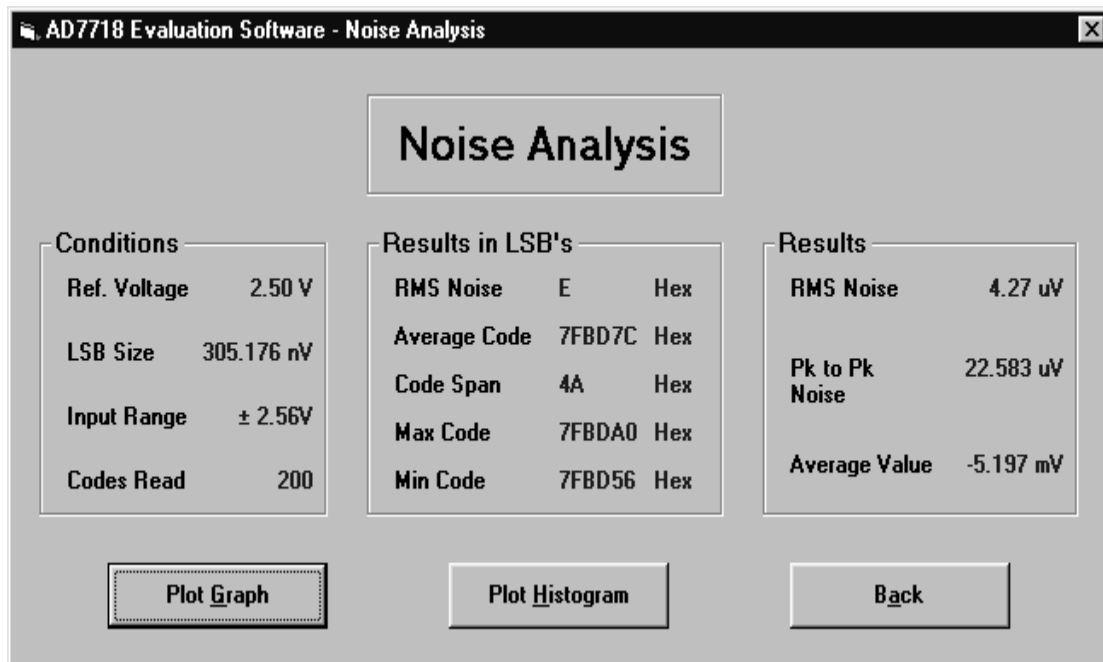

Fig. 13. The ADC Noise Analysis Screen

## The Noise Analysis Screen

Once data has been read from the AD7718 ADC, it is possible to perform some analysis on it. Fig. 13 shows the ADC Noise Analysis Screen. This screen displays the maximum and minimum codes read from the AD7718 ADC (in decimal and hexadecimal), as well as the average code, the average value and the RMS and Peak-Peak noise values. From this screen it is possible to display the data on a graph or as a histogram of codes. Figures 14 & 15 show the Graph and Histogram screens.

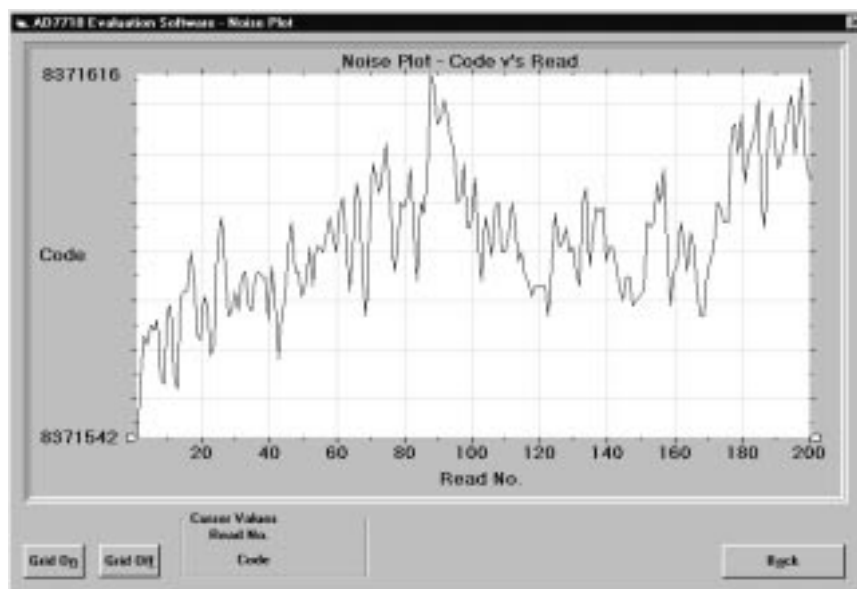

Fig. 14. The Graph Screen

## The Graph Screen

Fig. 14 shows the Graph Screen. This screen displays the data in a graph format. A grid can be placed on the graph by pressing the Grid on/off button. The graph screen also has zoom and scroll functions using the two white handles at either end of the x-axis.

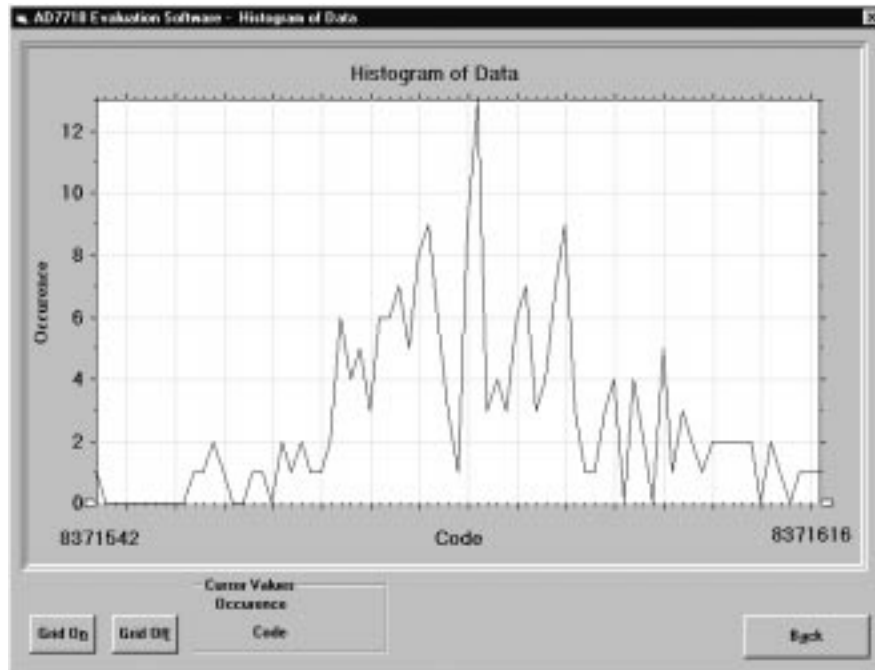

Fig. 15. The Histogram Screen

# EVAL-AD7718-EB

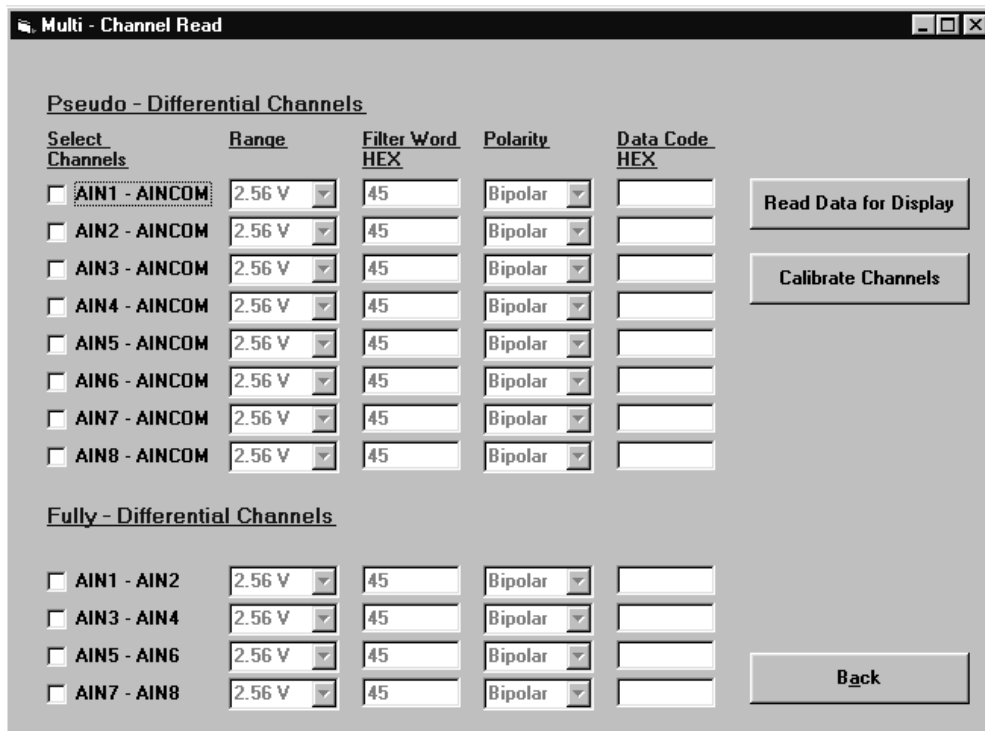

Fig. 16. The Multi-Channel Test Screen

## The Multi-Channel Test Screen

Fig. 16 shows the Multi-Channel Test Screen. This screen allows the user to select the channels for the multi-channel test. The user can specify range, update rate & polarity for the data. Note if the user selects an pseudo-differential channel, the respective fully-differential channel can't be used. This screen also allows the user to carry out internal and full-scale calibrations on all selected channels by clicking on the 'Calibration' button. The data code read from each channel is displayed in hex format.





# EVAL-AD7718-EB

**Table 6. Component Listing and Manufacturers**

## INTEGRATED CIRCUITS

Component	Location	Vendor
AD7718	U1	Analog Devices
AD780AN	U2/U6	Analog Devices
74HC4050N	U3	Philips
74C08SMD	U4	Texas Instruments
74ACT244	U5	Fairchild Semiconductor
SD103C	D1/D2	ITT

## CAPACITORS

Component	Location	Vendor
10 $\mu$ F $\pm$ 20% Tantalum (16 V)	C11 C13 C15 C17 C21 C23 C24 C26	AVX-Kyocera Mfrs No. TAG106MO16
0.1 $\mu$ F Ceramic (0805 SMD)	C1-C10 C12 C14 C20 C22 C25 C27-C30 FEC No. 499-768	

## RESISTORS

Component	Location	Vendor
Short Circuits	R1-R9	Bourns
10k $\Omega$ $\pm$ 5% 0.25W Carbon Film	R11-R13	Bourns
3k $\Omega$ $\pm$ 5% 0.25W Carbon Film	R14	Bourns

## LINK OPTIONS

Component	Location	Vendor
Pin Headers	Lk1-Lk9 (1x2 way) Mfrs No. M20-9983606	Harwin
		Lk10-Lk14 (2x2 way)
Shorting Plugs	Pin Headers (15 required)	Harwin Mfrs No. M7571-05

## SWITCH

Component	Location	Vendor
Sealed Push Button Switch	SW1	Omron Mfrs No. B3W1000

## SOCKETS

Component	Location	Vendor
Miniature BNC Connectors	SKT1-SKT16	M/A - Com Greenpar Mfrs No. B65N07G999X99
9-Way D-Type Connector	J4	McMurdo Mfrs No. SDE9PNTD
36 Way Centronics Connector	J1	Fujitsu Mfrs No. FCN785J036G0
2 Way Terminal Block	J1J2	Bulgin RIA

# EVAL-AD7718-EB

Low profile socket

U2,U3,U6

Harwin (32 pins needed)  
Farnell No. 519-959

## CRYSTAL OSCILLATOR

### Component

32.768 kHz Oscillator

### Location

Xtal 1

### Vendor

IQD  
FEC No. 221-533

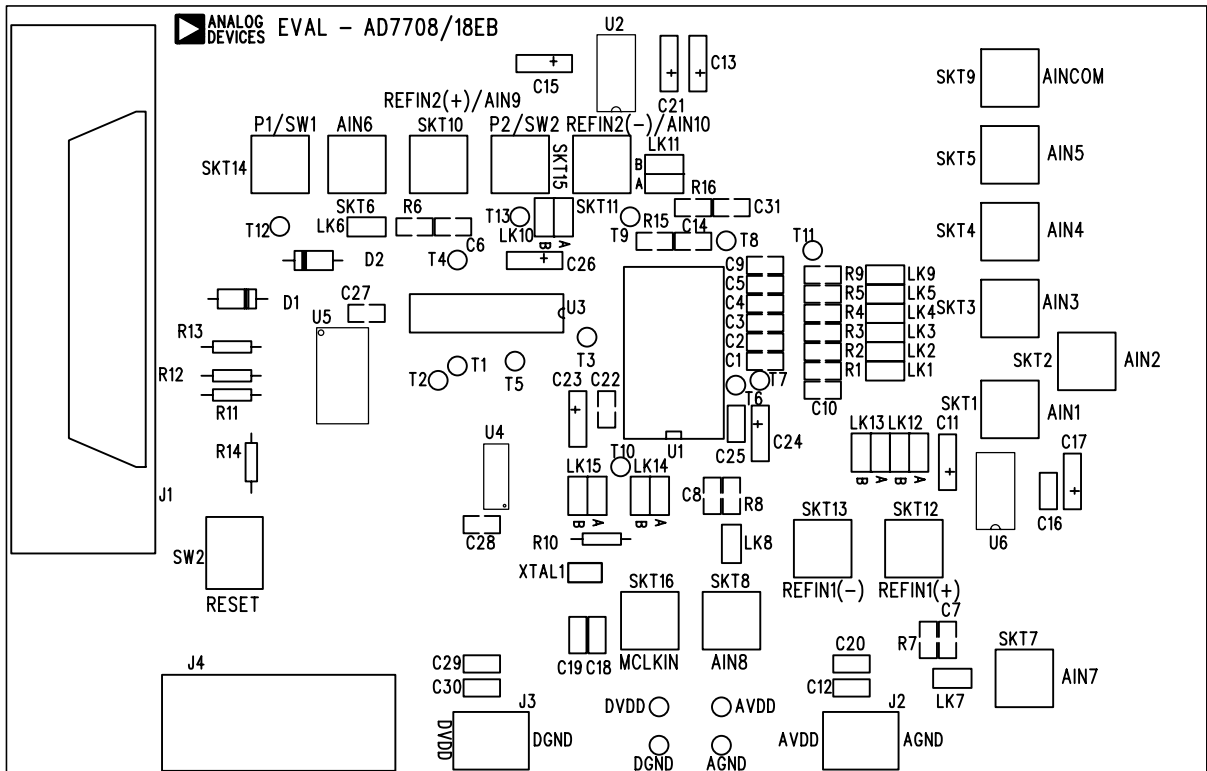

Fig. 22. The Evaluation Board Component Layout Diagram

# EVAL-AD7718-EB

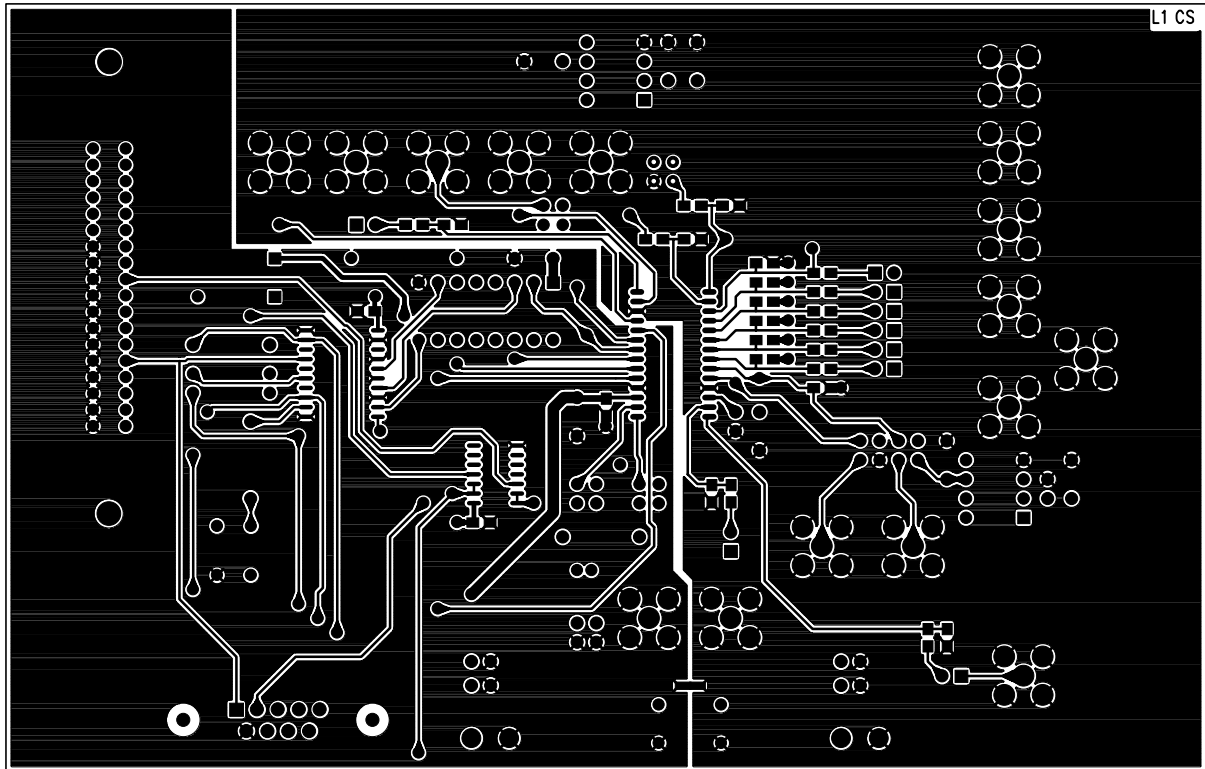

Fig. 23. The Evaluation Board Component Side Artwork

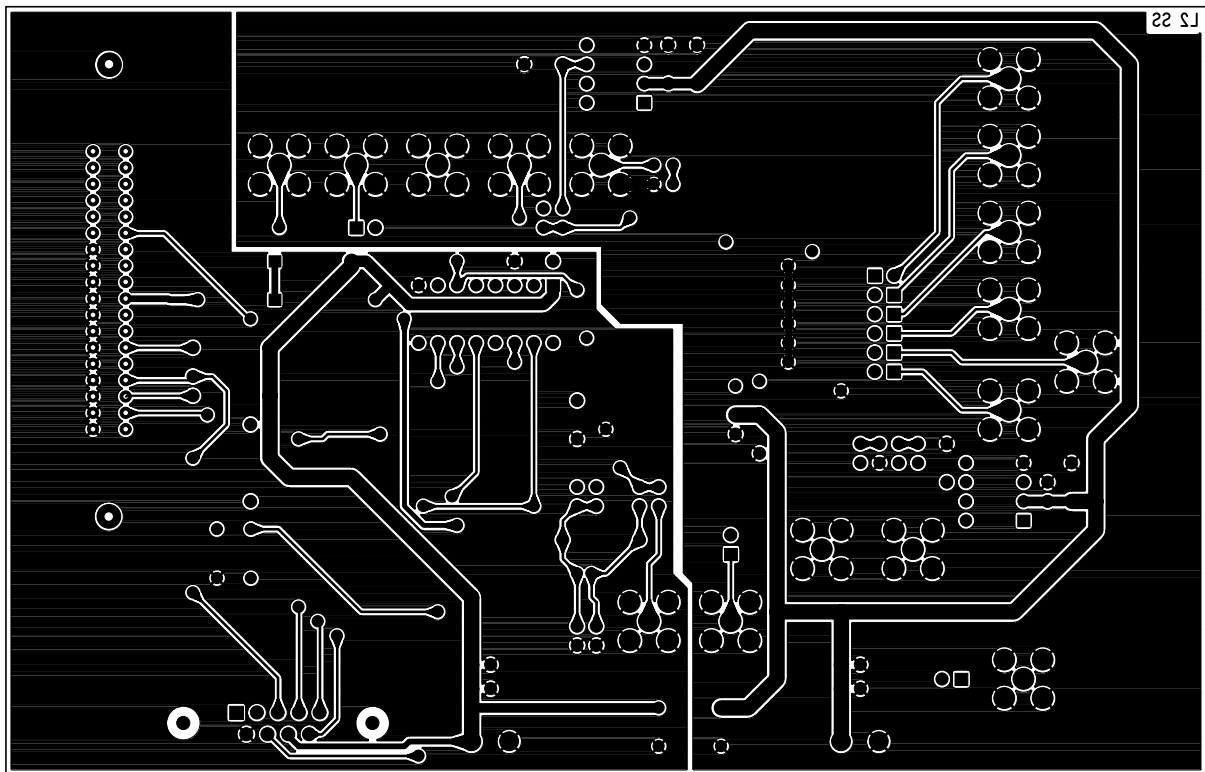

Fig. 23. The Evaluation Board Solder Side Artwork