



SPECIFICATION

OF PRODUCTS

PRODUCT NAME: DIELECTRIC CERAMIC FILTER

PART NUMBER : ECS-DCF-102

Approved by	Checked by	Drawn by
D. Kelly	A. Anderson	I. Lee

ECS Inc. International

15351 W. 109th Street, Lenexa, Kansas 66219

Tel : 1-913-782-7787

Fax : 1-913-782-6991

Web : www.ecsxtal.com



ECS Inc. International

Approval Sheet	
Customer	
Supplier P/N	ECS-DCF-102
Customer P/N	

Customer's Approval Certificate	
Checked & Approval by	
Date	

Version	Reason Of Modification	Modification	Drawn	Checked	Approval	Date

Please return this copy as a certification of your approval.



ECS Inc. International

1. SCOPE

This specification shall cover the characteristics of the dielectric ceramic filter with the type ECS-DCF-102.

2. PART NO.

PART NUMBER
ECS-DCF-102
CUSTOMER PART NO

3. OUTLINE DIMENSIONS AND MARK

3.1 Appearance: No visible damage and dirt.

3.2 Construction: SMD dielectric ceramic Monoblock.

3.3 The products conform to the RoHS directive and national environment protection law.

3.4 Dimensions and mark

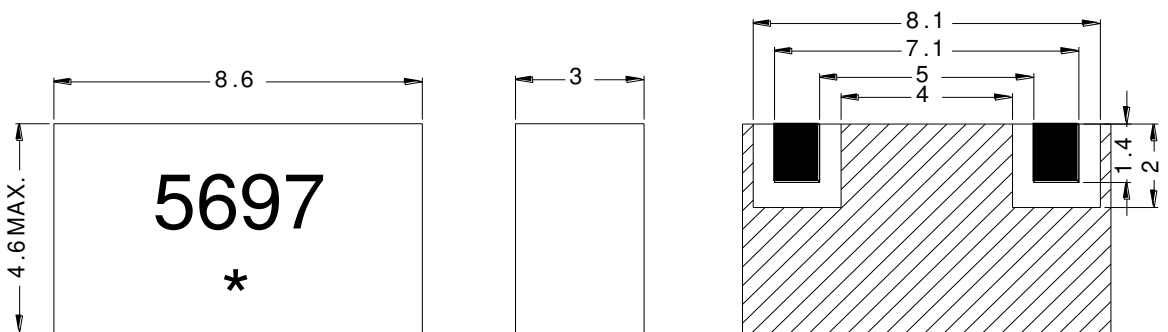

* : MONTHLY CODE

 I/O PORT

 GROUND

TOLERANCE : ± 0.20
UNIT: mm



ECS Inc. International

3.5 RECOMMENDED PC BOARD PATTERN

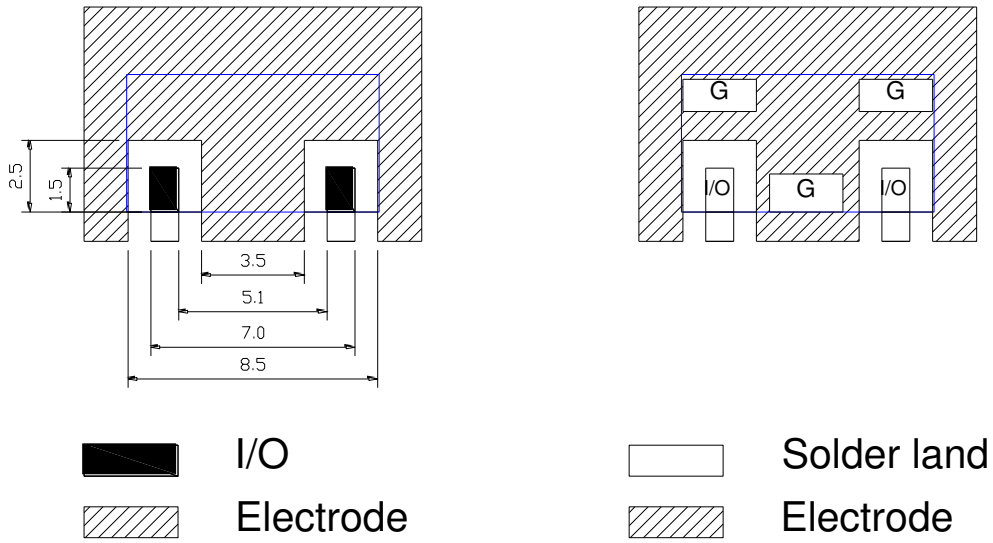

Shielding case layout guide (MIN)

shielding case

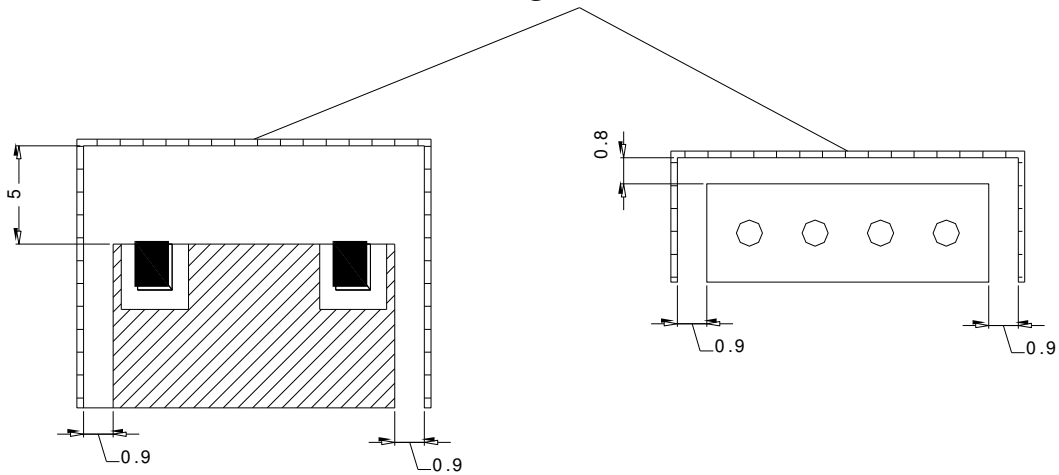



ECS Inc. International

4. ELECTRICAL SPECIFICATIONS

4.1 RATING

Items	Requirement
Withstand DC Voltage	50V (1min max)
Insulation Resistance MΩ min.	100 (10V, 1min±5s)
Storage temperature	-40 ~ 85°C
Operation Temperature Range	-40 ~ 85°C

4.2 ELECTRICAL SPECIFICATIONS

Items	Requirement
Center frequency MHz	5697
Bandwidth [BW] MHz	5490-5850
Insertion Loss in BW dB max	2.5
Ripple in BW dB max	1.3
Return loss. in BW min.	10
Attenuation[Absolute Value] dB min	50.0 min. @ 5150-5330 MHz
Input Power W max.	1
In/Out Impedance ohm	50

4.3 CHARACTERISTIC CURVE

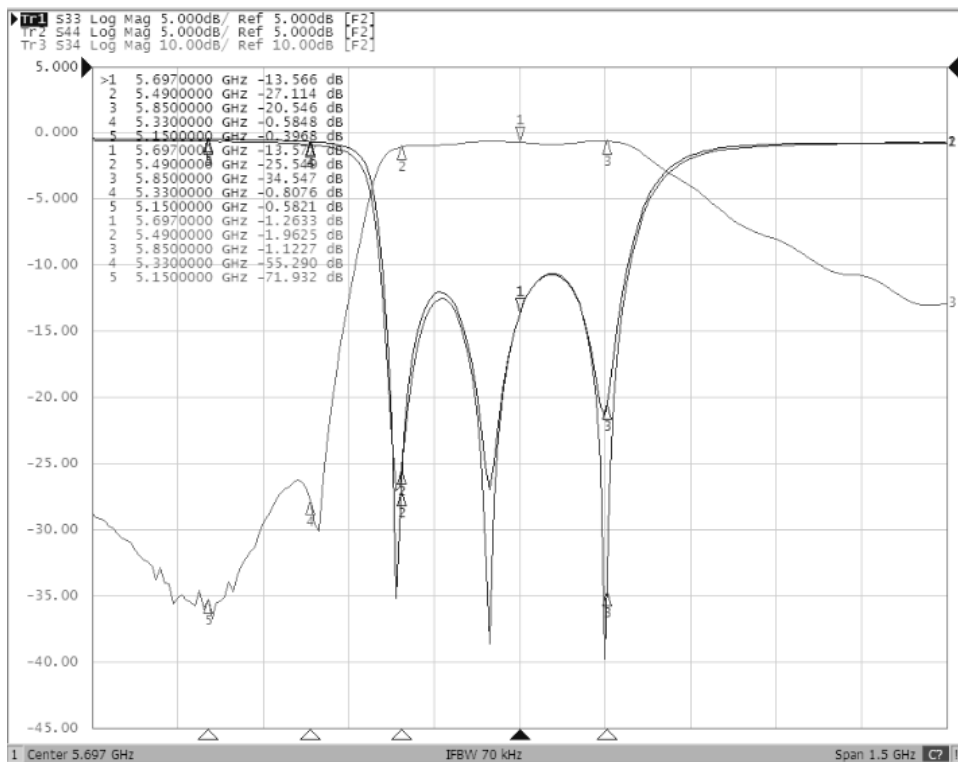

5 ENVIRONMENTAL TESTS

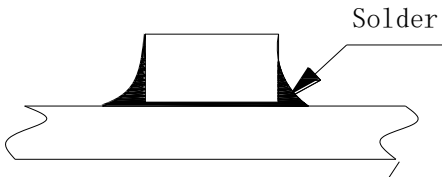
No.	Item	Test Condition	Remark
5.1	Humidity Test	The device is subjected to 90%~95% relative humidity $40^{\circ}\text{C}\pm 2^{\circ}\text{C}$ for 96h~98h, then dry out at $25^{\circ}\text{C}\pm 5^{\circ}\text{C}$ and less than 65% relative humidity for 2h~4h. After dry out the device shall satisfy the specification in table 1.	It shall fulfill the specifications in Table 1.
5.2	High Temperature Exposure	The device shall satisfy the specification in table 1 after leaving at 85°C for 16h, provided it would be measured after 2h~4h leaving in $25^{\circ}\text{C}\pm 5^{\circ}\text{C}$ and less than 65% relative humidity.	It shall fulfill the specifications in Table 1.
5.3	Low Temperature	The device shall satisfy the specification in table 1 after leaving at -40°C for 16h, provided it would be measured after 2h~4h leaving in $25^{\circ}\text{C}\pm 5^{\circ}\text{C}$ and less than 65% relative humidity.	It shall fulfill the specifications in Table 1.
5.4	Temperature Cycle	Subject the device to -25°C for 30 min. followed by a high temperature of 85°C for 30 min cycling shall be repeated 5 times. At the room temperature for 1h~4h prior to the measurement.	It shall fulfill the specifications in Table 1.
5.5	Vibration	Subject the device to vibration for 2h each in x、y and z axis with the amplitude of 1.5mm, the frequency shall be varied uniformly between the limits of 10Hz~55Hz.	It shall fulfill the specifications in Table 1.
5.6	Soldering Test	The device should be satisfied after preheating at $120^{\circ}\text{C}\sim 150^{\circ}\text{C}$ for 60seconds and dipping in soldering Sn an $260^{\circ}\text{C}\pm 5^{\circ}\text{C}$ for 10 ± 1 seconds.	Mechanical damage shall not occur.
5.7	Solder Ability	Dipped in $250^{\circ}\text{C}\pm 5^{\circ}\text{C}$ solder bath for $3\text{s}\pm 0.5\text{s}$ with rosin flux (25wt% ethanol solution.)	The terminals shall be at least 95% covered by solder.
5.8	Terminal Pressure Strength	 <p>The device is subjected to be soldered to be soldered on test PCB .Then apply 5N of force for $10\text{s}\pm 1\text{s}$ in the direction of the arrow.</p>	Mechanical damage such as breaks shall not occur.



ECS Inc. International

Table 1

Item	Characteristics after test
Insertion Loss Change dB max	± 0.3
Ripple dB max	± 0.3
Attenuation Change dB min	± 2.0

Note: The limits in the above table are referenced to the initial measurements.

6. Recommended soldering conditions

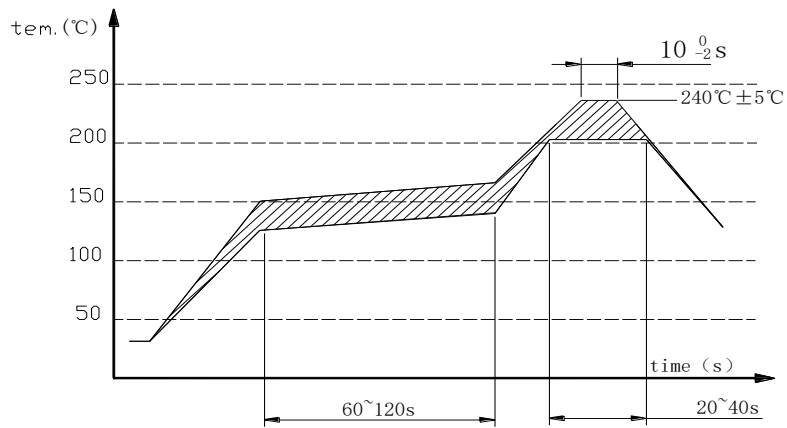

7. Reel Dimensions

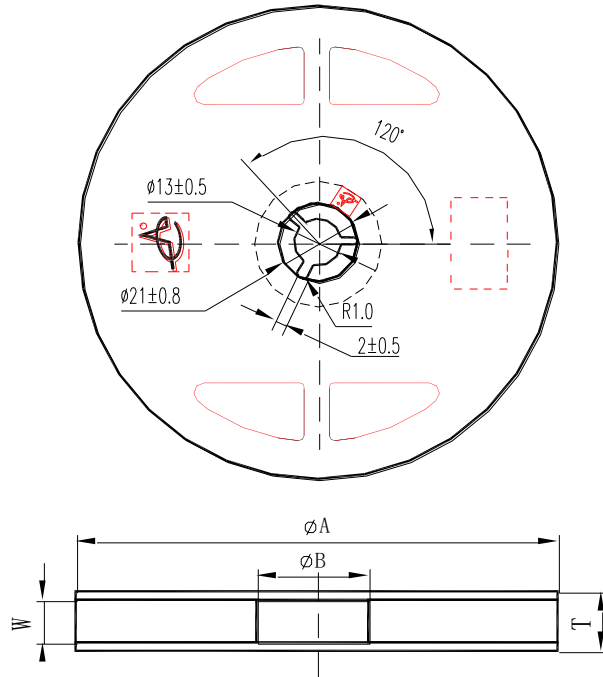

ϕA	ϕB	W	T	Pieces per reel	Carrier tape size
330 ± 3	80min	16.4min	22.4max	2000typ.	16

7.1 Packing Method Sketch Map

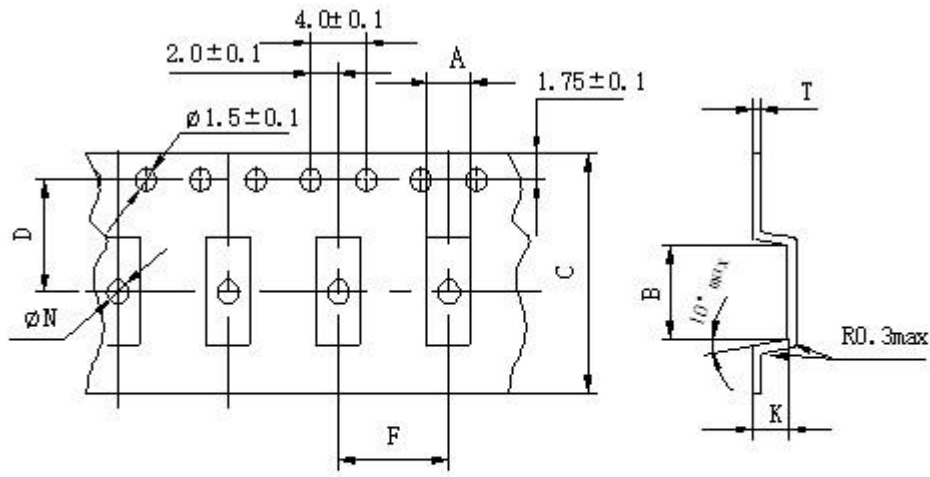

Dimension mark							
A	B	C	D	F	ϕN	K	T
4.6 ± 0.1	9.0 ± 0.2	16.0 ± 0.2	7.5 ± 0.1	8.0 ± 0.1	1.55 ± 0.05	3.3 ± 0.1	0.3 ± 0.05

7.2 Test Condition of Peeling Strength

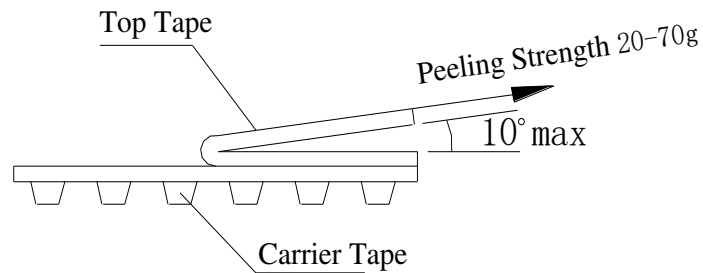

8. OTHER

8.1 Caution

8.1.1 Don't apply excess mechanical stress to the component and terminals at soldering. Do not use this product with bend.

8.1.2 Do not clean or wash the component for it is not hermetically sealed.

8.1.3 Do not use strong acidity flux, more than 0.2wt% chlorine content, in flow soldering.

8.1.4 This specification mentions the quality of the component as a single unit. Please ensure the component is thoroughly evaluated in your application circuit

8.1.5 Expire date (Shelf life) of the products is six months after delivery under the conditions of a sealed and an unopened package. Please use the products within six months after delivery. If you store the products for a long time (more than six months), use carefully because the products may be degraded in the solderability or rusty. Please confirm solderability and characteristics for the products regularly.

8.1.6 Please contact us before using the product as automobile electronic component.

8.2 Notice

8.2.1 Please return one of these specifications after your signature of acceptance.