

## 4 x 40 W multifunction quad power amplifier with built-in diagnostics features

### Features

- DMOS power output
- High output power capability 4 x 25 W/4  $\Omega$  @ 14.4 V, 1 kHz, 10 % THD, 4 x 40 W max. power
- Max. output power 4 x 60 W/2  $\Omega$
- Full I<sup>2</sup>C bus driving:
  - Standby
  - Independent front/rear soft play/mute
  - Selectable gain 26 dB - 12 dB
  - I<sup>2</sup>C bus digital diagnostics
- Full fault protection
- DC offset detection
- Four independent short circuit protection
- Clipping detector pin with selectable threshold (1%, 10%)
- ESD protection

### Description

The TDA7566 is a new BCD technology quad bridge type of car radio amplifier in Flexiwatt25 package specially intended for car radio applications.

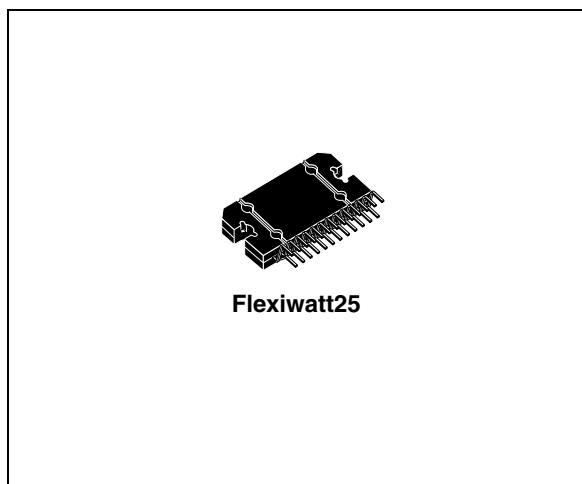

Thanks to the DMOS output stage the TDA7566 has a very low distortion allowing a clear powerful sound.

This device is equipped with a full diagnostics array that communicates the status of each speaker through the I<sup>2</sup>C bus.

The possibility to control the configuration and behavior of the device by means of the I<sup>2</sup>C bus makes TDA7566 a very flexible product.

**Table 1. Device summary**

Order code	Package	Packing
E-TDA7566	Flexiwatt25	Tube
TDA7566 <sup>(1)</sup>	Flexiwatt25	Tube

1. Obsolete product.

# Contents

<b>1</b>	<b>Block diagram and application and test circuit</b> .....	<b>5</b>
1.1	Block diagram .....	5
1.2	Application and test circuit .....	5
<b>2</b>	<b>Pin description</b> .....	<b>6</b>
<b>3</b>	<b>Electrical specifications</b> .....	<b>7</b>
3.1	Absolute maximum ratings .....	7
3.2	Thermal data .....	7
3.3	Electrical characteristics .....	7
3.4	Electrical characteristics curves .....	10
<b>4</b>	<b>Diagnostics functional description</b> .....	<b>12</b>
4.1	Turn-on diagnostic .....	12
4.2	Permanent diagnostics .....	14
4.3	Output DC offset detection .....	15
4.4	AC diagnostic .....	16
4.5	Multiple faults .....	17
4.6	Faults availability .....	17
4.7	I2C programming/reading sequence .....	18
<b>5</b>	<b>I2C bus interface</b> .....	<b>19</b>
5.1	Data validity .....	19
5.2	Start and stop conditions .....	19
5.3	Byte format .....	19
5.4	Acknowledge .....	19
<b>6</b>	<b>Software specifications</b> .....	<b>21</b>
<b>7</b>	<b>Examples of bytes sequence</b> .....	<b>26</b>
<b>8</b>	<b>Package information</b> .....	<b>27</b>
<b>9</b>	<b>Revision history</b> .....	<b>28</b>

## List of tables

Table 1.	Device summary . . . . .	1
Table 2.	Absolute maximum ratings . . . . .	7
Table 3.	Thermal data . . . . .	7
Table 4.	Electrical characteristics . . . . .	7
Table 5.	Double fault table for turn-on diagnostic . . . . .	17
Table 6.	IB1 . . . . .	21
Table 7.	IB2 . . . . .	22
Table 8.	DB1 . . . . .	22
Table 9.	DB2 . . . . .	23
Table 10.	DB3 . . . . .	24
Table 11.	DB4 . . . . .	25
Table 12.	Document revision history . . . . .	28

## List of figures

Figure 1.	Block diagram . . . . .	5
Figure 2.	Application and test circuit . . . . .	5
Figure 3.	Pin connection (top view) . . . . .	6
Figure 4.	Quiescent current vs. supply voltage . . . . .	10
Figure 5.	Output power vs. supply voltage (4 $\Omega$ ) . . . . .	10
Figure 6.	Output power vs. supply voltage (2 $\Omega$ ) . . . . .	10
Figure 7.	Distortion vs. output power (4 $\Omega$ ) . . . . .	10
Figure 8.	Distortion vs. output power (2 $\Omega$ ) . . . . .	10
Figure 9.	Distortion vs. frequency (4 $\Omega$ ) . . . . .	10
Figure 10.	Distortion vs. frequency (2 $\Omega$ ) . . . . .	11
Figure 11.	Crosstalk vs. frequency . . . . .	11
Figure 12.	Supply voltage rejection vs. frequency . . . . .	11
Figure 13.	Power dissipation and efficiency vs. output power (4 W, Sine) . . . . .	11
Figure 14.	Power dissipation vs. average output power (audio program simulation, 4 W) . . . . .	11
Figure 15.	Power dissipation vs. average output power (audio program simulation, 2 W) . . . . .	11
Figure 16.	Turn - on diagnostic: working principle . . . . .	12
Figure 17.	SVR and output behavior (case 1: without turn-on diagnostic) . . . . .	13
Figure 18.	SVR and output pin behavior (case 2: with turn-on diagnostic) . . . . .	13
Figure 19.	Thresholds for short to GND/ $V_S$ . . . . .	13
Figure 20.	Thresholds for short across the speaker/open speaker . . . . .	14
Figure 21.	Thresholds for line-drivers . . . . .	14
Figure 22.	Restart timing without diagnostic enable (Permanent) . . . . .	15
Figure 23.	Restart timing with diagnostic enable (Permanent) . . . . .	15
Figure 24.	Current detection: load impedance magnitude $ Z $ vs. output peak voltage of the sinus. . . . .	16
Figure 25.	Data validity on the I <sup>2</sup> C bus . . . . .	19
Figure 26.	Timing diagram on the I <sup>2</sup> C bus . . . . .	20
Figure 27.	Timing acknowledge clock pulse . . . . .	20
Figure 28.	Flexiwatt25 mechanical data and package dimensions . . . . .	27

# 1 Block diagram and application and test circuit

## 1.1 Block diagram

Figure 1. Block diagram

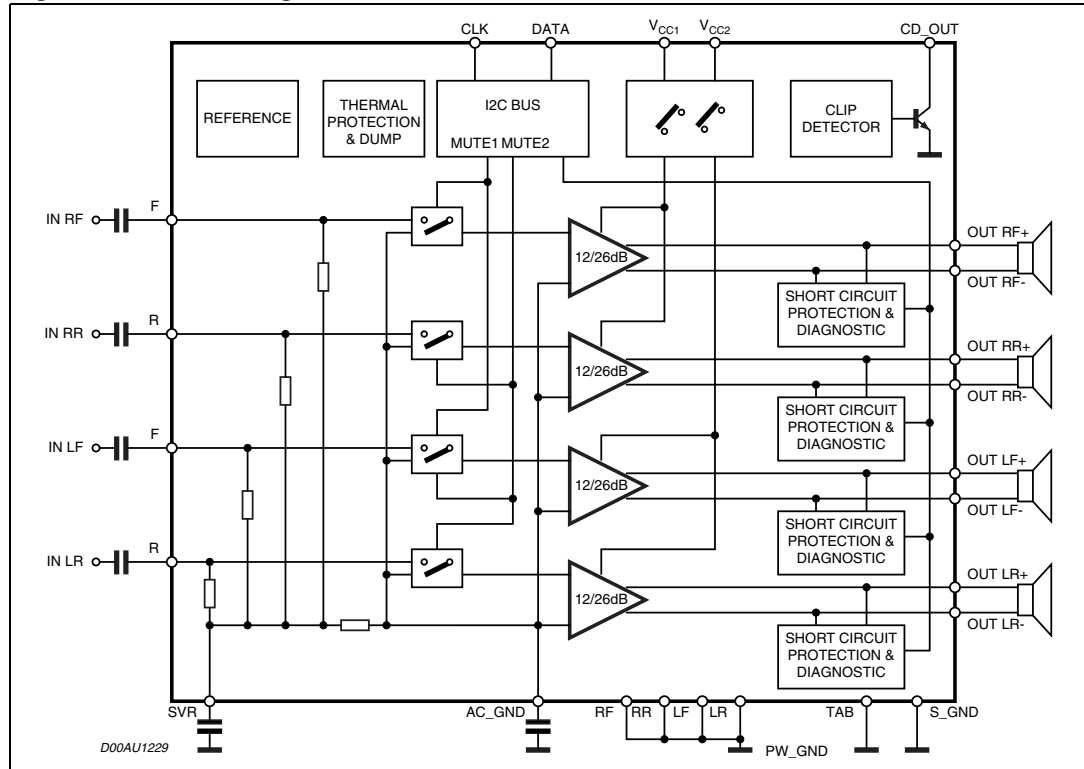

## 1.2 Application and test circuit

Figure 2. Application and test circuit

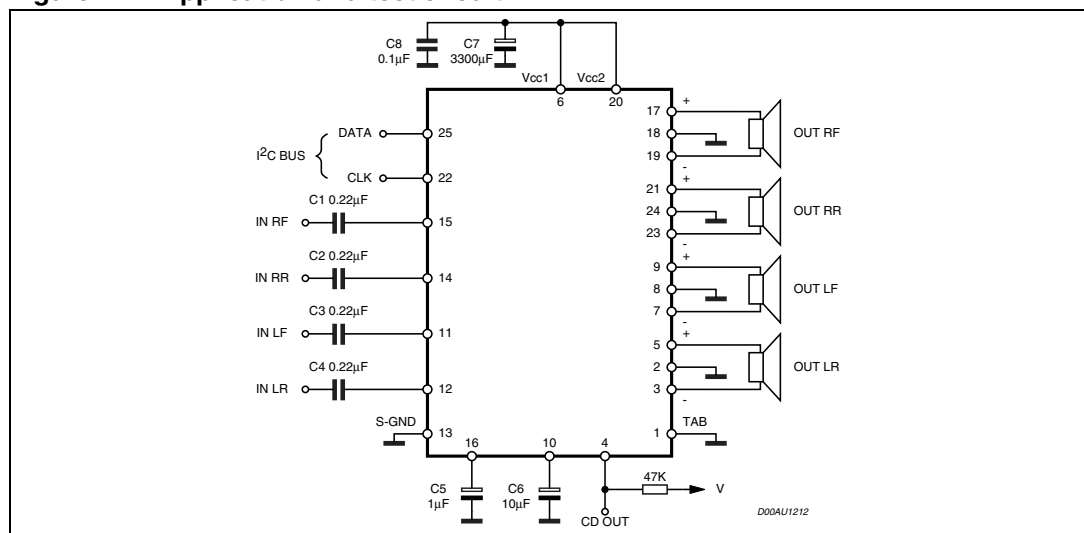

## 2 Pin description

Figure 3. Pin connection (top view)

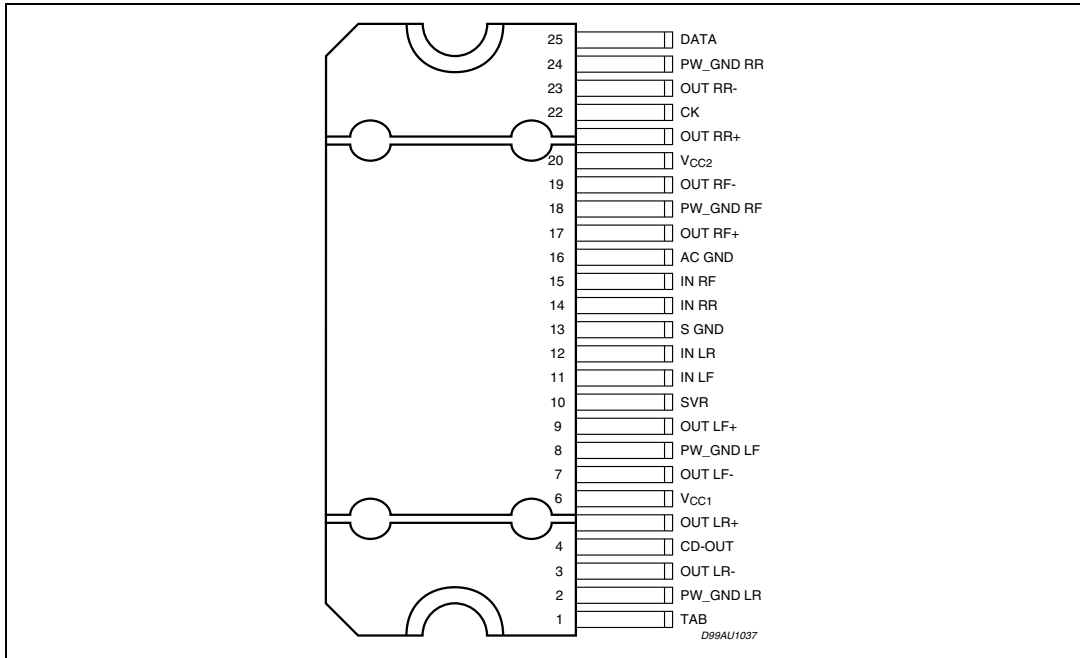

### 3 Electrical specifications

#### 3.1 Absolute maximum ratings

Table 2. Absolute maximum ratings

Symbol	Parameter	Value	Unit
$V_{op}$	Operating supply voltage	18	V
$V_S$	DC supply voltage	28	V
$V_{peak}$	Peak supply voltage (for $t = 50$ ms)	50	V
$V_{CK}$	CK pin voltage	6	V
$V_{DATA}$	Data pin voltage	6	V
$I_O$	Output peak current (not repetitive $t = 100$ $\mu$ s)	8	A
$I_O$	Output peak current (repetitive $f > 10$ Hz)	6	A
$P_{tot}$	Power dissipation $T_{case} = 70$ °C	85	W
$T_{stg}, T_j$	Storage and junction temperature	-55 to 150	°C

#### 3.2 Thermal data

Table 3. Thermal data

Symbol	Description	Value	Unit
$R_{th\ j-case}$	Thermal resistance junction-to-case	Max. 1	°C/W

#### 3.3 Electrical characteristics

Table 4. Electrical characteristics

(Refer to the test circuit,  $V_S = 14.4$  V;  $R_L = 4$   $\Omega$ ;  $f = 1$  kHz;  $G_V = 26$  dB;  $T_{amb} = 25$  °C; unless otherwise specified.)

Symbol	Parameter	Test condition	Min.	Typ.	Max.	Unit
<b>Power amplifier</b>						
$V_S$	Supply voltage range	-	8	-	18	V
$I_d$	Total quiescent drain current	-	-	150	300	mA
$P_O$	Output power	Max. ( $V_S = 14.4$ V)	35	40	-	W
		THD = 10 %	22	25	-	W
		THD = 1 %	16	20	-	W
		$R_L = 2$ $\Omega$ ; EIAJ ( $V_S = 13.7$ V)	50	55	-	W
		$R_L = 2$ $\Omega$ ; THD 10 %	32	38	-	W
		$R_L = 2$ $\Omega$ ; THD 1 %	25	30	-	W
		$R_L = 2$ $\Omega$ ; MAX POWER	55	60	-	W

**Table 4. Electrical characteristics (continued)**

(Refer to the test circuit,  $V_S = 14.4\text{ V}$ ;  $R_L = 4\ \Omega$ ;  $f = 1\text{ kHz}$ ;  $G_V = 26\text{ dB}$ ;  $T_{amb} = 25\text{ }^\circ\text{C}$ ; unless otherwise specified.)

Symbol	Parameter	Test condition	Min.	Typ.	Max.	Unit
THD	Total harmonic distortion	$P_O = 1\text{ W to }10\text{ W}$	-	0.04	0.1	%
		$G_V = 12\text{ dB}$ ; $V_O = 0.1\text{ to }5\text{ V}_{RMS}$	-	0.02	0.05	%
$C_T$	Cross talk	$f = 1\text{ kHz to }10\text{ kHz}$ , $R_G = 600\ \Omega$	50	60	-	dB
$R_{IN}$	Input impedance	-	60	100	130	$K\Omega$
$G_{V1}$	Voltage gain 1	-	25	26	27	dB
$\Delta G_{V1}$	Voltage gain match 1	-	-1	0	1	dB
$G_{V2}$	Voltage gain 2	-	-	12	-	dB
$E_{IN1}$	Output noise voltage 1	$R_g = 600\ \Omega$ ; 20 Hz to 22 kHz	-	35	100	$\mu\text{V}$
$E_{IN2}$	Output noise voltage 2	$R_g = 600\ \Omega$ ; $G_V = 12\text{ dB}$ ; 20 Hz to 22 kHz	-	12	-	$\mu\text{V}$
SVR	Supply voltage rejection	$f = 100\text{ Hz to }10\text{ kHz}$ ; $V_r = 1\text{ V pk}$ ; $R_g = 600\ \Omega$	50	60	-	dB
BW	Power bandwidth	-	100	-	-	KHz
$A_{SB}$	Standby attenuation	-	90	110	-	dB
$I_{SB}$	Standby current	-	-	25	100	$\mu\text{A}$
$A_M$	Mute attenuation	-	80	100	-	dB
$V_{OS}$	Offset voltage	Mute and Play	-100	0	100	mV
$V_{AM}$	Min. supply voltage threshold	-	7	7.5	8	V
$T_{ON}$	Turn on delay	D2/D1 (IB1) 0 to 1	-	20	50	ms
$T_{OFF}$	Turn off delay	D2/D1 (IB1) 1 to 0	-	20	50	ms
$CD_{LK}$	Clip det high leakage current	CD off	-	0	15	$\mu\text{A}$
$CD_{SAT}$	Clip det sat. voltage	CD on; $I_{CD} = 1\text{ mA}$	-	-	300	mV
$CD_{THD}$	Clip det THD level	D0 (IB1) = 0	0	1	2	%
		D0 (IB1) = 1	5	10	15	%
<b>Turn on diagnostics 1 (Power amplifier mode)</b>						
$P_{gnd}$	Short to GND det. (below this limit, the Output is considered in Short Circuit to GND)	Power amplifier in standby	-	-	1.2	V
$P_{vs}$	Short to Vs det. (above this limit, the Output is considered in Short Circuit to VS)		$V_S - 1.2$	-	-	V
$P_{nop}$	Normal operation thresholds. (Within these limits, the Output is considered without faults).		1.8	-	$V_S - 1.8$	V



**Table 4. Electrical characteristics (continued)**

(Refer to the test circuit,  $V_S = 14.4\text{ V}$ ;  $R_L = 4\ \Omega$ ;  $f = 1\text{ kHz}$ ;  $G_V = 26\text{ dB}$ ;  $T_{\text{amb}} = 25\text{ }^\circ\text{C}$ ; unless otherwise specified.)

Symbol	Parameter	Test condition	Min.	Typ.	Max.	Unit
Lsc	Shorted load det.	-	-	-	0.5	$\Omega$
Lop	Open load det.	-	85	-	-	$\Omega$
Lnop	Normal load det.	-	1.65	-	45	$\Omega$
<b>Turn on diagnostics 2 (Line driver mode)</b>						
Pgnd	Short to GND det. (below this limit, the Output is considered in Short Circuit to GND)	Power amplifier in standby	-	-	1.2	V
Pvs	Short to Vs det. (above this limit, the Output is considered in Short Circuit to VS)		Vs -1.2	-	-	V
Pnop	Normal operation thresholds. (Within these limits, the Output is considered without faults).		1.8	-	Vs -1.8	V
Lsc	Shorted load det.	-	-	-	2	$\Omega$
Lop	Open load det.	-	330	-	-	$\Omega$
Lnop	Normal load det.	-	7	-	180	$\Omega$
<b>Permanent diagnostics 2 (Power amplifier mode or line driver mode)</b>						
Pgnd	Short to GND det. (below this limit, the Output is considered in Short Circuit to GND)	Power amplifier in Mute or Play, one or more short circuits protection activated	-	-	1.2	V
Pvs	Short to Vs det. (above this limit, the Output is considered in Short Circuit to VS)	-	Vs -1.2	-	-	V
Pnop	Normal operation thresholds. (Within these limits, the Output is considered without faults).	-	1.8	-	Vs -1.8	V
L <sub>SC</sub>	Shorter Load det.	Power amplifier mode	-	-	0.5	$\Omega$
		Line driver mode	-	-	2	$\Omega$
V <sub>O</sub>	Offset Detection	Power amplifier in play, AC Input signals = 0	1.5	2	2.5	V
I <sub>NL</sub>	Normal load current detection	$V_O < (V_S - 5)\text{pk}$	500	-	-	mA
I <sub>OL</sub>	Open load current detection		-	-	250	mA
<b>I<sup>2</sup>C bus interface</b>						
f <sub>SCL</sub>	Clock frequency	-	-	400	-	KHz
V <sub>IL</sub>	Input low voltage	-	-	-	1.5	V
V <sub>IH</sub>	Input high voltage	-	2.3	-	-	V

### 3.4 Electrical characteristics curves

**Figure 4. Quiescent current vs. supply voltage**

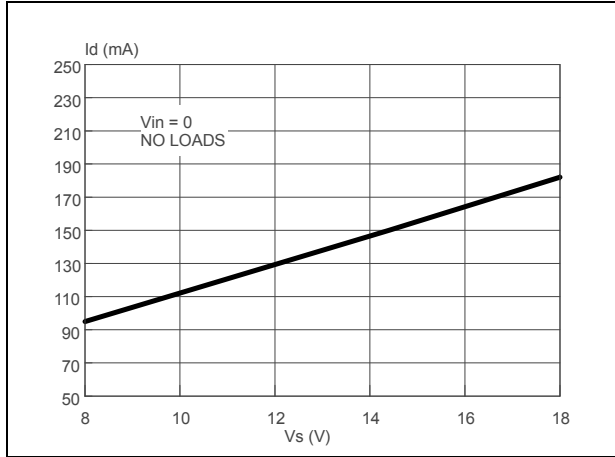

**Figure 5. Output power vs. supply voltage (4 Ω)**

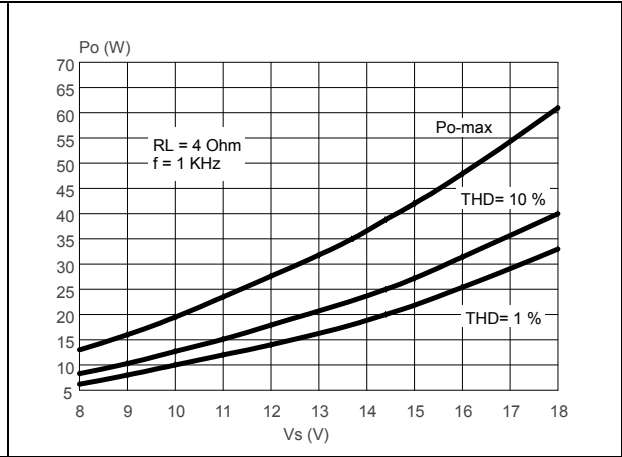

**Figure 6. Output power vs. supply voltage (2 Ω)**

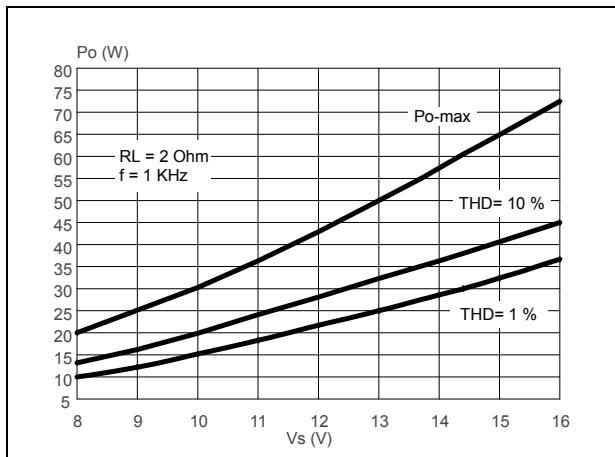

**Figure 7. Distortion vs. output power (4 Ω)**

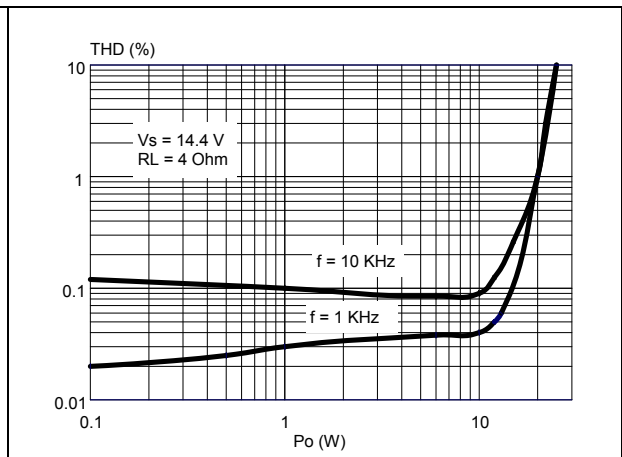

**Figure 8. Distortion vs. output power (2 Ω)**

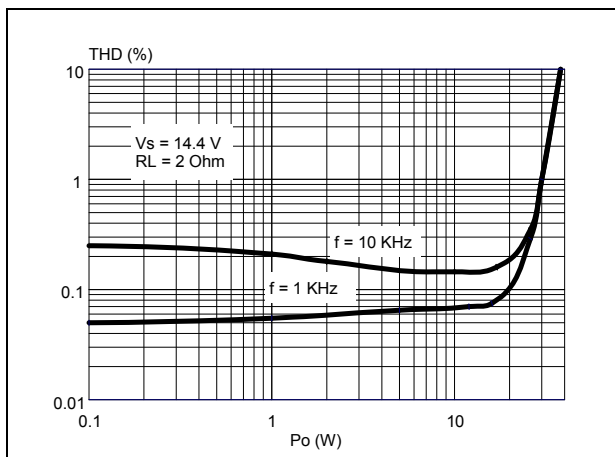

**Figure 9. Distortion vs. frequency (4 Ω)**

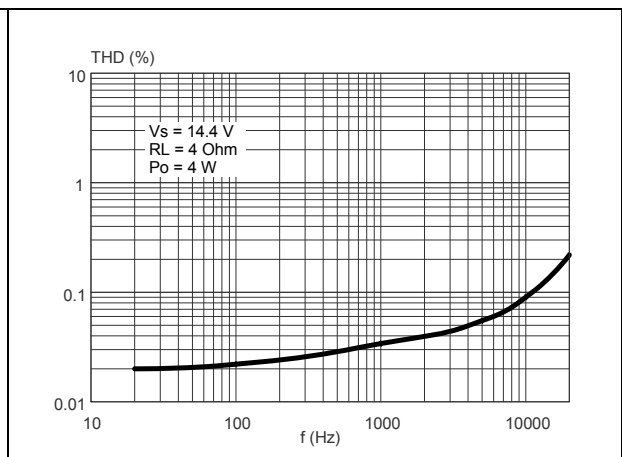

Figure 10. Distortion vs. frequency (2 Ω)

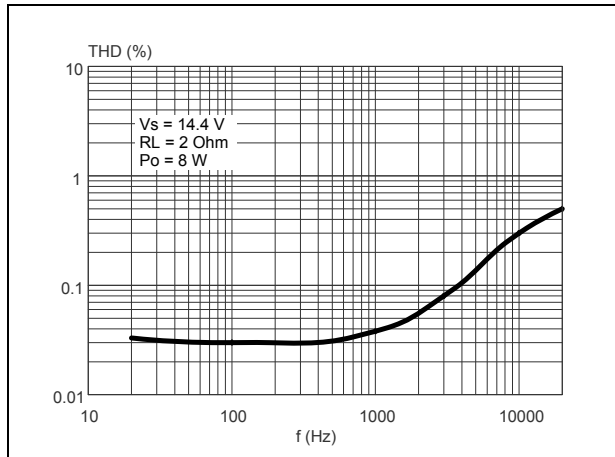

Figure 11. Crosstalk vs. frequency

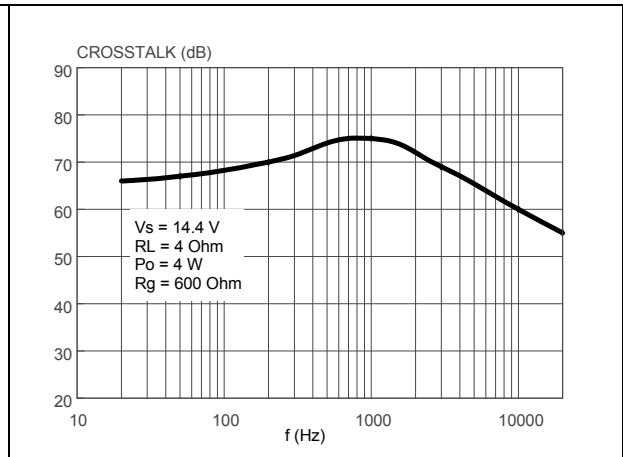

Figure 12. Supply voltage rejection vs. frequency

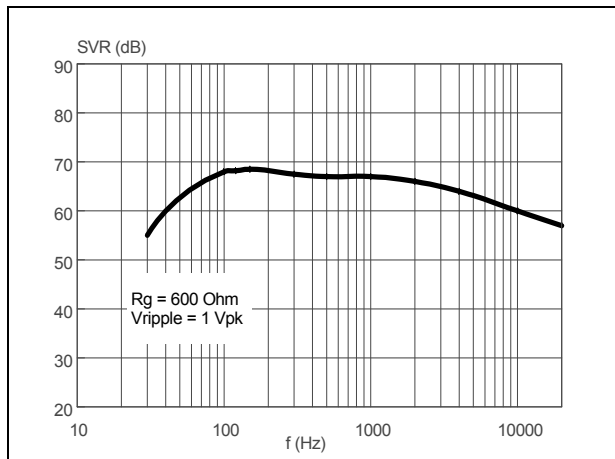

Figure 13. Power dissipation and efficiency vs. output power (4 Ω, Sine)

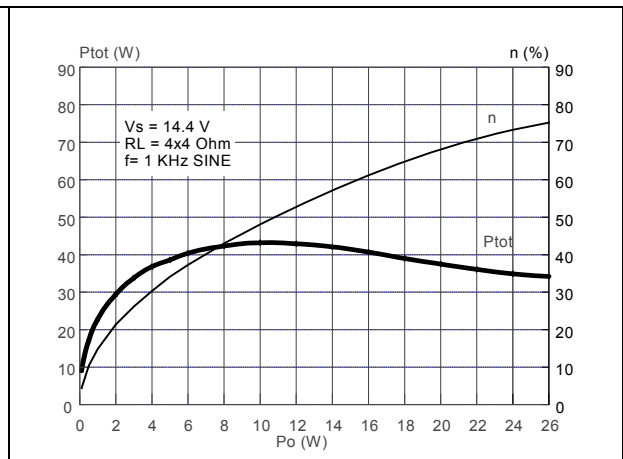

Figure 14. Power dissipation vs. average output power (audio program simulation, 4 Ω)

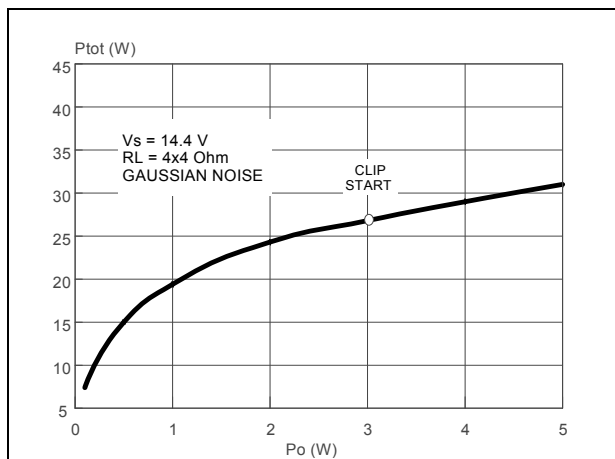
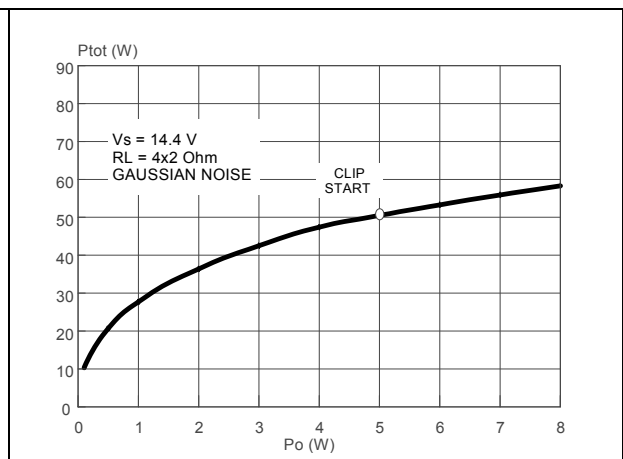

Figure 15. Power dissipation vs. average output power (audio program simulation, 2 Ω)



## 4 Diagnostics functional description

### 4.1 Turn-on diagnostic

It is activated at the turn-on (standby out) under I<sup>2</sup>C bus request. Detectable output faults are:

- Short to GND
- Short to V<sub>S</sub>
- Short across the speaker
- Open speaker

To verify if any of the above misconnections are in place, a subsonic (inaudible) current pulse ([Figure 16](#)) is internally generated, sent through the speaker(s) and sunk back. The Turn On diagnostic status is internally stored until a successive diagnostic pulse is requested (after a I<sup>2</sup>C reading).

If the "standby out" and "diag. enable" commands are both given through a single programming step, the pulse takes place first (power stage still in standby mode, low, outputs = high impedance).

Afterwards, when the Amplifier is biased, the PERMANENT diagnostic takes place. The previous Turn On state is kept until a short appears at the outputs.

**Figure 16. Turn-on diagnostic: working principle**

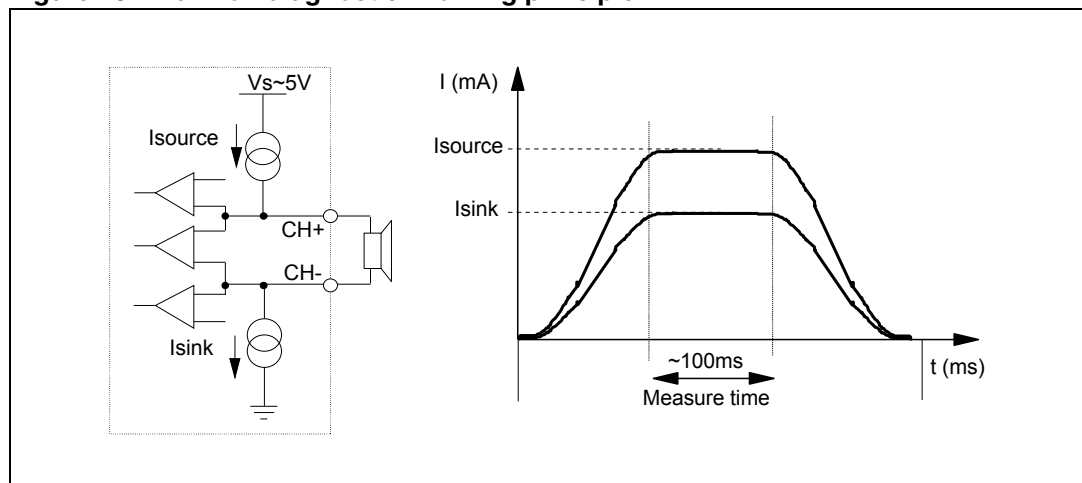

[Figure 17](#) and [18](#) show SVR and output waveforms at the turn-on (standby out) with and without Turn-on diagnostic.

Figure 17. SVR and output behavior (case 1: without turn-on diagnostic)

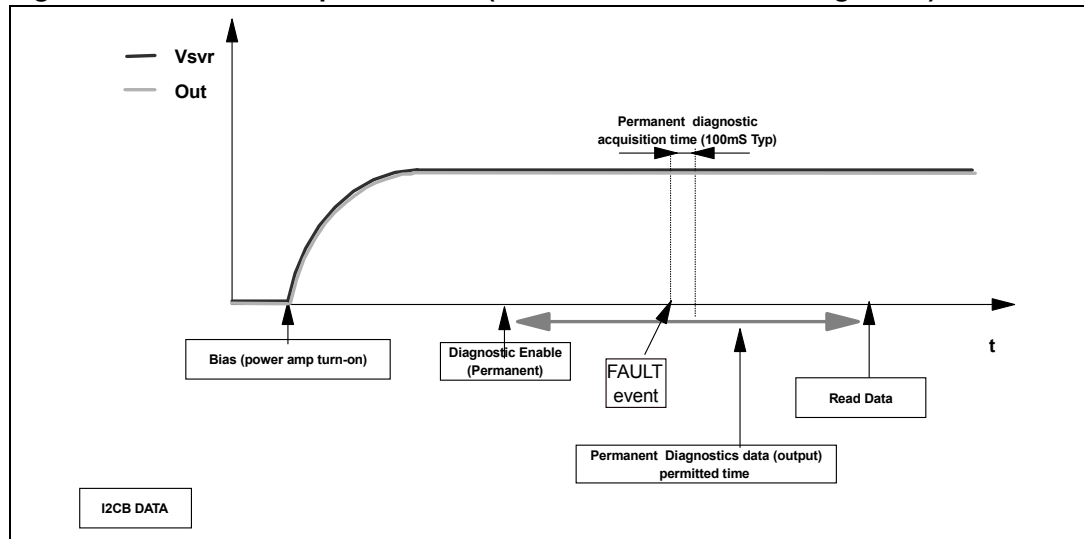
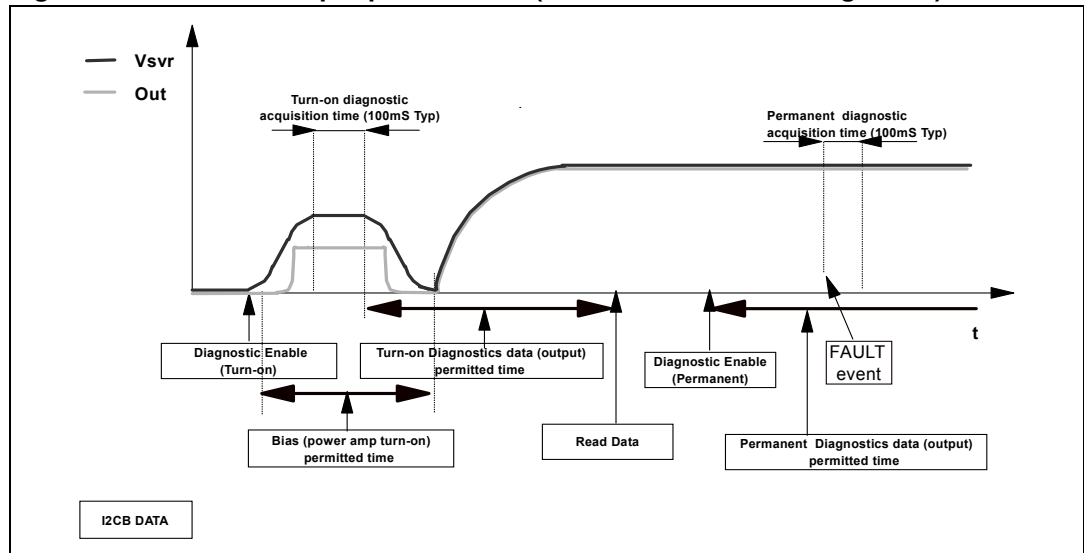
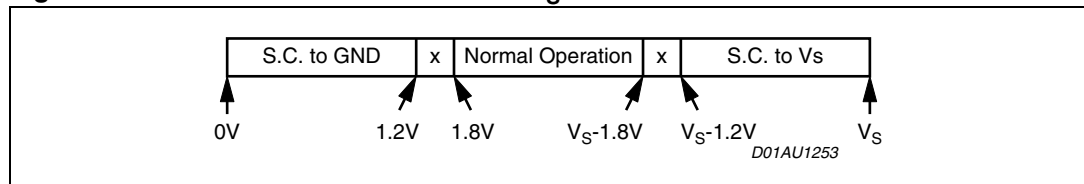

Figure 18. SVR and output pin behavior (case 2: with turn-on diagnostic)



The information related to the outputs status is read and memorized at the end of the current pulse top. The acquisition time is 100 ms (typ.). No audible noise is generated in the process. As for short to GND / Vs the fault-detection thresholds remain unchanged from 26 dB to 12 dB gain setting. They are as follows:

Figure 19. Thresholds for short to GND/Vs



Concerning short across the speaker / open speaker, the threshold varies from 26 dB to 12 dB gain setting, since different loads are expected (either normal speaker's impedance or high impedance). The values in case of 26 dB gain are as follows:

**Figure 20. Thresholds for short across the speaker/open speaker**

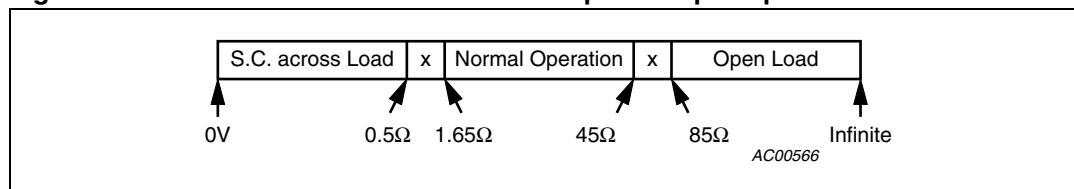

If the Line-Driver mode ( $G_V = 12$  dB and Line Driver Mode diagnostic = 1) is selected, the same thresholds will change as follows:

**Figure 21. Thresholds for line-drivers**

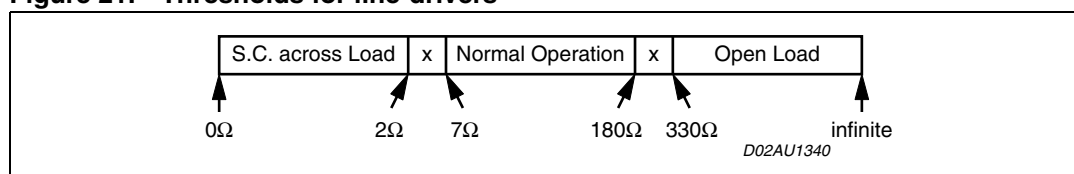

## 4.2 Permanent diagnostics

Detectable conventional faults are:

- short to GND
- short to  $V_s$
- short across the speaker

The following additional features are provided:

- output offset detection
- AC diagnostic

The TDA7566 has 2 operating statuses:

1. Restart mode. The diagnostic is not enabled. Each audio channel operates independently from each other. If any of the a.m. faults occurs, only the channel(s) interested is shut down. A check of the output status is made every 1 ms ([Figure 22](#)). Restart takes place when the overload is removed.
2. Diagnostic mode. It is enabled via I<sup>2</sup>C bus and self activates if an output overload (such to cause the intervention of the short-circuit protection) occurs to the speakers outputs. Once activated, the diagnostics procedure develops as follows ([Figure 23](#)):
  - To avoid momentary re-circulation spikes from giving erroneous diagnostics, a check of the output status is made after 1ms: if normal situation (no overloads) is detected, the diagnostic is not performed and the channel returns back active.
  - Instead, if an overload is detected during the check after 1 ms, then a diagnostic cycle having a duration of about 100 ms is started.
  - After a diagnostic cycle, the audio channel interested by the fault is switched to Restart mode. The relevant data are stored inside the device and can be read by the microprocessor. When one cycle has terminated, the next one is activated by

an I<sup>2</sup>C reading. This is to ensure continuous diagnostics throughout the car-radio operating time.

- To check the status of the device a sampling system is needed. The timing is chosen at microprocessor level (over half a second is recommended).

**Figure 22. Restart timing without diagnostic enable (Permanent)**  
each 1 ms time, a sampling of the fault is done

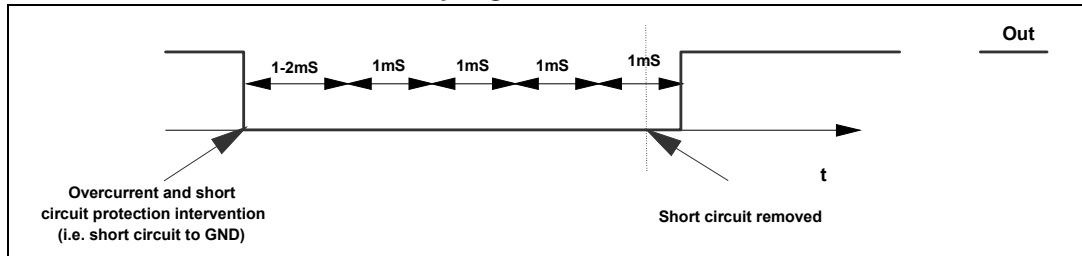

**Figure 23. Restart timing with diagnostic enable (Permanent)**

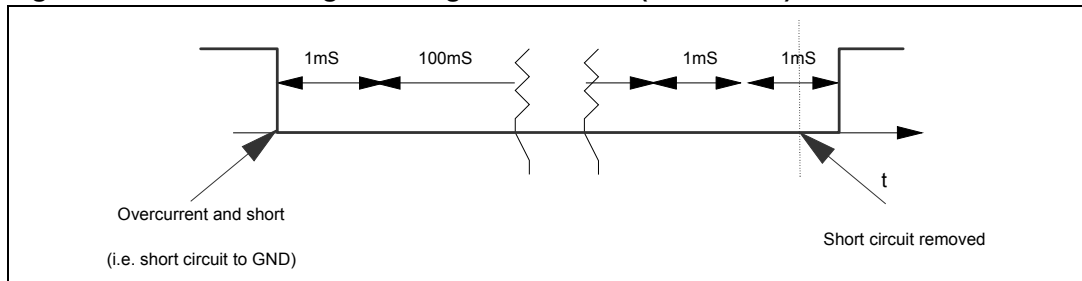

### 4.3 Output DC offset detection

Any DC output offset exceeding  $\pm 2$  V are signalled out. This inconvenient might occur as a consequence of initially defective or aged and worn-out input capacitors feeding a DC component to the inputs, so putting the speakers at risk of overheating.

This diagnostic has to be performed with low-level output AC signal (or  $V_{in} = 0$ ).

The test is run with selectable time duration by microprocessor (from a "start" to a "stop" command):

START = Last reading operation or setting IB1 - D5 - (OFFSET enable) to 1

STOP = Actual reading operation

Excess offset is signalled out if persistent throughout the assigned testing time. This feature is disabled if any overloads leading to activation of the short-circuit protection occurs in the process.

### 4.4 AC diagnostic

It is targeted at detecting accidental disconnection of tweeters in 2-way speaker and, more in general, presence of capacitive (AC) coupled loads.

This diagnostic is based on the notion that the overall speaker's impedance (woofer + parallel tweeter) will tend to increase towards high frequencies if the tweeter gets disconnected, because the remaining speaker (woofer) would be out of its operating range (high impedance). The diagnostic decision is made according to peak output current thresholds, as follows:

$$I_{out} > 500\text{mA} = \text{normal status}$$

$$I_{out} < 250\text{mA} = \text{open tweeter}$$

To correctly implement this feature, it is necessary to briefly provide a signal tone (with the amplifier in "play") whose frequency and magnitude are such to determine an output current higher than 500mA in normal conditions and lower than 250mA should the parallel tweeter be missing. The test has to last for a minimum number of 3 sine cycles starting from the activation of the AC diagnostic function (IB2<D2>) up to the I<sup>2</sup>C reading of the results (measuring period). To confirm presence of tweeter, it is necessary to find at least 3 current pulses over 500mA over all the measuring period, else an "open tweeter" message will be issued.

The frequency / magnitude setting of the test tone depends on the impedance characteristics of each specific speaker being used, with or without the tweeter connected (to be calculated case by case). High-frequency tones (> 10 KHz) or even ultrasonic signals are recommended for their negligible acoustic impact and also to maximize the impedance module's ratio between with tweeter-on and tweeter-off.

Figure 24 shows the Load Impedance as a function of the peak output voltage and the relevant diagnostic fields.

This feature is disabled if any overloads leading to activation of the short-circuit protection occurs in the process.

**Figure 24. Current detection: load impedance magnitude |Z| vs. output peak voltage of the sinus**

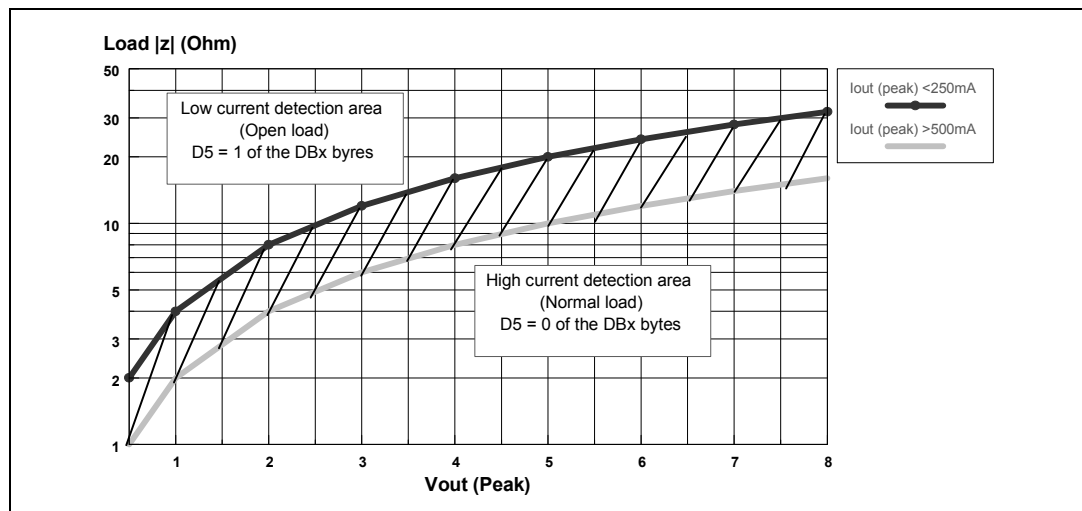



## 4.5 Multiple faults

When more misconnections are simultaneously in place at the audio outputs, it is guaranteed that at least one of them is initially read out. The others are notified after successive cycles of I<sup>2</sup>C reading and faults removal, provided that the diagnostic is enabled. This is true for both kinds of diagnostic (Turn on and Permanent).

The table below shows all the couples of double-fault possible. It should be taken into account that a short circuit with the 4 ohm speaker unconnected is considered as double fault.

**Table 5. Double fault table for turn-on diagnostic**

	S. GND (so)	S. GND (sk)	S. Vs	S. Across L.	Open L.
S. GND (so)	S. GND	S. GND	S. Vs + S. GND	S. GND	S. GND
S. GND (sk)	/	S. GND	S. Vs	S. GND	Open L. (*)
S. Vs	/	/	S. Vs	S. Vs	S. Vs
S. Across L.	/	/	/	S. Across L.	N.A.
Open L.	/	/	/	/	Open L. (*)

S. GND (so) / S. GND (sk) in the above table make a distinction according to which of the 2 outputs is shorted to ground (test-current source side = so, test-current sink side = sk). More precisely, in channels LF and LR, so = CH+, sk = CH-; in channels LR and RF, so = CH-, SK = CH+.

In Permanent Diagnostic the table is the same, with only a difference concerning Open Load (\*), which is not among the recognizable faults. Should an Open Load be present during the device's normal working, it would be detected at a subsequent Turn-on Diagnostic cycle (i.e. at the successive Car Radio Turn-on).

## 4.6 Faults availability

All the results coming from I<sup>2</sup>C bus, by read operations, are the consequence of measurements inside a defined period of time. If the fault is stable throughout the whole period, it will be sent out. This is true for DC diagnostic (Turn-on and Permanent), for Offset Detector, for AC Diagnostic (the low current sensor needs to be stable to confirm the Open tweeter).

To guarantee always resident functions, every kind of diagnostic cycles (Turn on, Permanent, Offset, AC) will be reactivate after any I<sup>2</sup>C reading operation. So, when the micro reads the I<sup>2</sup>C, a new cycle will be able to start, but the read data will come from the previous diag. cycle (i.e. The device is in Turn On state, with a short to Gnd, then the short is removed and micro reads I<sup>2</sup>C. The short to GND is still present in bytes, because it is the result of the previous cycle. If another I<sup>2</sup>C reading operation occurs, the bytes do not show the short). In general to observe a change in Diagnostic bytes, two I<sup>2</sup>C reading operations are necessary.

## 4.7 I<sup>2</sup>C programming/reading sequence

A correct turn on/off sequence respectful of the diagnostic timings and producing no audible noises could be as follows (after battery connection):

TURN-ON: (STANDBY OUT + DIAG ENABLE) --- 500 ms (min) --- MUTING OUT

TURN-OFF: MUTING IN --- 20 ms --- (DIAG DISABLE + STANDBY IN)

Car Radio Installation: DIAG ENABLE (write) --- 200 ms --- I<sup>2</sup>C read (repeat until All faults disappear).

AC TEST: FEED H.F. TONE -- AC DIAG ENABLE (write) --- WAIT > 3 CYCLES --- I<sup>2</sup>C read (repeat I<sup>2</sup>C reading until tweeter-off message disappears).

OFFSET TEST: Device in Play (no signal) -- OFFSET ENABLE - 30ms - I<sup>2</sup>C reading (repeat I<sup>2</sup>C reading until high-offset message disappears).

## 5 I<sup>2</sup>C bus interface

Data transmission from microprocessor to the TDA7566 and vice versa takes place through the 2 wires I<sup>2</sup>C BUS interface, consisting of the two lines SDA and SCL (pull-up resistors to positive supply voltage must be connected).

### 5.1 Data validity

As shown by [Figure 25](#), the data on the SDA line must be stable during the high period of the clock.

The HIGH and LOW state of the data line can only change when the clock signal on the SCL line is LOW.

### 5.2 Start and stop conditions

As shown by [Figure 26](#) a start condition is a HIGH to LOW transition of the SDA line while SCL is HIGH.

The stop condition is a LOW to HIGH transition of the SDA line while SCL is HIGH.

### 5.3 Byte format

Every byte transferred to the SDA line must contain 8 bits. Each byte must be followed by an acknowledge bit. The MSB is transferred first.

### 5.4 Acknowledge

The transmitter\* puts a resistive HIGH level on the SDA line during the acknowledge clock pulse (see [Figure 27](#)). The receiver\*\* the acknowledges has to pull-down (LOW) the SDA line during the acknowledge clock pulse, so that the SDA line is stable LOW during this clock pulse.

\* Transmitter

- master ( $\mu$ P) when it writes an address to the TDA7566
- slave (TDA7566) when the  $\mu$ P reads a data byte from TDA7566

\*\* Receiver

- slave (TDA7566) when the  $\mu$ P writes an address to the TDA7566
- master ( $\mu$ P) when it reads a data byte from TDA7566

**Figure 25. Data validity on the I<sup>2</sup>C bus**

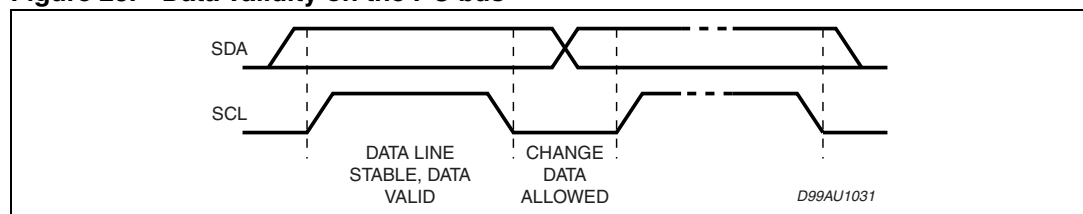

Figure 26. Timing diagram on the I<sup>2</sup>C bus

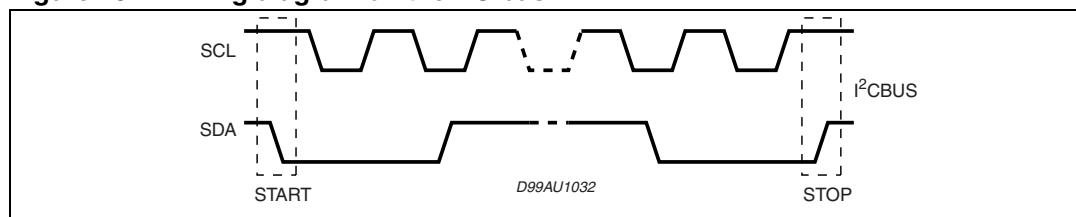
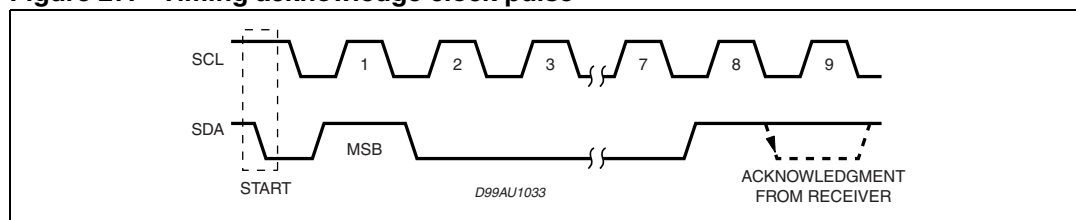

Figure 27. Timing acknowledge clock pulse



## 6 Software specifications

All the functions of the TDA7566 are activated by I<sup>2</sup>C interface.

The bit 0 of the "ADDRESS BYTE" defines if the next bytes are write instruction (from  $\mu$ P to TDA7566) or read instruction (from TDA7566 to  $\mu$ P).

### Chip address

<b>D7</b>							<b>D0</b>	
1	1	0	1	1	0	0	X	D8 Hex

X = 0 Write to device

X = 1 Read from device

If R/W = 0, the  $\mu$ P sends 2 "Instruction Bytes": IB1 and IB2.

**Table 6. IB1**

Bit	Instruction decoding bit
D7	0
D6	Diagnostic enable (D6 = 1) Diagnostic defeat (D6 = 0)
D5	Offset Detection enable (D5 = 1) Offset Detection defeat (D5 = 0)
D4	Front Channel Gain = 26dB (D4 = 0) Gain = 12dB (D4 = 1)
D3	Rear Channel Gain = 26dB (D3 = 0) Gain = 12dB (D3 = 1)
D2	Mute front channels (D2 = 0) Unmute front channels (D2 = 1)
D1	Mute rear channels (D1 = 0) Unmute rear channels (D1 = 1)
D0	CD 2% (D0 = 0) CD 10% (D0 = 1)

**Table 7. IB2**

Bit	Instruction decoding bit
D7	0
D6	0
D5	0
D4	Standby on - Amplifier not working - (D4 = 0) Standby off - Amplifier working - (D4 = 1)
D3	Power amplifier mode diagnostic (D3 = 0) Line driver mode diagnostic (D3 = 1)
D2	Current detection diagnostic enabled (D2 = 1) Current detection diagnostic defeat (D2 = 0)
D1	0
D0	0

If R/W = 1, the TDA7566 sends 4 "Diagnostics Bytes" to mP: DB1, DB2, DB3 and DB4.

**Table 8. DB1**

Bit	Instruction decoding bit
D7	Thermal warning active (D7 = 1)
D6	Diag. cycle not activated or not terminated (D6 = 0) Diag. cycle terminated (D6 = 1)
D5	Channel LF Current detection Output peak current < 250mA - Open load (D5 = 1) Output peak current > 500mA - Open load (D5 = 0)
D4	Channel LF Turn-on diagnostic (D4 = 0) Permanent diagnostic (D4 = 1)
D3	Channel LF Normal load (D3 = 0) Short load (D3 = 1)
D2	Channel LF Turn-on diag.: No open load (D2 = 0) Open load detection (D2 = 1) Offset diag.: No output offset (D2 = 0) Output offset detection (D2 = 1)
D1	Channel LF No short to Vcc (D1 = 0) Short to Vcc (D1 = 1)
D0	Channel LF No short to GND (D1 = 0) Short to GND (D1 = 1)

**Table 9. DB2**

Bit	Instruction decoding bit
D7	Offset detection not activated (D7 = 0) Offset detection activated (D7 = 1)
D6	Current sensor not activated (D6 = 0) Current sensor activated (D6 = 1)
D5	Channel LR Current detection Output peak current < 250mA - Open load (D5 = 1) Output peak current > 500mA - Open load (D5 = 0)
D4	Channel LR Turn-on diagnostic (D4 = 0) Permanent diagnostic (D4 = 1)
D3	Channel LR Normal load (D3 = 0) Short load (D3 = 1)
D2	Channel LR Turn-on diag.: No open load (D2 = 0) Open load detection (D2 = 1) Permanent diag.: No output offset (D2 = 0) Output offset detection (D2 = 1)
D1	Channel LR No short to Vcc (D1 = 0) Short to Vcc (D1 = 1)
D0	Channel LR No short to GND (D1 = 0) Short to GND (D1 = 1)

**Table 10. DB3**

Bit	Instruction decoding bit
D7	Standby status (= IB1 - D4)
D6	Diagnostic status (= IB1 - D6)
D5	Channel RF Current detection Output peak current < 250mA - Open load (D5 = 1) Output peak current > 500mA - Open load (D5 = 0)
D4	Channel RF Turn-on diagnostic (D4 = 0) Permanent diagnostic (D4 = 1)
D3	Channel RF Normal load (D3 = 0) Short load (D3 = 1)
D2	Channel RF Turn-on diag.: No open load (D2 = 0) Open load detection (D2 = 1) Permanent diag.: No output offset (D2 = 0) Output offset detection (D2 = 1)
D1	Channel RF No short to Vcc (D1 = 0) Short to Vcc (D1 = 1)
D0	Channel RF No short to GND (D1 = 0) Short to GND (D1 = 1)



Table 11. DB4

Bit	Instruction decoding bit
D7	X
D6	X
D5	Channel R Current detection Output peak current < 250 mA - Open load (D5 = 1) Output peak current > 500 mA - Open load (D5 = 0)
D4	Channel RR Turn-on diagnostic (D4 = 0) Permanent diagnostic (D4 = 1)
D3	Channel RR Normal load (D3 = 0) Short load (D3 = 1)
D2	Channel RR Turn-on diag.: No open load (D2 = 0) Open load detection (D2 = 1) Permanent diag.: No output offset (D2 = 0) Output offset detection (D2 = 1)
D1	Channel RR No short to Vcc (D1 = 0) Short to Vcc (D1 = 1)
D0	Channel RR No short to GND (D1 = 0) Short to GND (D1 = 1)

## 7 Examples of bytes sequence

### 1 - Turn-on diagnostic - Write operation

Start	Address byte with D0 = 0	ACK	IB1 with D6 = 1	ACK	IB2	ACK	STOP
-------	--------------------------	-----	-----------------	-----	-----	-----	------

### 2 - Turn-on diagnostic - Read operation

Start	Address byte with D0 = 1	ACK	DB1	ACK	DB2	ACK	DB3	ACK	DB4	ACK	STOP
-------	--------------------------	-----	-----	-----	-----	-----	-----	-----	-----	-----	------

The delay from 1 to 2 can be selected by software, starting from 1ms

### 3a - Turn-on of the power amplifier with 26dB gain, mute on, diagnostic defeat.

Start	Address byte with D0 = 0	ACK	IB1	ACK	IB2	ACK	STOP
			X000000X		XXX1X0XX		

### 3b - Turn-off of the power amplifier

Start	Address byte with D0 = 0	ACK	IB1	ACK	IB2	ACK	STOP
			X0XXXXXX		XXX0XXXX		

### 4 - Offset detection procedure enable

Start	Address byte with D0 = 0	ACK	IB1	ACK	IB2	ACK	STOP
			XX1XX11X		XXX1X0XX		

### 5 - Offset detection procedure stop and reading operation (the results are valid only for the offset detection bits (D2 of the bytes DB1, DB2, DB3, DB4).

Start	Address byte with D0 = 1	ACK	DB1	ACK	DB2	ACK	DB3	ACK	DB4	ACK	STOP
-------	--------------------------	-----	-----	-----	-----	-----	-----	-----	-----	-----	------

- The purpose of this test is to check if a D.C. offset (2V typ.) is present on the outputs, produced by input capacitor with anomalous leakage current or humidity between pins.
- The delay from 4 to 5 can be selected by software, starting from 1ms

### 6 - Current detection procedure start (the AC inputs must be with a proper signal that depends on the type of load)

Start	Address byte with D0 = 0	ACK	IB1	ACK	IB2	ACK	STOP
			XX01111X		XXX1X1XX		

### 7 - Current detection reading operation (the results valid only for the current sensor detection bits - D5 of the bytes DB1, DB2, DB3, DB4).

Start	Address byte with D0 = 1	ACK	DB1	ACK	DB2	ACK	DB3	ACK	DB4	ACK	STOP
-------	--------------------------	-----	-----	-----	-----	-----	-----	-----	-----	-----	------

- During the test, a sinus wave with a proper amplitude and frequency (depending on the loudspeaker under test) must be present. The minimum number of periods that are needed to detect a normal load is 5.
- The delay from 6 to 7 can be selected by software, starting from 1ms.

# 8 Package information

In order to meet environmental requirements, ST offers these devices in different grades of ECOPACK® packages, depending on their level of environmental compliance. ECOPACK® specifications, grade definitions and product status are available at: [www.st.com](http://www.st.com).

ECOPACK® is an ST trademark.

**Figure 28. Flexiwatt25 mechanical data and package dimensions**

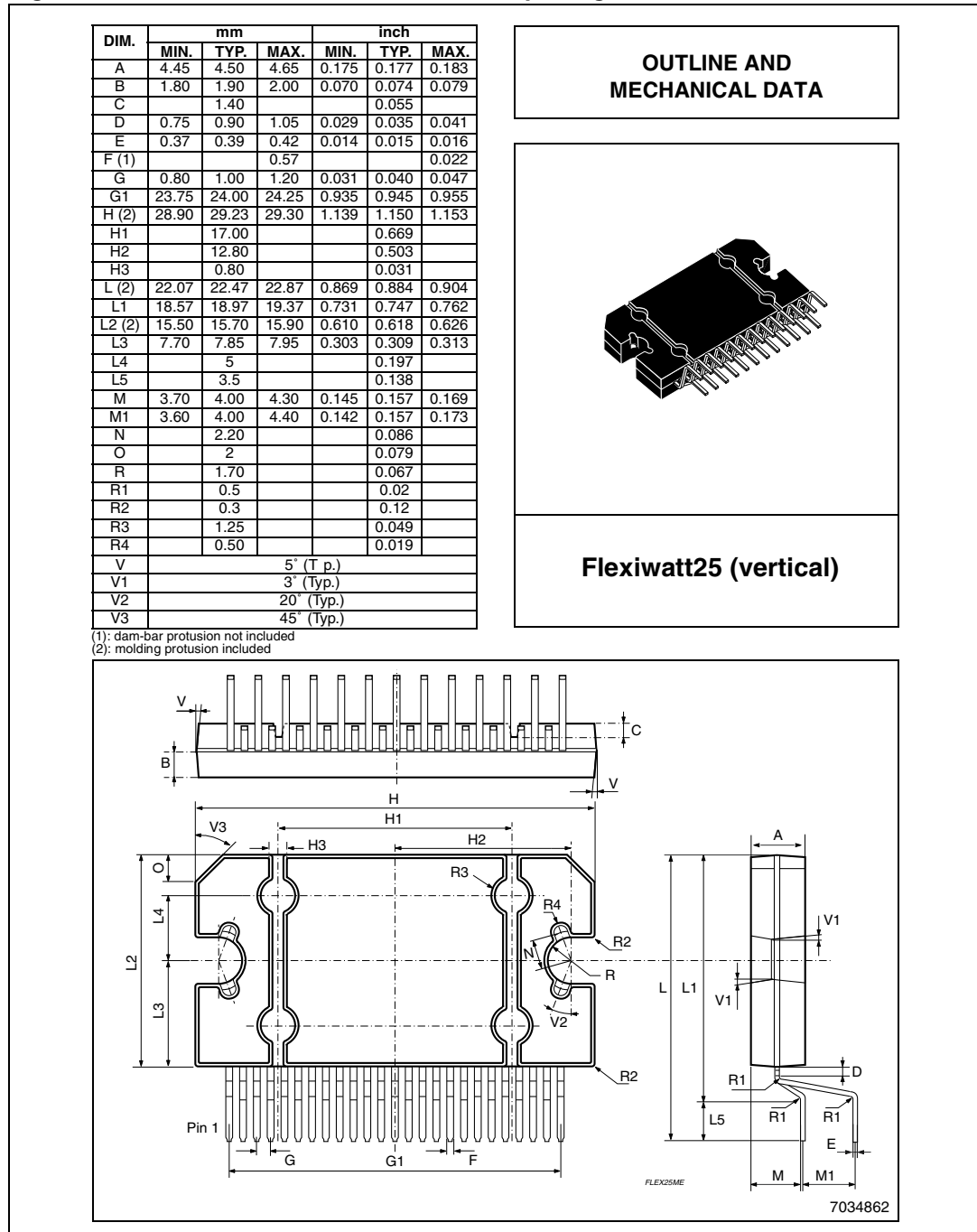

## 9 Revision history

**Table 12. Document revision history**

Date	Revision	Changes
20-Sep-2003	1	Initial release.
12-Jul-2006	2	Document reformatted. Corrected the values of $I_{NL}$ and $I_{OL}$ parameters in the <a href="#">Table 4: Electrical characteristics</a> .
18-Dec-2006	3	Updated <a href="#">Figure 20</a> and <a href="#">21</a> .
29-Sep-2008	4	Updated <a href="#">Table 4: Electrical characteristics</a> . Updated <a href="#">Figure 20</a> .
11-Oct-2010	5	Modified <a href="#">Table 1: Device summary on page 1</a> .
17-Sep-2013	6	Updated Disclaimer.

**Please Read Carefully:**

Information in this document is provided solely in connection with ST products. STMicroelectronics NV and its subsidiaries ("ST") reserve the right to make changes, corrections, modifications or improvements, to this document, and the products and services described herein at any time, without notice.

All ST products are sold pursuant to ST's terms and conditions of sale.

Purchasers are solely responsible for the choice, selection and use of the ST products and services described herein, and ST assumes no liability whatsoever relating to the choice, selection or use of the ST products and services described herein.

No license, express or implied, by estoppel or otherwise, to any intellectual property rights is granted under this document. If any part of this document refers to any third party products or services it shall not be deemed a license grant by ST for the use of such third party products or services, or any intellectual property contained therein or considered as a warranty covering the use in any manner whatsoever of such third party products or services or any intellectual property contained therein.

**UNLESS OTHERWISE SET FORTH IN ST'S TERMS AND CONDITIONS OF SALE ST DISCLAIMS ANY EXPRESS OR IMPLIED WARRANTY WITH RESPECT TO THE USE AND/OR SALE OF ST PRODUCTS INCLUDING WITHOUT LIMITATION IMPLIED WARRANTIES OF MERCHANTABILITY, FITNESS FOR A PARTICULAR PURPOSE (AND THEIR EQUIVALENTS UNDER THE LAWS OF ANY JURISDICTION), OR INFRINGEMENT OF ANY PATENT, COPYRIGHT OR OTHER INTELLECTUAL PROPERTY RIGHT.**

**ST PRODUCTS ARE NOT DESIGNED OR AUTHORIZED FOR USE IN: (A) SAFETY CRITICAL APPLICATIONS SUCH AS LIFE SUPPORTING, ACTIVE IMPLANTED DEVICES OR SYSTEMS WITH PRODUCT FUNCTIONAL SAFETY REQUIREMENTS; (B) AERONAUTIC APPLICATIONS; (C) AUTOMOTIVE APPLICATIONS OR ENVIRONMENTS, AND/OR (D) AEROSPACE APPLICATIONS OR ENVIRONMENTS. WHERE ST PRODUCTS ARE NOT DESIGNED FOR SUCH USE, THE PURCHASER SHALL USE PRODUCTS AT PURCHASER'S SOLE RISK, EVEN IF ST HAS BEEN INFORMED IN WRITING OF SUCH USAGE, UNLESS A PRODUCT IS EXPRESSLY DESIGNATED BY ST AS BEING INTENDED FOR "AUTOMOTIVE, AUTOMOTIVE SAFETY OR MEDICAL" INDUSTRY DOMAINS ACCORDING TO ST PRODUCT DESIGN SPECIFICATIONS. PRODUCTS FORMALLY ESCC, QML OR JAN QUALIFIED ARE DEEMED SUITABLE FOR USE IN AEROSPACE BY THE CORRESPONDING GOVERNMENTAL AGENCY.**

Resale of ST products with provisions different from the statements and/or technical features set forth in this document shall immediately void any warranty granted by ST for the ST product or service described herein and shall not create or extend in any manner whatsoever, any liability of ST.

ST and the ST logo are trademarks or registered trademarks of ST in various countries.

Information in this document supersedes and replaces all information previously supplied.

The ST logo is a registered trademark of STMicroelectronics. All other names are the property of their respective owners.

© 2013 STMicroelectronics - All rights reserved

STMicroelectronics group of companies

Australia - Belgium - Brazil - Canada - China - Czech Republic - Finland - France - Germany - Hong Kong - India - Israel - Italy - Japan - Malaysia - Malta - Morocco - Philippines - Singapore - Spain - Sweden - Switzerland - United Kingdom - United States of America

[www.st.com](http://www.st.com)